

EPSON® PowerLite® 500c/700c/710c Multimedia Projector



User's Guide ***Supplement***

Important Safety Information

WARNING: Never look into the projector lens when the lamp is turned on; the bright light can damage your eyes. Never let children look into the lens when it is on. Never open any cover on the projector, except the lamp and filter covers. Dangerous electrical voltages inside the projector can severely injure you. Except as specifically explained in the User's Guide or this Supplement, do not attempt to service this product yourself. Refer all servicing to qualified service personnel.

WARNING: The projector and its accessories come packaged in plastic bags. Keep plastic bags away from small children to avoid any risk of suffocation.

Caution: When you replace the lamp, never touch the new lamp with your bare hands; the invisible residue left by the oil on your hands may shorten the lamp life. Use a cloth or glove to handle the new lamp.

Copyright Notice

All rights reserved. No part of this publication may be reproduced, stored in a retrieval system, or transmitted in any form or by any means, electronic, mechanical, photocopying, recording, or otherwise, without the prior written permission of SEIKO EPSON CORPORATION. The information contained herein is designed only for use with this EPSON printer. EPSON is not responsible for any use of this information as applied to other printers.

Neither SEIKO EPSON CORPORATION nor its affiliates shall be liable to the purchaser of this product or third parties for damages, losses, costs, or expenses incurred by purchaser or third parties as a result of: accident, misuse, or abuse of this product or unauthorized modifications, repairs, or alterations to this product, or (excluding the U.S.) failure to strictly comply with SEIKO EPSON CORPORATION's operating and maintenance instructions.

SEIKO EPSON CORPORATION shall not be liable for any damages or problems arising from the use of any options or any consumable products other than those designated as Original EPSON Products or EPSON Approved Products by SEIKO EPSON CORPORATION.

EPSON is a registered trademark of SEIKO EPSON CORPORATION.

PowerLite is a registered trademark of Epson America, Inc.

General Notice: Other product names used herein are for identification purposes only and may be trademarks of their respective owners. EPSON disclaims any and all rights in those marks.

C

Contents

Connecting to a Desktop Computer

Positioning the Projector	5
Identifying the Projector Ports	7
Connecting to a PC Desktop Computer	7
Connecting the Computer Cable	8
Connecting the Audio Cable	9
Connecting the Cable for Remote Mouse Control	9
Connecting to a Desktop Macintosh	10
Connecting the Computer Cable	11
Connecting the Audio Cable	13
Connecting the Cable for Remote Mouse Control	13
Turning the Projector On and Off	14
Turning On Other Equipment	16

Using the Projector Menus

Changing Menu Settings	18
Video Menu (Computer Image Source)	20
Video Menu (Video Image Source)	22
Audio Menu	23
Effect Menu	24
Setting Menu	25
User's Logo Feature	26
Capturing the Image	26
Assigning the Image to the No-Signal Message and/or A/V Mute Button	29
Advanced Menu	30
About Menu (Computer Image Source)	31
About Menu (Video Image Source)	32
Reset All Feature	32

*Technical
Specifications*

General	33
Projection Lamp	34
Remote Control	34
Mouse Compatibility	34
Remote IR Receiver	34
Mechanical	34
Electrical	34
Environmental	34
Safety	35
CE Marking	35
Supported Monitor Displays	35
Computer Connector Pin Assignments	37

Index

A Appendix A: Connecting to a Desktop Computer

note

*For instructions on connecting to a laptop computer or to external speakers, see your *User's Guide*.*

This appendix describes how to connect the projector to your desktop computer and turn everything on. The projector must be connected to a computer or a video source such as a VCR, camcorder, digital camera, DVD player, or laser disc player before it can project any images. You may also want to set up the projector for one or more of the following:

- Connect the mouse cable to use the remote control as a wireless mouse. Except for some laptops, this disables your computer's mouse. You use the remote control's pointer to control the screen cursor.
- Provide audio for one or both image sources. The audio source can be the computer, video source, or another device such as a stereo.
- Connect to an external speaker or PA system to amplify the audio (see your *User's Guide* for instructions).

Positioning the Projector

Before you can set up the projector, you need to decide where to place it. Keep the following in mind:

- Place the projector on a sturdy, level surface.
- Make sure the projector is within 10 feet of a grounded electrical outlet or extension cord.
- Place the computer and/or video source within 5 feet of the projector.
- Make sure the projector is at right angles to the screen. Otherwise, your image will be distorted.

note

It is easier to position the projector when the screen is directly in front of the room. If the screen is placed diagonally in a corner, it is much more difficult to position the projector perpendicular to the screen and get a non-distorted image.

Most presenters find it convenient to place the projector (and computer) in the front of the room. With this arrangement, the projector is placed close to the screen. You need to raise the front of the projector (by extending the legs) in order to position the image high enough on the screen. Then you can use the projector's keystone control to correct the distortion caused by tilting up the front of the projector.

The distance between the projector and the screen determines the actual image size. Use the general guidelines in the table below to determine the proper distance.

Image size (diagonal)	Horizontal distance from projector to screen	
	Minimum (lens set to W)	Maximum (lens set to T)
2.2 feet (0.7 meter)	—	3.6 feet (1.1 meters)
2.5 feet (0.8 meter)	3.6 feet (1.1 meters)	4.3 feet (1.3 meter)
3.3 feet (1.0 meter)	4.8 feet (1.5 meters)	5.6 feet (1.7 meters)
5.0 feet (1.5 meters)	7.5 feet (2.3 meters)	8.9 feet (2.7 meters)
6.7 feet (2.0 meters)	9.8 feet (3.0 meters)	11.8 feet (3.6 meters)
8.3 feet (2.5 meters)	12.5 feet (3.8 meters)	14.8 feet (4.5 meters)
12.5 feet (3.8 meters)	18.7 feet (5.7 meters)	22.6 feet (6.9 meters)
16.7 feet (5.1 meters)	25.3 feet (7.7 meters)	30.2 feet (9.2 meters)
25 feet (7.6 meters)	37.7 feet (11.5 meters)	45.3 feet (13.8 meters)

Identifying the Projector Ports

The following illustrations identify all the interface ports on the back and side of the projector; you may want to refer to them as you connect your computer or other equipment to the projector.

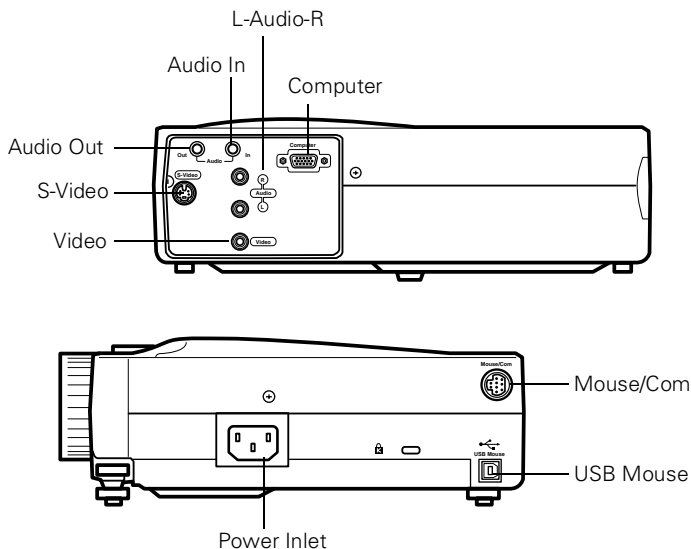

Connecting to a PC Desktop Computer

To connect the projector to your PC desktop computer, you need to:

- Connect the computer cable
- Connect the audio cable (if you'll be projecting with audio)
- Connect the mouse cable (if you want to use the remote control as a mouse)

note

Computer configurations vary. See your computer manual for the location of the ports needed to connect your projector.

If you connect the projector to your desktop computer, you cannot view your images on the computer monitor.

Follow the steps in each section for the cables you need to connect.

Connecting the Computer Cable

Before you start, make sure your projector, computer, and all peripherals are all turned off.

1. Disconnect the monitor cable from the monitor port on the back of your computer.
2. Connect one end of the projector's computer cable to the projector's Computer port.

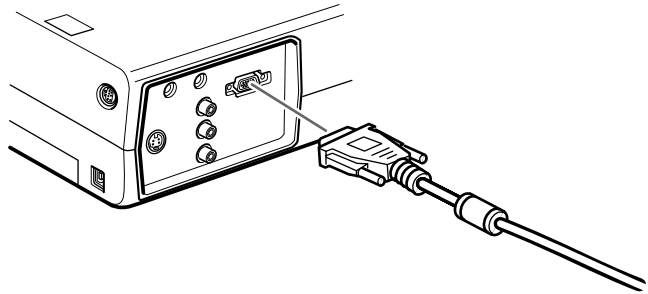

3. Connect the other end of the cable to your computer's video (monitor) port.

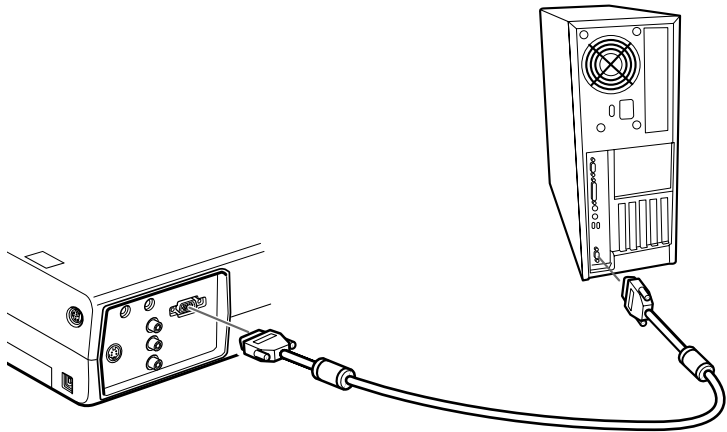

4. Tighten the screws on all connectors.

If you don't need to make any other connections, you can plug in your projector and turn it on. See page 14 for instructions.

note

If you need maximum volume (in a large auditorium, for example), you can also connect external speakers or a public address system to the projector. See your User's Guide for instructions.

Connecting the Audio Cable

If your presentation includes sound effects or other types of computer audio, you need to connect the audio cable.

1. Connect one end of the audio cable to the **Audio In** jack on the projector.

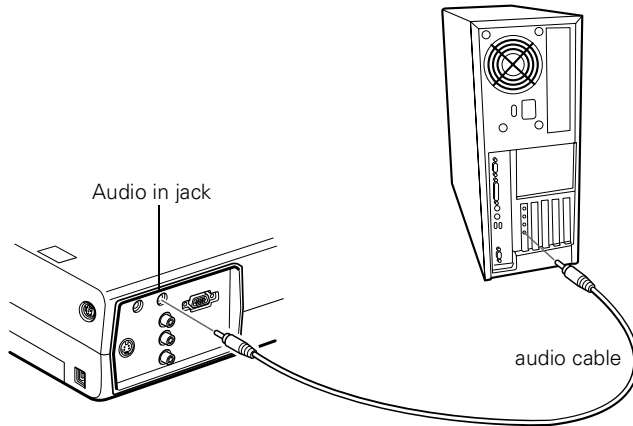

2. Connect the other end of the audio cable to the speaker or audio out port on your computer's sound card.

Connecting the Cable for Remote Mouse Control

Using the remote control as a wireless mouse gives you more flexibility. You can deliver your presentation from anywhere in the room and interact with the audience. You don't need to stand near your computer or near the projector.

You'll use different cables and different ports on the projector, depending on whether your computer has a round PS/2 mouse port or a flat USB mouse port.

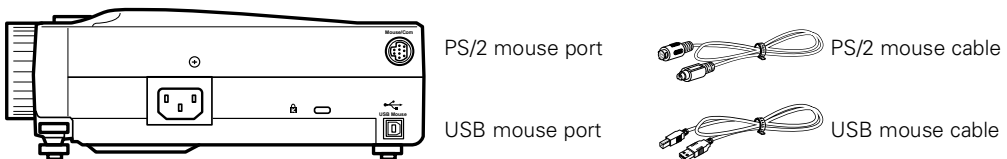

1. Determine which type of mouse port your computer has:
 - Round PS/2 mouse port
 - Flat USB mouse port
2. Connect one end of the appropriate mouse cable to the PS/2 Mouse/Com port or the USB Mouse port on the projector.

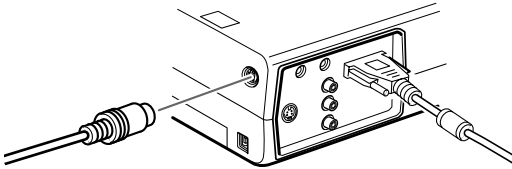

connecting PS/2 mouse cable

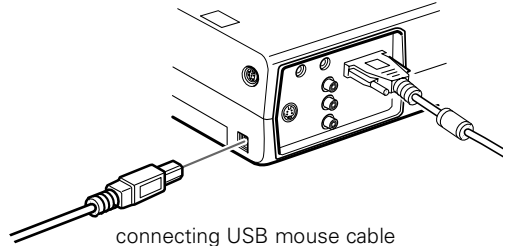

connecting USB mouse cable

3. Connect the other end to the mouse port on your computer. (Your computer's mouse will be disabled while you are using the remote control as a mouse.)

Connecting to a Desktop Macintosh

note

Macintosh configurations vary. See your computer manual for the location of the ports needed to connect your projector.

To connect the projector to your desktop Macintosh,[®] you need to:

- Connect the computer cable
- Connect the audio cable (if you'll be projecting with audio)
- Connect the mouse cable (if you want to use the remote control as a mouse)

If you connect the projector to your Macintosh, you cannot view your images on the computer monitor.

Follow the steps in each section for the cables you need to connect.

Connecting the Computer Cable

Before you start, make sure your projector, computer, and all peripherals are all turned off.

note

If you have an older Macintosh, you may need to use a Macintosh adapter (available from Apple®). Check the documentation for your Macintosh to determine what type of connections are available.

1. Disconnect the monitor cable from the monitor port on the back of your Macintosh.
2. Connect one end of the computer cable to the projector's Computer port.

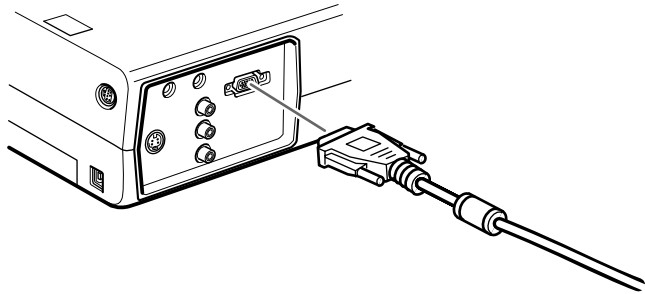

3. Connect the other end to the monitor port on your Macintosh.

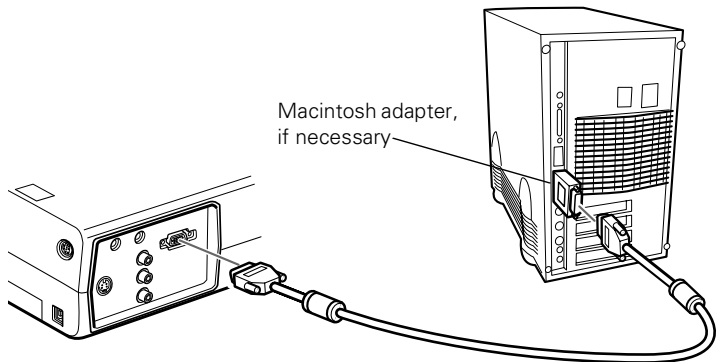

If you can't connect the projector's computer cable to your Macintosh, you may need to use a Macintosh adapter (available from Apple).

- Remove the small cover on the Macintosh adapter and set its DIP switches according to the resolution you want to use (such as 16-inch mode). See your Macintosh documentation for instructions.

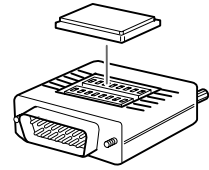

- Connect the small end of the Macintosh adapter to the computer cable.
- Connect the computer cable (with the Macintosh adapter attached) to the monitor port on your Macintosh.

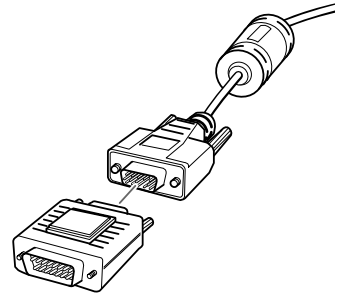

4. Tighten the screws on all the connectors.

If you don't need to make any other connections, you can plug in your projector and turn it on. See page 14 for instructions.

note

If you need maximum volume (in a large auditorium, for example), you can also connect external speakers or a public address system to the projector. See your User's Guide for instructions.

Connecting the Audio Cable

If your presentation includes sound effects or other types of computer audio, you need to connect the audio cable.

1. Connect one end of the audio cable to the **Audio In** jack on the projector.

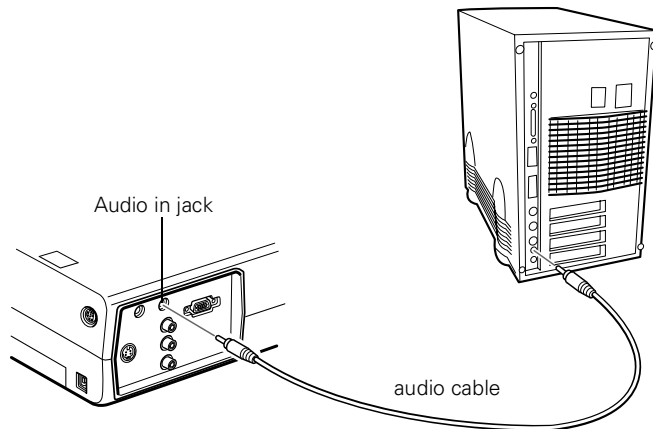

2. Connect the other end of the audio cable to the speaker jack on your Macintosh.

Connecting the Cable for Remote Mouse Control

Using the remote control as a wireless mouse gives you more flexibility. You can deliver your presentation from anywhere in the room and interact with the audience. You don't need to stand near your Macintosh or near the projector.

You'll use different cables and different ports on the projector, depending on what type of mouse your Macintosh has.



1. Determine which type of mouse port your Macintosh has:
 - Round mouse port
 - Flat USB mouse port
2. Connect one end of the appropriate mouse cable to the standard **Mouse/Com** port or the **USB Mouse** port on the projector.

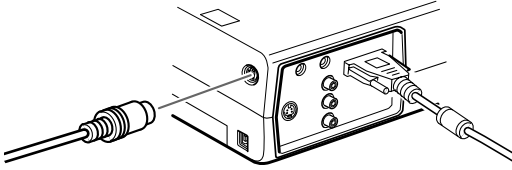

connecting Mac mouse cable

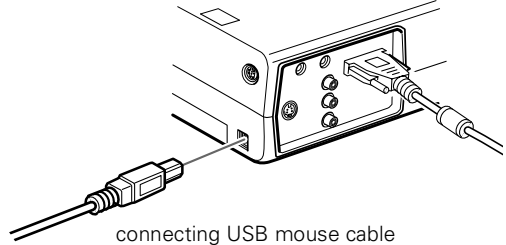

connecting USB mouse cable

3. Connect the other end to the port on your Macintosh.

Turning the Projector On and Off

After you have connected your computer and other equipment, you can plug in the projector and turn it on.

1. Connect the power cable to your projector's power inlet.

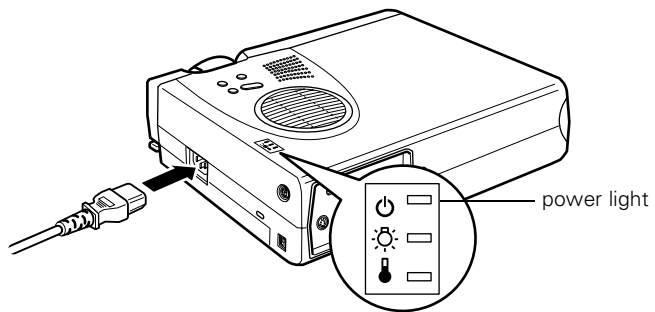

2. Plug the other end of the cable into a grounded electrical outlet.

The power light on top of the projector turns orange. This indicates that the projector is receiving power, but is not yet turned on.

- Use the tab on the lens ring to rotate the ring and pop out the lens.

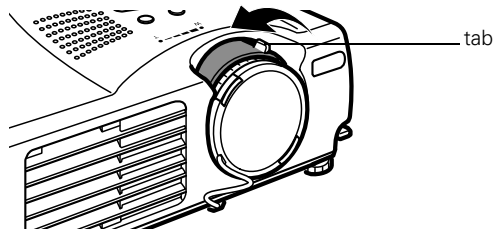

- Squeeze the lens cap tabs and remove the lens cap.

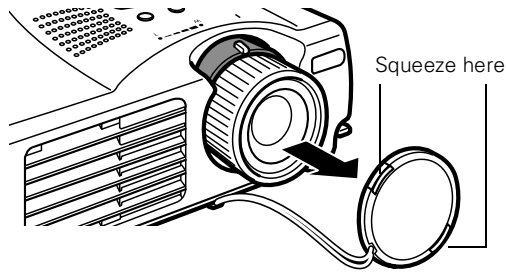

warning

Never look into the lens when the lamp is on. This can damage your eyes, and is especially dangerous for children.

- Press the red Power button on top of the projector.

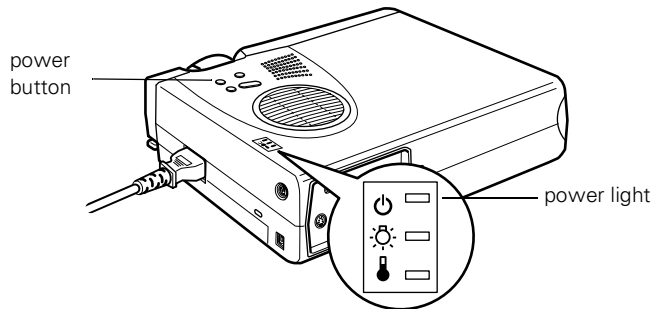

The power light flashes green, and then stays on. You may see a blue screen with the message **No Signal** displayed. This is normal.

- Turn on or restart your computer. In a few moments, you should see the computer display projected.

When you are ready to turn off the projector, follow these steps:

1. Press the red **Power** button on top of the projector. You see a confirmation message. (If you don't want to turn it off, press any other button.)
2. Press the **Power** button again. The Power light flashes orange for about a minute and the fan gets louder as the projector cools down. When the projector has cooled, the orange light stays on and the fan shuts off.

If you want to turn the projector on again, wait until the orange light stops flashing. Then press the **Power** button.

3. When you are finished using the projector, replace the lens cap, retract the lens, and unplug the power cord.

caution

To avoid damaging the lamp, never unplug the power cord when the power light is green.

Turning On Other Equipment

If you're using a VCR, other external video source, or additional equipment with the projector, turn on the equipment in this order:

1. Video source
2. External audio source
3. Projector
4. External speakers or PA system
5. Computer

When you're ready to shut down, turn off the equipment in the reverse order.

B Appendix B: *Using the Projector Menus*

The on-screen menus let you customize and adjust projector features. The following 8 menus and features are available:

- **Video**
Controls the look and quality of the projected image (from a computer or video source).
- **Audio**
Adjusts the volume and tone (treble/bass).
- **Effect**
Customizes the drawing tools available on the remote control.
- **Setting**
Adjusts features such as the keystone setting, blank screen color, message prompt, and power management system.
- **User's Logo**
Lets you capture and store an image to be displayed with the A/V Mute button, or as the startup screen.
- **Advanced**
Controls settings such as menu language, use of startup screen, color temperature, and rear or ceiling projection.
- **About**
Provides information about lamp usage and the current display settings.
- **Reset All**
Restores the factory defaults for all the projector settings.

Changing Menu Settings

You use the **Menu**, **Enter** and **Esc** buttons on the remote control to change menu settings.

To change a menu setting:

1. To access the menu system, open the cover on the lower part of the remote control and press the **Menu** button.

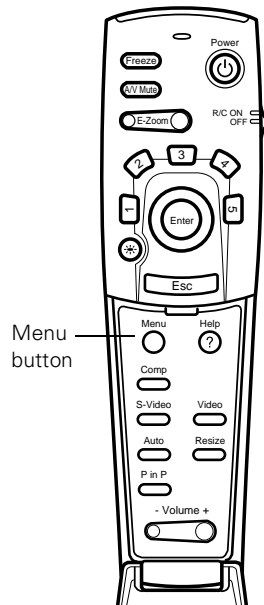

You see the following:

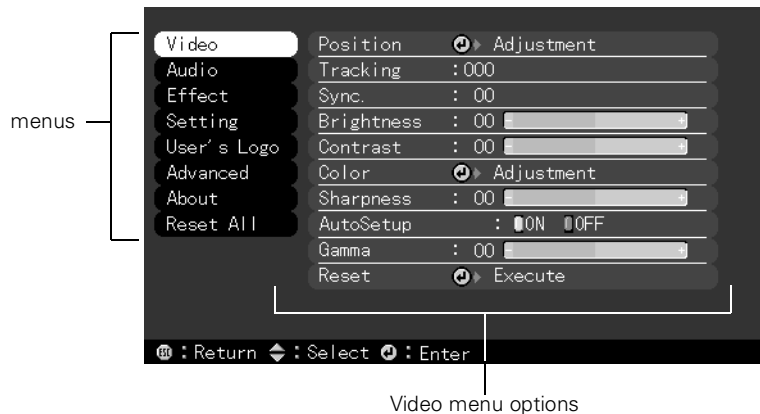

note

The options available in some submenus vary, depending on whether the current image source is the computer or a video source.

As you select a menu, a submenu of options appears to the right.



2. Press the bottom of the **Enter** button (or grasp it between your thumb and finger and tilt it down) to scroll through the menus.

When you highlight a menu, its options are shown on the right.

3. When the menu you want is highlighted, press the center of the **Enter** button to select it.

The highlight moves to the first option for that menu.

4. Press the bottom of the **Enter** button (or grasp it between your thumb and finger and tilt it down) to scroll through the options.
5. Press the right or left side of the **Enter** button (or grasp it between your thumb and finger and tilt it to the side) to change the setting.
6. If you want to go back to the default settings on any menu, select **Reset**, press **Enter**, select **Yes**, and then press **Enter**.
7. Press the **Esc** button on the remote to go back to the main menu display. Your changes are saved automatically.
8. Press the **Menu** button to exit the menu system.

The settings available in each of the menus are described below.

Video Menu (Computer Image Source)

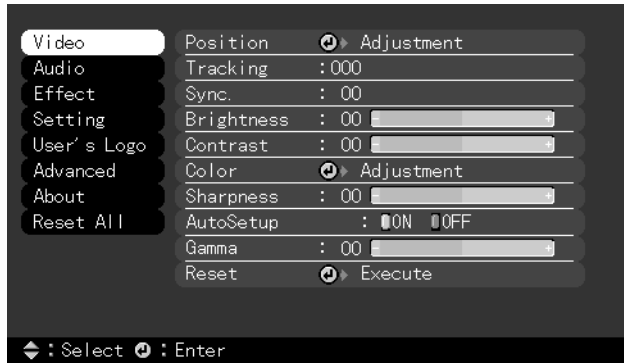

note

Some options are limited to being enabled (turned on) or disabled (turned off).

The computer must be connected and operating, and the image source on the projector must be set to Computer for you to access these menu options.

The Video menu lets you make adjustments to the projected image. The following options are available when the image source is your computer.

Menu item	Description
Position	Use the Enter button to move the screen position in the corresponding direction. When you finish making adjustments, press the Esc button.
Tracking	Matches the projector's internal clock to various computer graphic signals. Adjust this setting to remove vertical lines from the image.
Sync	Synchronizes with the tracking signal sent from the computer. Adjust this setting to correct fuzziness or screen flicker.
Brightness	Lightens or darkens the overall image. Increase brightness to lighten an image, or decrease it to darken the image.
Contrast	Adjusts the difference between light and dark areas. Increase the contrast to make light areas lighter and dark areas darker. Decrease it to minimize the difference between light and dark areas.

Menu item	Description
Color	<p>Adjusts the color balance (red:green:blue) of the input source.</p> <p>Increase the color setting for more intense color on the screen, and lower the setting for less intense color.</p> <p>When you finish making adjustments, press the Esc button.</p>
Sharpness	Adjusts the sharpness of the screen image.
Auto Setup	Set to On to have the computer automatically optimize the image for projection.
Gamma	Adjusts the projected image for natural coloration.
Reset	Returns all menu items to their initial factory defaults.

Video Menu (Video Image Source)

The Video menu lets you make adjustments to the projected image. The following options are available when the image source is Video.

note

The projector's image source must be set to Video, and the video source (such as a VCR or camcorder) must be connected and operating for you to access these menu options. For example, the projector must actually be projecting the image from your video tape if you're using a VCR.

Menu item	Description
Position	Use the Enter button to move the screen position in the corresponding direction. When you finish making adjustments, press the Esc button.
Brightness	Lightens or darkens the overall image. Increase brightness to lighten an image, or decrease it to darken the image.
Contrast	Adjusts the degree of difference between light and dark areas. Increase the contrast to make light areas lighter and dark areas darker. Decrease it to minimize the difference between the lightest and darkest areas of the image.
Color	Adjusts color density. Increase the setting for darker and more opaque colors. Decrease it for lighter and less opaque colors.
Tint (NTSC only)	Adjusts the red-green color balance of the screen. Increase tint to add more green, or decrease it to add more red.
Sharpness	Adjusts the sharpness of the screen image.
Gamma	Adjusts the projected image for natural coloration.
Mode	Specifies the image signal mode: Auto, NTSC, NTSC4.43, PAL, M-PAL, N-PAL, PAL 60, SECAM.
Reset	Returns all menu items to their initial factory defaults.

Audio Menu



Use the Audio menu to adjust the sound volume and quality of your audio.

Menu item	Description
Volume	Adjusts the volume level for the projector's speaker and audio-out terminal. Increase the setting to raise the volume, or decrease it to lower the volume.
Tone	Adjusts the sound quality. Move left to increase bass and right to increase treble.
Reset	Returns all menu items to their initial factory defaults.

Effect Menu



The Effect menu lets you customize the drawing tools available on the remote control.

Menu item	Description
Cursor/Stamp	Selects the stamp you want to use as the cursor graphic and lets you enlarge it.
Box	Selects a box color and shape.
Marker	Selects the marker (horizontal or vertical lines) color and width (from 2 to 32 pixels).
Freehand	Selects the color and width for freehand lines (2 to 148 pixels).
Cursor Speed	Adjusts the cursor speed to Low, Middle, or High.
Reset	Returns all menu items to their initial factory defaults.

Setting Menu

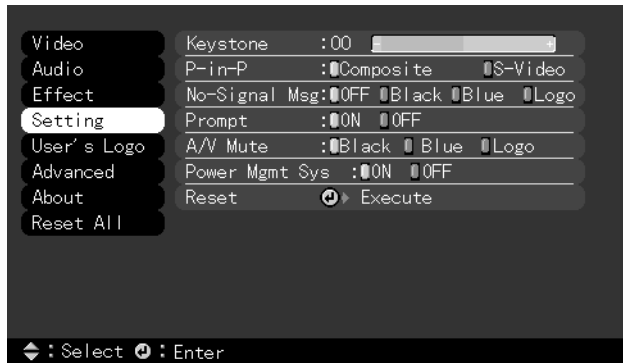

The Setting menu allows you to set or adjust various projector options.

Menu item	Description
Keystone	Adjusts a trapezoid (distorted) image to a 4:3 rectangle, correcting up to a $\pm 15^\circ$ tilt.
P-in-P	Selects the image source (composite or S-Video) for the picture-in-picture subscreen.
No-Signal Msg	Specifies whether no screen, a black screen, a blue screen, or a user logo is displayed when the projector is not receiving a signal.
Prompt	Turns off the message identifying the image source (computer or video).
A/V Mute	Specifies whether a blue, black, or user logo screen is displayed when the A/V mute button is pressed.
Power Mgmt Sys	Turns on the power management system which works with your computer's power management.
Reset	Returns all menu items to their initial factory defaults.

User's Logo Feature

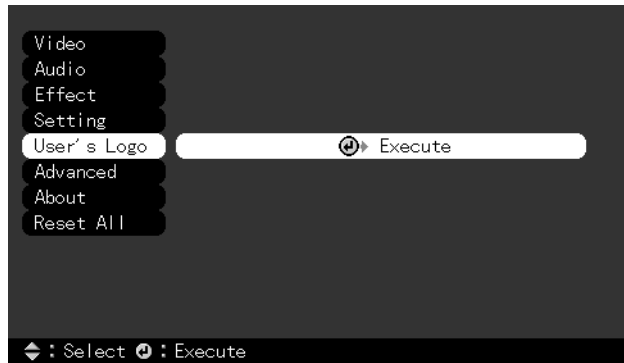

The User's Logo feature allows you to transfer any image on your computer to the projector, and then use it as the screen displayed when the projector is not receiving a signal. You can also set it as a startup screen or to be displayed when you press the A/V Mute button on the remote. The image can be a company logo, slogan, photograph, or another other image you want to use.

Capturing the Image

You start by displaying the image you want to use on the projector. You can use an image from either a computer or video source such as a VCR or digital camera. Then follow these steps to capture the image and transfer it to the projector:

1. Press the **Menu** button. You see the main menu listing, with the **Video** menu highlighted.
2. Press the bottom edge of the **Enter** button (or move it down) to highlight the **User's Logo** menu.

3. Press **Enter** to select this feature. You see the following message:



4. Select **Yes** and press **Enter**. A selection box displays over the image.
5. Use the **Enter** button on the remote control to select the area of the image you want to use. Once you have selected the entire area, press **Enter**.
6. When you see the message "Do you use this image?" select **Yes** and press **Enter**. If you want to change the area selected, select **No** and repeat step 5. You see the following:

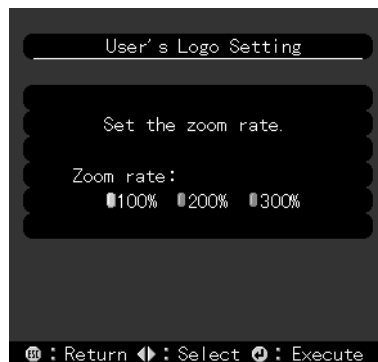

7. Use the **Enter** button on the remote control to select a zoom rate (display size), and then press **Enter**.

- When the following message appears, select **Yes** and press **Enter**.



Saving the logo may take a few moments. Do not use the projector or other sources (computer, video, speaker, etc.) while the logo is being saved.

- When you see the following message, press the **Menu** or **Enter** button to redisplay the main menu.



note

You can also set up your image as a startup screen. Use the Advanced menu to enable the startup screen.

Assigning the Image to the No-Signal Message and/or A/V Mute Button

After your image is saved, you can set it up as the no-signal message and/or the screen that's displayed when you press the A/V Mute button.

1. Press the **Menu** button. You see the main menu listing, with the **Video** menu highlighted.
2. Press the bottom edge of the **Enter** button (or tilt it down) to highlight the **Setting** menu.
3. Press the **Enter** button to select the **Setting** menu.
4. Press the bottom edge of the **Enter** button (or tilt it down) to highlight **No-Signal Msg**.
5. Press the right side of the **Enter** button to select **Logo**. This sets your image as the screen displayed when the projector is not receiving a signal.
6. If you want to set up your image as the A/V mute display, press the bottom edge of the **Enter** button (or tilt it down) to highlight **A/V Mute**.
7. Press the right side of the **Enter** button to select **Logo**. This sets your image as the screen displayed when you press the **AV/Mute** button.
8. When you're finished, press **Esc** or **Menu**.

To test your setting, press the **A/V Mute** button to display your image. Press it again to turn off the image.

Advanced Menu

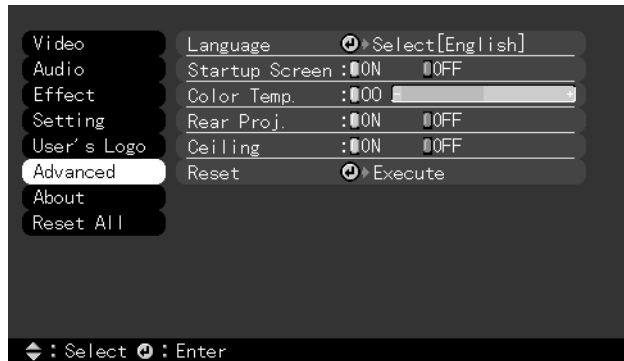

The Advanced menu lets you set additional projector options.

Menu item	Description
Language	Selects the language to be used in the menus: Japanese, English, French, German, Italian, Spanish, Portuguese, Chinese, or Korean.
Startup Screen	Displays the image you have saved as a user logo during the projector's startup.
Color Temp	Adjusts the whiteness of the screen. Positive color temperature values provide a cold white; negative values provide a warmer white.
Rear Proj.	Mirrors the projected image so it looks correct when you're projecting from behind onto a translucent screen. Selecting ON turns mirroring on, while OFF turns it off (for a normal image).
Ceiling	Flips the projected image so it looks correct when the projector is mounted upside-down from the ceiling. Selecting ON turns the feature on, while OFF turns it off (for a normal image).
Reset	Returns all Advanced menu items to their initial factory defaults.

About Menu (Computer Image Source)

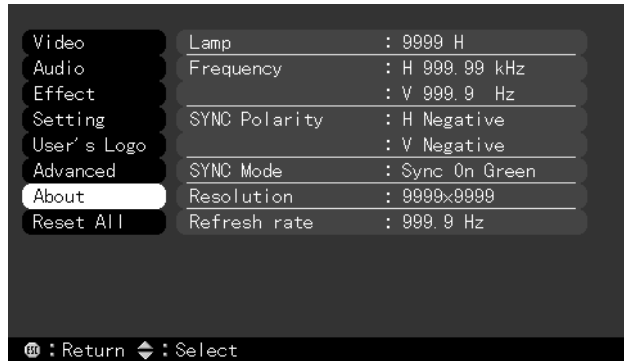

When the image source is a computer, the About menu displays information about the projector's horizontal and vertical frequency, lamp hours, and computer connection.

Menu item	Description
Lamp	Displays the number of hours the current lamp has been used.
Frequency	Displays the projector's horizontal and vertical frequency.
Sync Polarity	Displays the sync polarity of the computer.
Sync Mode	Displays the sync mode of the computer.
Resolution	Displays the output resolution of the computer video output.
Refresh Rate	Displays the refresh rate of the computer video output.

About Menu (Video Image Source)

When the image source is video, the About menu displays information about the projector's lamp hours and video signal.

Menu item	Description
Lamp	Displays the number of hours the current lamp has been used.
Video Signal	Displays the input image signal mode.

Reset All Feature

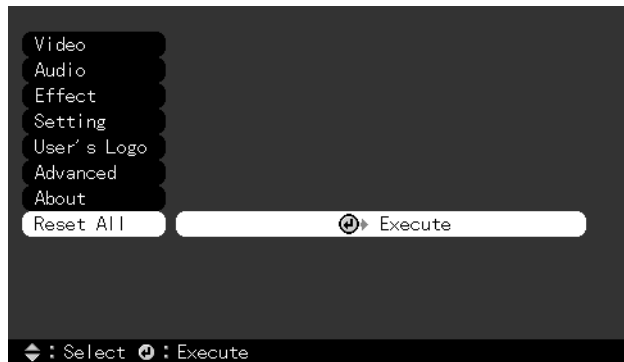

The Reset All feature lets you return all the projector settings to their default values. It does not change or delete any user logo you have stored.

Select **Reset All** and press the **Enter** button to display the confirmation screen. Select **Yes** to reset all the default settings or **No** to cancel.

C

Appendix C: Technical Specifications

General	Type of display	Poly-silicon Thin Film Transistor (TFT)
	Size of liquid crystal panels	Diagonal: 0.9 inch (22.9 mm)
	Lens	F=2.0–2.2, f=35–42 mm
	Resolution	500c: 800 × 600 pixels 700c: 1024 × 768 pixels 710c: 1024 × 768 pixels
	Color reproduction	24 bit, 16.7 million colors
	Brightness	500c: 800 lumens (ANSI) 700c: 800 lumens (ANSI) 710c: 1000 lumens (ANSI)
	Image size (diagonal)	2.2 to 25 feet (0.7 to 7.6 meters)
	Projection distance	3.6 to 45.3 feet (1.1 to 13.8 meters)
	Projection methods	Front, rear, upside-down (ceiling mount)
	Internal speaker system	1 monaural
	Optical aspect ratio	4:3 (horizontal:vertical)
	Zoom ratio	1.2:1
	Keystone correction angle	±15°
	Supported video interface standards	NTSC, NTSC4.43, PAL, PAL-M, PAL-N, PAL60, SECAM

Projection Lamp	Type	UHE (Ultra High Efficiency)
	Power consumption	120 W
	Lamp life	About 2000 hours
	Part number	ELPLP10S (710c) ELPLP10B (500c, 700c)
Remote Control	Range	32.8 feet (10 meters)
	Batteries	Alkaline AA (2)
Mouse Compatibility	Supports PS/2, USB, Macintosh	
Remote IR Receiver	Supports EPSON Remote IR Receiver, 10-foot cable (typical use for rear screen projection)	
Mechanical	Height	2.8 to 3.0 inches (72 to 77 mm)
	Width	8.4 inches (213 mm)
	Depth	10.5 inches (267 mm)
	Weight	5.8 lb (2.6 kg)
Electrical	Rated frequency	50/60 Hz
	Power supply	100 to 120 VAC, 2.4 A 200 to 240 VAC, 1.2 A
	Power consumption	Operating: 360 W Standby: 12 W
Environmental	Temperature	Operating: 41 to 104° F (5 to 40° C), non-condensing Storage: 14 to 140° F (-10 to 60° C), non-condensing
	Humidity	Operating: 20 to 80% RH, non-condensing Storage: 10 to 90% RH, non-condensing

Safety	United States	FCC Part 15J Class B UL1950 Rev. 3
	Canada	DOC SOR/88-475 CSA C22.2 No. 950 Rev. 3
CE Marking		Directive 89/336/EEC EN 55022 Class B EN 50082-1
		Directive 73/23/EEC EN 60950

Supported Monitor Displays The following table lists the display formats supported by the projector:

Mode	Resolution	Frequency H(KHz)/V(Hz)	Dot (MHz)
VGACGA VGAEGA	640 x 400 640 x 350	31.46 / 70 31.46 / 70	25.175 25.175
NEC400	640 x 400	24.83 / 56.65	21.053
VGA60 VGA72 VGA75 VGA85	640 x 480 640 x 480 640 x 480 640 x 480	31.469 / 59.94 37.861 / 72.809 37.5 / 75 48.269 / 85.008	25.175 31.5 31.5 36
SVGA56 SVGA60 SVGA72 SVGA75 SVGA85	800 x 600 800 x 600 800 x 600 800 x 600 800 x 600	35.156 / 56.25 37.879 / 60.317 48.077 / 72.188 46.875 / 75 53.674 / 85.061	36 40 50 49.5 56.25
XGA43i XGA60 XGA70 XGA75 XGA85	1024 x 768 1024 x 768 1024 x 768 1024 x 768 1024 x 768	35.522 / 86.958 48.363 / 60.004 56.476 / 70.069 60.023 / 75.029 68.677 / 84.997	44.9 65 75 78.75 94.5
SXGA1_70 SXGA1_75 SXGA1_85	1152 x 864 1152 x 864 1152 x 864	63.851 / 70.012 67.5 / 75 77.094 / 84.999	94.5 108 121.5
SXGA2_60 SXGA2_75 SXGA2_85	1280 x 960 1280 x 960 1280 x 960	60 / 60 75 / 75 85.938 / 85.002	108 126 148.5

Mode	Resolution	Frequency H(KHz)/V(Hz)	Dot (MHz)
SXGA3_43i SXGA3_60 SXGA3_75 SXGA_85	1280 x 1024 1280 x 1024 1280 x 1024 1280 x 1024	46.433 / 86.871 63.981 / 60.02 79.976 / 75.025 91.146 / 85.024	78.75 108 135 157.5
UXGA48i UXGA60 (these are not supported by PowerLite 500c)	1600 x 1200 1600 x 1200	62.5 / 96.08 75 / 60	135 162
MACLC13 MACII13 MAC16 MAC19-60 MAC19 MAC21	640 x 480 640 x 480 832 x 624 1024 x 768 1024 x 768 1152 x 870	34.975 / 66.62 35 / 66.67 49.725 / 74.55 48.193 / 59.28 60.241 / 74.93 68.682 / 75.062	31.33 30.24 57.28 64 80 100
NTSC (SXGA) NTSC (XGA)	1366 x 438 1024 x 438	15.734 / 60	28.486 20.890
PAL (SXGA) PAL (XGA)	1366 x 512 1024 x 512	15.625 / 50	28.846 21.154
SECAM (SXGA) SECAM (XGA)	1366 x 512 1024 x 512	15.625 / 50	28.846 21.154

Note: The frequencies of some computers may not allow the image to be displayed correctly.

Computer Connector Pin Assignments

The Computer port is a female video RGB, 15-pin micro-D-style connector. Here are the pin assignments:

Input pin	Computer connector signals
1	Red video
2	Green video
3	Blue video
4	GND
5	GND
6	Red video GND
7	Green video GND
8	Blue video GND
9	Reserve
10	Synchronous GND
11	GND
12	SDA
13	Horizontal sync/composite sync
14	Vertical sync
15	SCL

Index

A

- A/V Mute Button, 29
- About menu, 31 to 32
- Advanced menu, 30
- Audio
 - connecting desktop, 9, 13
 - menu, 23

B

- Brightness, 33
- Brightness setting, 20, 22
- Buttons, remote control, 18 to 19

C

- Camcorder, adjusting the projected image, 22
- CE Marking, 35
- Ceiling, hanging the projector from, 30
- Color setting, 21, 22
- Color Temp setting, 30
- Computer connector pin assignments, 37
- Computer, adjusting projected image for, 20
- Connecting projector
 - to a desktop Macintosh, 10 to 14
 - to a desktop PC, 7 to 9
- Contrast setting, 20, 22

D

- DIP switches, 12
- Display formats, supported, 35 to 36
- Distance from projector to screen, 5 to 6
- Drawing tools, 24

E

- Effect menu, 24
- Electrical specifications, 34
- Environmental specifications, 34 to 35

F

- Formats, supported display, 35 to 36

G

- Gamma setting, 21, 22

H

- Humidity requirements, 34

I

- Image
 - adjusting position, 20, 22
 - adjusting quality, 20 to 22
 - size range, 6, 33
- Image signal mode, 22

K

- Keystone setting, 25

L

- Lamp specifications, 34
- Language setting, 30
- Lumens, 33

M

Macintosh, connecting projector to, 10 to 14

Mechanical specifications, 34

Menus

- About, 31 to 32

- Advanced, 30

- Audio, 23

- changing settings, 18 to 19

- Effect, 24

- Reset All, 32

- Setting, 25

- User's Logo, 26

- Video, 20 to 22

Monitors, supported, 35 to 36

P

Picture-in-picture option, 25

Pin assignments, connector, 37

Positioning the projector, 5 to 6

Positioning the screen image, 20, 22

Power

- consumption, 34

- management, 25

- supply, 34

Projector

- distance to screen, 6

- hanging from the ceiling, 30

- lamp specifications, 34

- positioning, 5 to 6

- positioning the screen image, 20, 22

- setting up, 5

- turning off, 16

- turning on, 14

R

Rear projection, 30

Remote control

- buttons, 18 to 19

- specifications, 34

Reset All feature, 32

Resolution, 33

S

Setting menu, 25

Sharpness setting, 21, 22

Speakers, adjusting sound, 23

Specifications

- electrical, 34

- environmental, 34 to 35

- general, 33

- lamp, 34

- mechanical, 34

- remote control, 34

- safety, 35

Startup screen, 30

Sync setting, 20

T

Temperature requirements, 34

Tint setting, 22

Tone setting, 23

Tracking setting, 20

Turning off the projector, 16

Turning on additional equipment, 16

Turning on the projector, 14

U

User's Logo feature, 26

V

VCR, adjusting the projected image, 22

Video

- adjusting the projected image, 22

- menus, 20 to 22

Volume setting, 23

Z

Zoom ratio, 33