

EPSON

PP-100Ⅲ
PP-50Ⅱ
PP-100AP

User's Guide

for Mac

Disc producer™

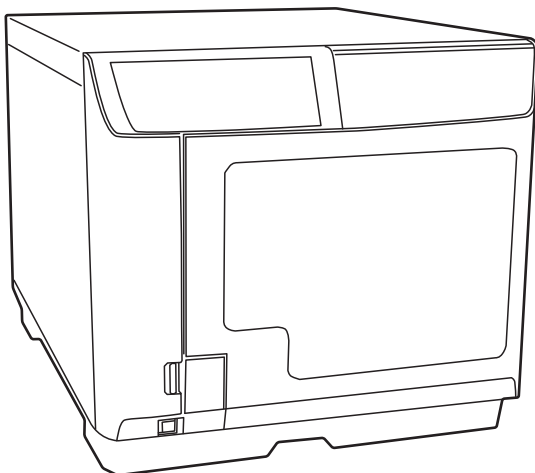

All rights reserved. No part of this publication may be reproduced, stored in a retrieval system, or transmitted in any form or by any means, electronic, mechanical, photocopying, recording, or otherwise, without the prior written permission of Seiko Epson Corporation. No patent liability is assumed with respect to the use of the information contained herein. While every precaution has been taken in the preparation of this manual, Seiko Epson Corporation assumes no responsibility for errors or omissions. Neither is any liability assumed for damages resulting from the use of the information contained herein.

Neither Seiko Epson Corporation nor its affiliates shall be liable to the purchaser of this product or third parties for damages, losses, costs, or expenses incurred by purchaser or third parties as a result of: accident, misuse, or abuse of this product or unauthorized modifications, repairs, or alterations to this product, or (excluding the U.S.) failure to strictly comply with Seiko Epson Corporation's operating and maintenance instructions.

Seiko Epson Corporation shall not be liable against any damages or problems arising from the use of any options or any consumable products other than those designated as Original Epson Products or Epson Approved Products by Seiko Epson Corporation.

NOTICE: The contents of this manual are subject to change without notice.

©Seiko Epson Corporation 2019–2026

Trademarks

- Apple, Mac, and macOS are registered trademarks of Apple Inc. in the United States and/or other countries.
- Intel is a registered trademark of Intel Corporation.
- Adobe and Illustrator are either registered trademarks or trademarks of Adobe in the United States and/or other countries.
- QR Code is a registered trademark of DENSO WAVE INCORPORATED in Japan and other countries.

All other trademarks are the property of their respective owners and used for identification purpose only.

Marks Used in this Guide

The following marks are used in this guide to indicate important information.



Indicates information with which you must comply when using this product. Ignoring this information and mishandling the product may cause it to fail or malfunction.

Notes

Indicates an additional explanation or information we want you to know.

Screens and Illustrations in this Guide

Depending on your model and environment, the screen shots used in this guide may differ from the actual screens displayed. However, you can still use the same procedures described in this guide. Unless otherwise indicated, the illustrations used in this guide are those for the PP-100III.

Organization of this Manual

The following instruction guides are included with this product.

For Windows OS

Setup Guide	Briefly describes how to set up this product with illustrations. See <i>User's Guide</i> for more information.
User's Guide (PDF)	Presents detailed information users need to know such as the product/software functions and operations, how to troubleshoot various problems, as well as maintenance information. It can be downloaded from the Epson website. You can also display it from the start menu after installing the software.

For macOS

Setup Guide for Mac	Briefly describes how to set up this product with illustrations. See <i>User's Guide for Mac</i> for more information.
User's Guide for Mac (This manual)	Presents detailed information users need to know such as the product/software functions and operations, how to troubleshoot various problems, as well as maintenance information. Download the software from the website. Double-click the file that was downloaded. You can access it by clicking Launchpad , EPSON Software , and then EPSON Total Disc Maker after installing the software.

Table of Contents

Trademarks.....	2
Marks Used in this Guide.....	2
Screens and Illustrations in this Guide.....	2
Organization of this Manual.....	3

Before Using this Product 7

■ For Safe Use.....	7
Cautions for the Power Source.....	9
Cautions for Using.....	10
■ Cautions for CD/DVD discs.....	12
■ Uses of this Product.....	12
■ Incidental Loss Arising from the Use of this Product.....	12
■ Restriction of Use.....	12

Basic Operations 13

■ Parts Names.....	13
■ Lights for the Status of the Product.....	18
■ Turning Power On/Off.....	20
Turning On the Power.....	20
Turning Off the Power.....	20
■ Opening/Closing the Disc Cover.....	21
Opening the Disc Cover.....	21
Closing the Disc Cover.....	22
■ Handling Stackers.....	23
Stacker 1/Stacker 2.....	23
Stacker 3.....	24
Stacker 4 (Only for PP-100III/PP-100AP).....	25

Software Settings..... 26

■ Installing Software.....	26
System Requirements.....	27
■ Properties Setting.....	28
■ Common Settings for Publishing.....	30
Setting a Working Folder.....	30

Notification Settings (Only for PP-100AP).....	31
Write Settings (Only for PP-100III/PP-50II).....	32

■ Uninstalling the Software.....	33
----------------------------------	----

Using Software 35

■ EPSON Total Disc Maker.....	35
What is EPSON Total Disc Maker?.....	35
Starting EPSON Total Disc Maker.....	35
EPSON Total Disc Maker Help.....	35
Screen Configuration of EPSON Total Disc Maker.....	36
■ EPSON Total Disc Utility.....	39
What is EPSON Total Disc Utility?.....	39
Starting EPSON Total Disc Utility.....	39
EPSON Total Disc Utility Help.....	39
Screen Configuration of EPSON Total Disc Utility.....	40
■ Printer Driver.....	45
What is the Printer Driver?.....	45
Displaying the Printer Driver Screen.....	45
Screen Configuration of Printer Driver.....	46

Publishing Discs 49

■ Compatible Disc Types.....	49
Printable Disc Types.....	49
Writable Disc Types.....	50
■ Handling Discs.....	51
Notes on Usage.....	51
Notes on storage.....	52
■ Printable Area.....	53
Setting the Print Area.....	54
■ Flow for Publishing Discs.....	55
Selecting Publish Mode.....	57
Loading Discs.....	61
Registering Write Data (Only for PP-100III/PP-50II).....	63
Creating Labels.....	65
Publishing Discs.....	66
Setting Printer Driver and Publishing Discs.....	68

Taking out discs	71
■ Job Operations	73
Pausing/Cancelling Jobs	73
Priority Publishing	74

Convenient Features 75

■ Printing on User Defined Label Size Discs .	75
■ Creating Disc Copies (Only for PP-100III/PP-50II)	76
Creating Copies Directly from Discs	76
Creating Copies from Disc Image Files	78
■ Adjusting Print Colors	79

Maintenance 81

■ Replacing the Ink Cartridge	81
Checking the Ink Levels	81
How to Replace the Ink Cartridges	82
■ Checking the Print Head Nozzles.....	85
How to Perform a Nozzle Check	85
■ Cleaning the Print Head	87
How to Clean the Print Head.....	88
■ Aligning the Print Head.....	90
■ Correcting the Printing Position	93
■ Cleaning Your Product.....	96
Cleaning the Exterior	96
Cleaning the Interior.....	96
Cleaning the Air Vents (Only for PP-100III/PP-50II)	97
■ Checking Maintenance Information.....	100
■ Replacing the Ink Pad (Only for PP-50II)	102
How to Check When it is Time to Replace the Ink Pad	102
How to Replace the Ink Pad.....	102
■ Replacing the Maintenance Box (Only for PP-100III/PP-100AP)	103
How to Check When it is Time to Replace the Maintenance Box	103
How to Replace the Maintenance Box.....	103

■ Replacing the Drive (Only for PP-100III) .	105
How to Check When it is Time to Replace the Drive	105
How to Replace the Drive	105
■ Precautions for Transporting Your Product	106

Troubleshooting..... 108

■ Problems and their Remedies.....	108
Power/Control Panel Problems.....	108
Disc Transferring (Input/Output) Problems	109
Disc Writing Problems (Only for PP-100III/PP-50II)	110
Label Printing Problems.....	111
Other Problems	113
■ Checking Lights for Errors	115
Error Associated with Covers.....	115
Error Associated with Disc Transfer.....	116
Error Associated with Stacker	118
Error Associated with Ink.....	119
Error Associated with Printer.....	120
Error Associated with Drives (Only for PP-100III/PP-50II)	121
Other Error	122
■ Checking with EPSON Total Disc Utility ..	123
■ When Discs Cannot be Published	125
■ Disc Does not Come Out.....	129
Drive Tray Does not Come Out (Only for PP-100III/PP-50II)	129
Printer Tray Does not Come Out.....	130
■ Disc Recording Surface is Stained with Ink	137

Appendix 144

■ Where to get help	144
Before Contacting Epson	144
Help for Users in the United States and Canada	144
Help for Users in the Europe (EMEA)	144
Help for Users in Australia	145
Help for Users in Southeast Asia.....	145



■ Product Specifications.....	147
Basic Specifications	147
■ Consumables and Options	154
Ink cartridges and Maintenance Box	154
Discs	154
Drive (Only for PP-100III)	154







Before Using this Product

For Safe Use

- To use this product safely, be sure to read this guide as well as the other instruction guides included with this product before using it.
- Keep this guide at hand so that you can resolve any questions you have about this product.

To prevent harm to customers and other people or damage to property, this guide contains the following symbols and warning displays for operations and use that may be dangerous. Please thoroughly understand this information before you read this guide.





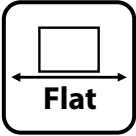
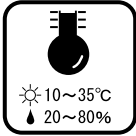

 WARNING	If this display is ignored and the product is mishandled, it may result in death or serious injury.
 CAUTION	If this display is ignored and the product is mishandled, it may result in bodily harm or physical damage.

	Indicates action that should not be performed (prohibited).		Indicates items (instruction, action) that must be performed.
	Indicates that disassembly is prohibited.		Indicates that the plug should be disconnected from the outlet.
	Indicates that touching the product with wet hands is prohibited.		Indicates that the product must be used with the power cord grounded.
	Indicates that the product must not come in contact with water.		













Install this product in the following type of place.

Place that is flat and stable	Place with the following temperature and humidity range
	 <p>☀ 10~35°C 💧 20~80%</p>











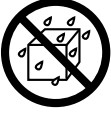

<ul style="list-style-type: none"> • When using this product in a place where static electricity is easily generated, use an antistatic mat or other product to prevent static electricity. • Do not install on a surface that is smaller than the base of the product. If the rubber bases on the bottom of the product extend beyond this surface, it places stress on the internal mechanisms, which negatively affects disc writing, printing and transporting. Be sure to install on a flat surface that is wider than the product so that all of the feet on the base of the product rest firmly on it. 	
---	---





 <p>WARNING</p>	<p>Do not block the air vents on this product. Blocking the air vents may result in internal heat build-up and fire. Do not install in the following types of places.</p> <ul style="list-style-type: none"> • Tight spaces where ventilation is poor, such as in a closet or on a bookshelf • On a rug or bed <p>If you place the product by a wall, leave more than 10 cm between the back of the product and the wall. It is also necessary to leave enough space in front of the product to open and close the disc cover.</p>	
	<p>Do not install in a place where volatile substances, such as alcohol or paint thinner, are present or in a place where there is fire. This may result in electric shock or fire.</p>	
 <p>CAUTION</p>	<p>Do not install or store in an unstable place (such as on a wobbly or tilted surface), in reach of children, or in a place subject to vibration from other machines. There is a risk that it could drop or fall over, resulting in injury.</p>	
	<p>Do not install in places where there is excessive moisture or dust, risk of getting wet, direct sunlight, severe changes in temperature and humidity, or close to heating and cooling devices. There is a risk of electric shock, fire, and malfunction or failure of this product.</p>	

Cautions for the Power Source

 WARNING	<p>Do not connect or disconnect the power plug with wet hands. This may result in electric shock.</p> 
	<p>Use only the type of power source indicated on the product's label. Use of the wrong type of power source may result in electric shock or fire.</p> 
	<p>Do not plug the power cord into an outlet with many other cords connected to it. This may result in heat build-up and fire.</p> 
	<p>Do not use a damaged power cord. This may result in electric shock or fire. If the power cord is damaged, consult your dealer for repairs. Observe the following when handling the power cord.</p> <ul style="list-style-type: none"> • Do not modify the power cord • Do not place heavy objects on the power cord • Do not bend, twist or pull the power cord by force • Do not wire heating appliances nearby 
	<p>Be careful when handling the power plug. Mishandling may result in fire.</p> <ul style="list-style-type: none"> • Do not leave plugged into a power source having foreign matter such as dust • Firmly insert the prongs of the power plug all the way 
	<p>When you disconnect the power plug from the outlet, be sure to turn off the power and hold the plug as you pull. If you stretch the power cord, it may become damaged, which could result in electric shock or fire.</p> 
	<p>Be sure your AC power cord meets the relevant local safety standard. Also, do not use the power cord included with this product with any other devices. This may result in electric shock or fire.</p> 
	<p>For safety reasons, be sure to ground the power cord. The power code included with the product is a 3-pin cable with a power system grounding (PE) terminal, so connect it to an outlet with a grounding electrode and ground it securely.</p> 
<p>Regularly disconnect the power plug from the outlet and clean the base of the prongs and between the prongs. If you leave the power plug connected to an outlet for a long time, the base of the power plug prongs may become dusty, which may result in short circuit and fire.</p> 	
 CAUTION	<p>For safety, be sure to disconnect the power plug from the outlet when you will not be using the product for a long time.</p> 

Cautions for Using

 WARNING	<p>Do not continue to use under abnormal conditions such as smoke, unusual odors or sounds.</p> <p>This may result in electric shock or fire. Immediately turn off the power, disconnect the power plug from the outlet, and contact your dealer or the Epson Repair Center about repairs. Servicing the product yourself is dangerous, so never attempt it.</p>	
	<p>If a foreign object, water or other liquid enters the product, do not continue to use it.</p> <p>This may result in electric shock or fire. Immediately turn off the power, disconnect the power plug from the outlet, and contact your dealer or the Epson Repair Center about repairs.</p>	
	<p>Do not attempt to service the product yourself.</p> <p>This may result in injury, electric shock, fire or malfunction.</p>	
	<p>Do not use flammable gas sprays inside or around this product.</p> <p>There is a risk that gas will build up and a spark may cause a fire.</p>	
	<p>Do not connect the cables (cords) to the product in a way other than that specified in the instruction guide.</p> <p>This may result in fire. Also, the connected devices may be damaged.</p>	
	<p>Do not insert or drop metal or flammable objects into the air vents or other openings.</p> <p>This may result in electric shock or fire.</p>	
 CAUTION	<p>Do not step or place heavy objects on top of the product.</p> <p>Be especially careful in households with small children. There is a risk that it could fall over or break, resulting in injury.</p>	
	<p>When connecting this product to a computer (or other devices) using a cable, be careful to orient the connector the right way.</p> <p>The connectors on the cables have a specific orientation. If you connect incorrectly oriented connectors to both this product and the computer (or other devices), this may result in the malfunction of both connected devices.</p>	
	<p>When storing or transporting this product, do not tilt it, stand it on end, or turn it upside down.</p> <p>When transporting the product, be sure to package it in the original box to protect it from any impact.</p>	
	<p>For safety reasons, if you move this product, first check that the power is off, the power plug is disconnected from the outlet, and all of the wires are disconnected.</p>	

 CAUTION	When replacing the ink cartridges, be careful that the ink does not contact your eyes or skin. If ink gets into your eyes, immediately flush them with water, and if it gets onto your skin, immediately wash the area with soap and water. Otherwise you may have bloodshot eyes or a mild inflammation. In the rare event that there is a problem, immediately consult a physician.	
	Do not disassemble the ink cartridges to replenish or refill the ink.	
	Do not shake the ink cartridge too hard. The ink cartridge may leak if you shake it too much.	
	Store ink cartridges out of the reach of children. Also, do not ingest the ink.	

Cautions for CD/DVD discs

Before using this product, run an operation check to make sure it is functioning normally. Also, back up the data on CD/DVD discs onto separate media as necessary. Data may be damaged or lost at the following times:

- When there is static electricity or electrical noise
- During improper use
- During a malfunction or repair
- When there is damage due to a natural disaster

Even if the product is still under warranty, Epson accepts no responsibility for data that is lost or damaged due to causes not limited to those listed above.

Uses of this Product

This product is for business use and not for household use.

Incidental Loss Arising from the Use of this Product

Should you not obtain the results you expect from this product, including the bundled software, we cannot provide compensation for incidental loss arising from that fact, such as expenses required for the use of this product and lost earnings that would have been gained through the use of this product.

Restriction of Use

When this product is used for applications requiring high reliability / safety, such as transportation devices related to aviation, rail, marine, automotive, etc.; disaster prevention devices; various safety devices, etc.; or functional / precision devices, etc., you should use this product only after giving consideration to including fail-safes and redundancies into your design to maintain safety and total system reliability. Because this product was not intended for use in applications requiring extremely high reliability / safety, such as aerospace equipment, main communication equipment, nuclear power control equipment, or medical equipment related to direct medical care, etc., please make your own judgment on this product's suitability after a full evaluation.

Basic Operations

Parts Names

Front

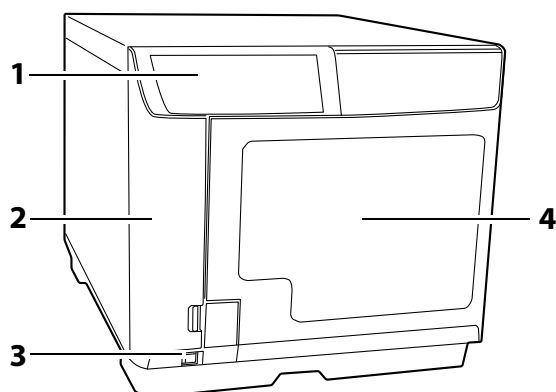

1	Control panel	Use to control the product. It also shows the status of the product. See "Control panel" on page 17 for details.
2	Ink cartridge cover	Open to insert and replace ink cartridges.
3	Power button	Use to turn the product on and off.
4	Disc cover	Open to load and take out discs.

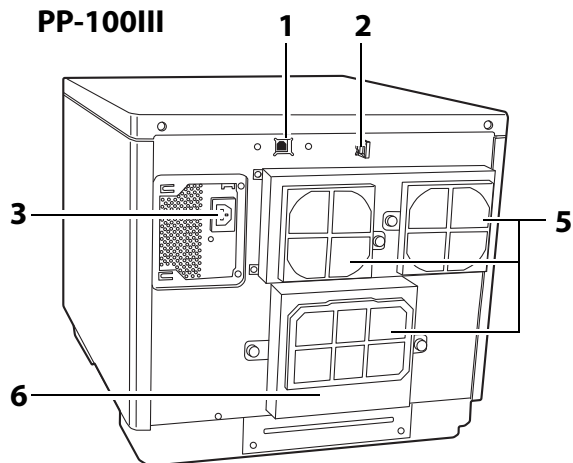
*Back***PP-100III**

1	USB interface connector
---	-------------------------

Plug the USB cable into this connector.

2	Interface cable holder
---	------------------------

Use to fix the USB cable.

3	AC inlet
---	----------

Plug the power cord into this connector.

4	Rear printer cover
---	--------------------

Open this cover only when a disc is stuck in the printer tray.

5	Air vents
---	-----------

Expel heat generated inside this product to prevent the temperature from rising. Leave at least 10 cm between the back of the product and the wall for ventilation.

6	Maintenance box cover
---	-----------------------

Open this cover to replace a maintenance box or remove a disc stuck in the printer tray.

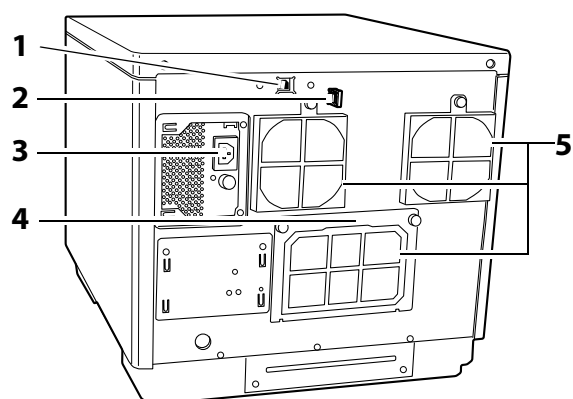
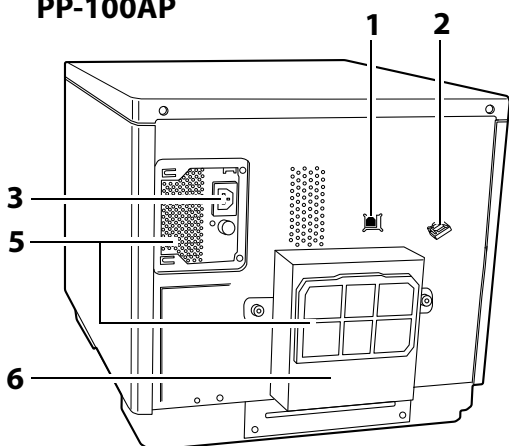
PP-50II**PP-100AP****Notes**

When connecting to the USB Type-C connector of a computer, use the genuine Apple USB-C to USB adapter.

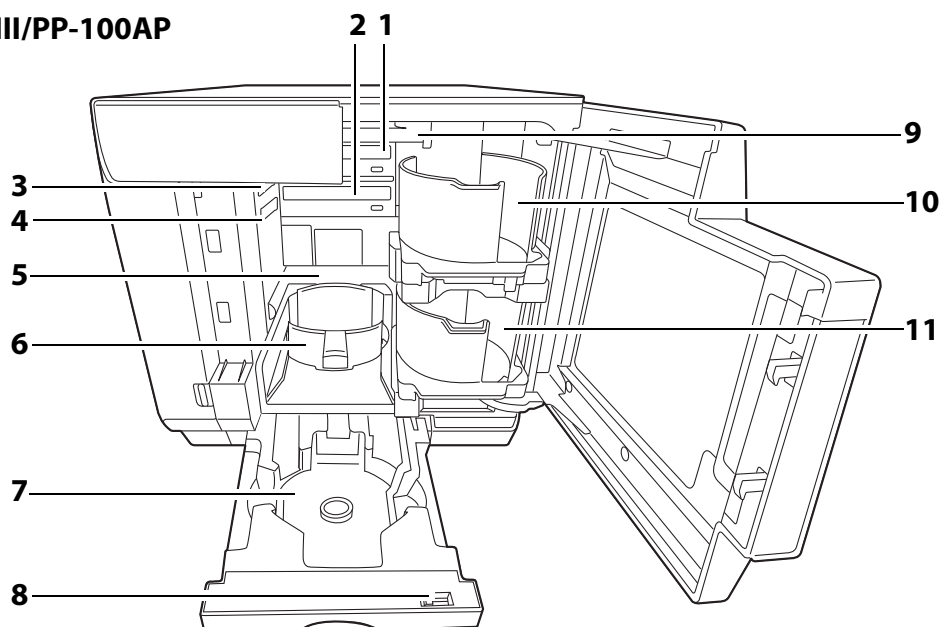
*Inside***PP-100III/PP-100AP**

1	Drive 1 (Only for PP-100III) Writes data on the recording surface of the discs.
2	Drive 2 (Only for PP-100III) Writes data on the recording surface of the discs.
3	Drive release lever 1 (Only for PP-100III) Releases Drive 1 when you replace it.
4	Drive release lever 2 (Only for PP-100III) Releases Drive 2 when you replace it.
5	Printer Prints on the label surface of the discs.
6	Stacker 3 Use as the disc output stacker. Holds up to about 50 discs.
7	Stacker 4 Use as a disc output stacker. Holds up to about 5 discs.
8	Lock lever Locks and unlocks Stacker 4. Be sure to lock when using Stacker 3.
9	Arm Transports discs.
10	Stacker 1 Use Stacker 1 as a disc input stacker. Holds up to about 50 discs.
11	Stacker 2 Use Stacker 2 as a disc input or output stacker. Holds up to about 50 discs.

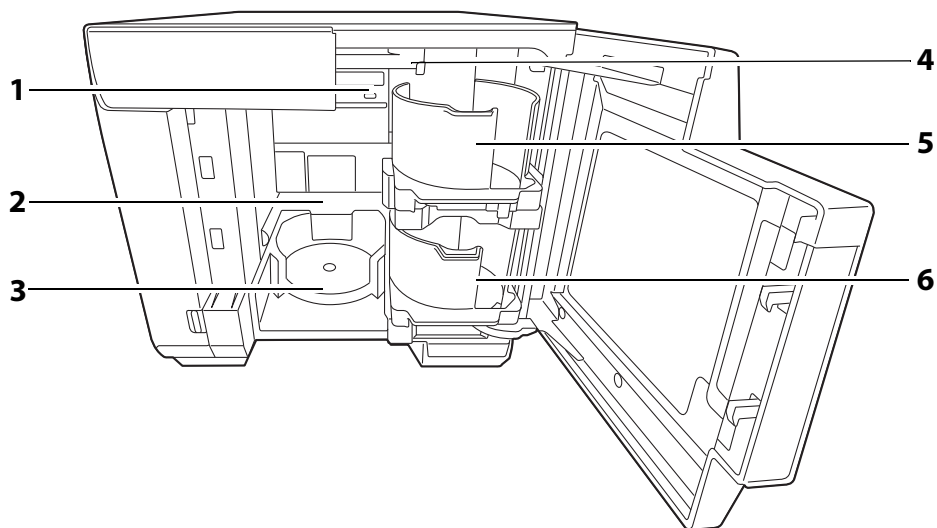
PP-50II

1	Drive
Writes data on the recording surface of the discs.	
2	Printer
Prints on the label surface of the discs.	
3	Stacker 3
Use as the disc output stacker. Holds up to about 20 discs.	
4	Arm
Transports discs.	
5	Stacker 1
Use Stacker 1 as a disc input stacker. Holds up to about 50 discs.	
6	Stacker 2
Use Stacker 2 as a disc input or output stacker. Holds up to about 50 discs.	

Control panel

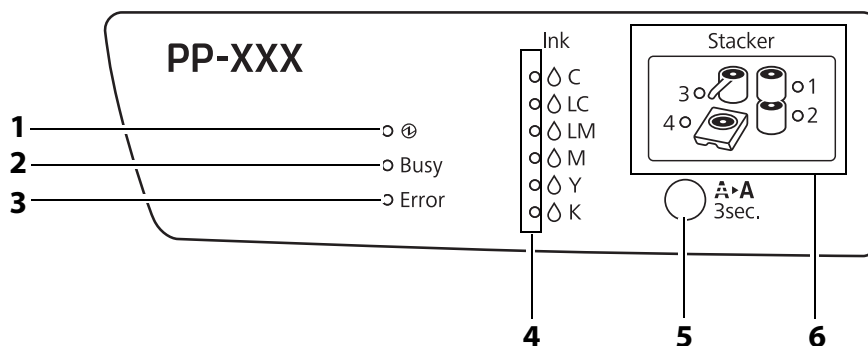

1	Power light	Flashes or turns on when the power is turned on.
2	BUSY light	Flashes when a job* is being processed.
3	ERROR light	Flashes or turns on when an error occurs.
4	INK light	PP-100III/PP-100AP: Flashes or turns on depending on the ink/maintenance box status. PP-50II: Flashes or turns on depending on the ink status.
5	Cleaning button	Cleans the print head.
6	STACKER light	Flashes or turns on depending on the stacker status.







*Job: Processing performed by this product, such as writing and printing data

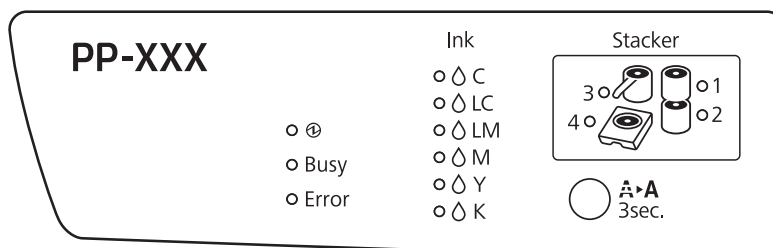

Lights for the Status of the Product

This section describes the status of the product using the lights displayed on the control panel.

The status of the product is also indicated by the combination of lights flashing/turning on. See “[Checking Lights for Errors](#)” on page 115 for details.



	Indicator light	Flashing/On	Status
①	Power light	On 	The power is on. When only the Power light is on, the product is on standby for data.
		Flashing 	Product is being initialized. When it flashes rapidly, it is shutting down
BUSY	BUSY light	Flashing 	Product is processing a job. For the PP-100III or PP-100AP, when the BUSY light is flashing rapidly, a disc is being ejected, so do not pull out Stacker 4. Discs may be damaged.
ERROR	ERROR light	On 	The cover, disc transport system, stacker, drive, or printer is experiencing an error.
		Flashing 	The unit is experiencing a problem.
INK	INK light	On 	The ink cartridge has reached its replacement time, the ink cartridge is not correctly installed, or incorrect ink cartridge is installed. For information on replacing ink cartridges, see “ Replacing the Ink Cartridge ” on page 81.
		Flashing 	The ink is low. Obtain a replacement ink cartridge. For the PP-100III or PP-100AP, when all INK lights flash rapidly, the maintenance box has reached its replacement time or is not correctly inserted. For information on replacing maintenance box, see “ Replacing the Maintenance Box (Only for PP-100III/PP-100AP) ” on page 103.

	Indicator light	Flashing/On	Status
STACKER 1/2/3/4*	STACKER light	On 	The stacker is overloaded or full.
		Flashing 	The stacker is empty or not correctly inserted.

* PP-50II does not have the **STACKER 4** light.

Notes The **STACKER** light flashes when the input stacker is empty; however, the beginning of the light flashing may not match the exact time that the stacker becomes empty.

Turning Power On/Off

This section describes how to turn the power on and off.

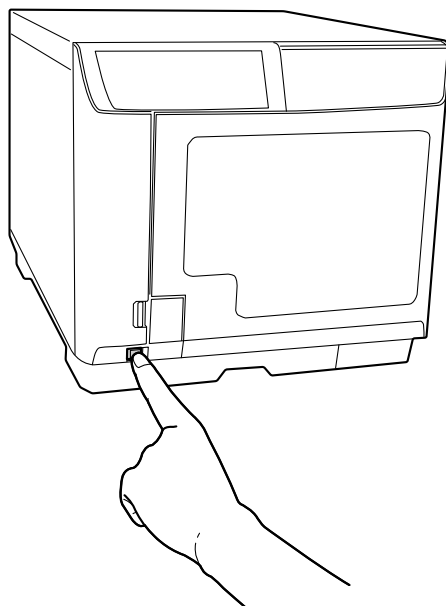

Turning On the Power

- 1 Connect the power cord.
- 2 Press the power button.
The Power light flashes green, then stays on.

Turning Off the Power

Press the power button until the Power light flashes.

The Power light flashes in green then goes off; then the power is turned off.



- The fan may continue to operate after the power is turned off, but it will automatically stop after 15 minutes.
- The product may not be recognized by the PC when the power is turned back on while fan is operating. In this case, disconnect the USB cable and connect it again.
- If the product is operating, wait for 10 seconds after operation is stopped; then turn off the power.

Opening/Closing the Disc Cover

When you load discs into the input stackers or take out discs from the output stackers, open and close the disc cover as described below.

Opening the Disc Cover

Hold the handle, and open the disc cover in the direction indicated by the arrow in the illustration below.

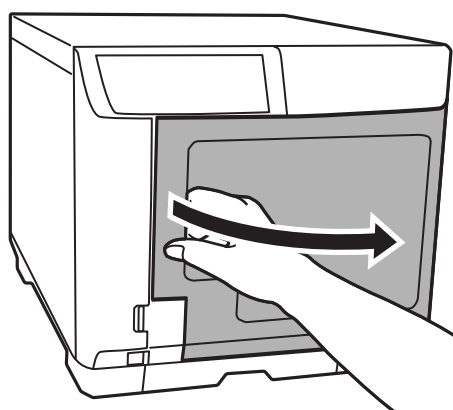

- Do not open the disc cover while a job is being processed (while the **BUSY** light is flashing). This could adversely affect the writing or printing quality.
- If a job is being processed (while the **BUSY** light is flashing) and you need to open the disc cover to load or take out discs, first pause the job and then open the disc cover. See [“Pausing/Cancelling Jobs” on page 73](#) for the procedure to pause a job.
- If you open the disc cover while a job is being processed (while the **BUSY** light is flashing), an alarm beep sounds and the current job enters the standby status. Closing the disc cover automatically resumes the job.
- While an alarm beep is sounding, the arm is moving. To ensure safety, do not put your hands inside the product. Also, do not operate any stackers while an alarm beep is sounding. This could damage the arm.

Closing the Disc Cover

Hold the handle, and close the disc cover in the direction indicated by the arrow in the illustration below.

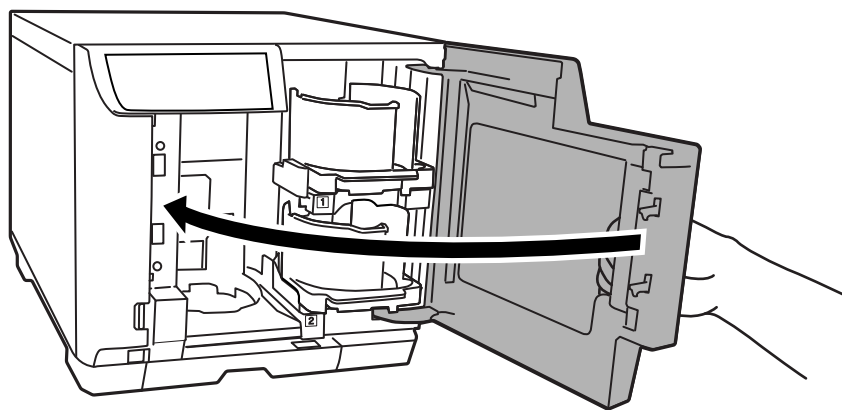
**For PP-50II**

Before closing the disc cover, make sure that there are no discs left near Stacker 3 and that discs in Stacker 3 are not slanted. Otherwise, an error may occur when you close the disc cover.

Handling Stackers

Handle the stackers as shown below.

Stacker 1/Stacker 2

Stacker 1 and Stacker 2 are the same. Handle them in the same way.

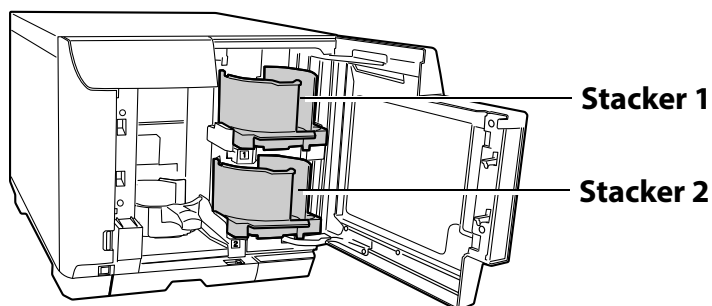

Attach

Line up the indentations and attach.

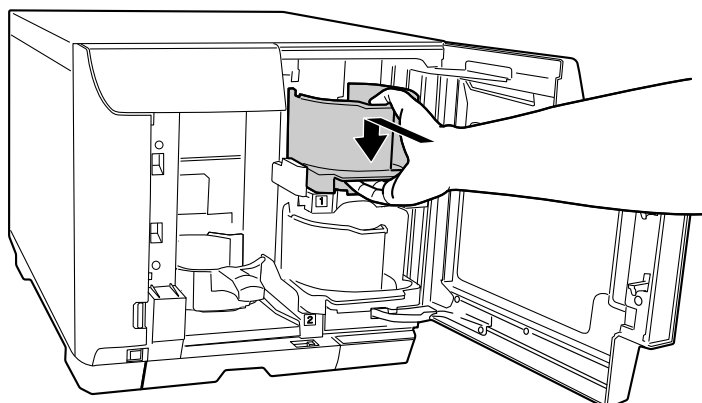

Remove

Gently lift and pull towards you to take out.

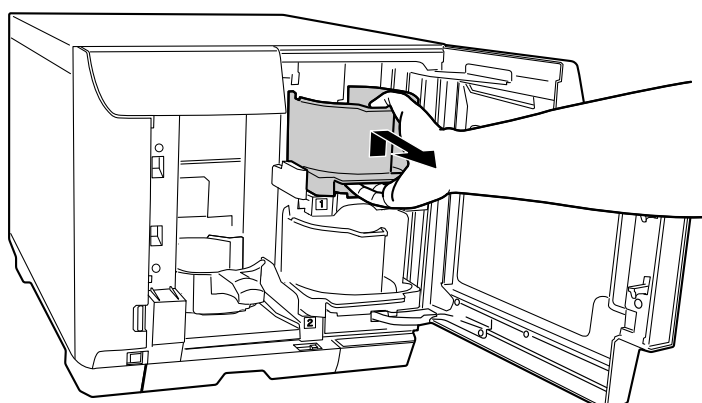

Stacker 3



For PP-50II

Stacker 3 is fixed. Its shape differs from that of stacker 3 for the PP-100III and PP-100AP.

Attach (Only for PP-100III/PP-100AP)



- When you insert Stacker 3, first check that there are no discs in Stacker 4, and then attach it.
- When you use Stacker 3, set the lock lever to **LOCK**, and do not pull out Stacker 4.

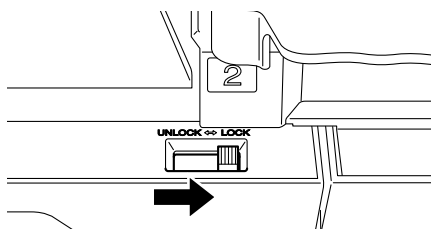

Hold the handle, line up the indentations, and attach.

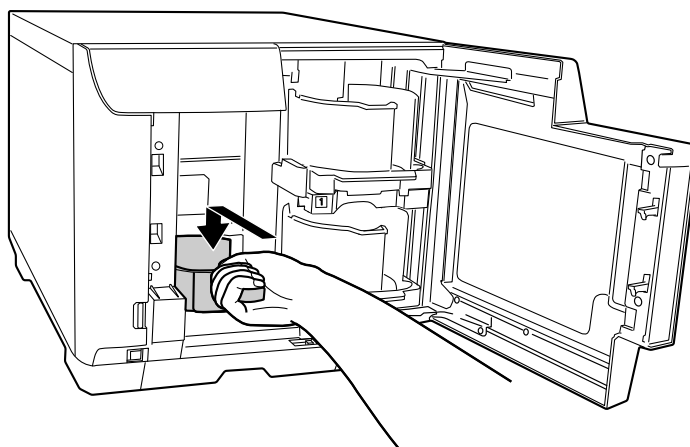

Remove (Only for PP-100III/PP-100AP)

Hold the handle, lift it up, and then pull towards you to take out.

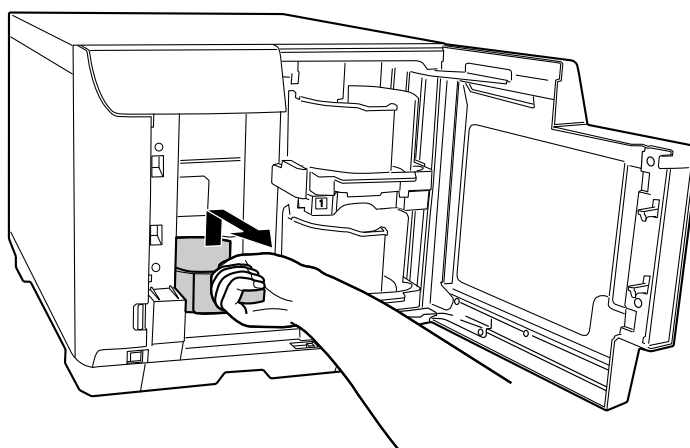

Stacker 4 (Only for PP-100III/PP-100AP)



- Do not apply strong force to Stacker 4 when handling it.
- When the **BUSY** light and the **STACKER 4** light are flashing rapidly, a disc is being ejected, so do not pull out Stacker 4. Discs may be damaged.
- When you use Stacker 4, set the lock lever to **UNLOCK**.

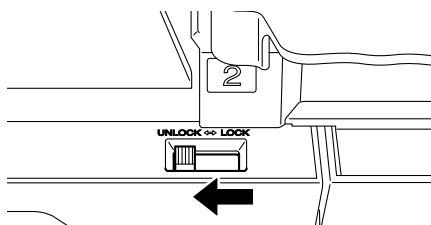

Pull out

Hold the Stacker 4 grip and pull out the stacker.

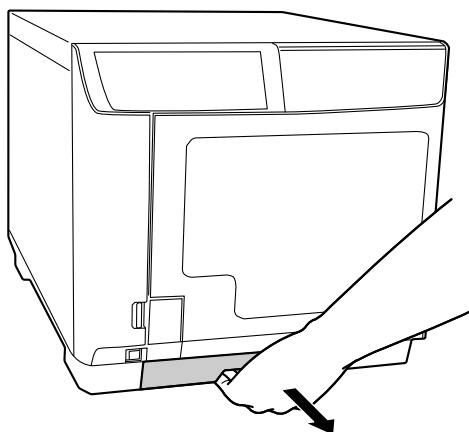

Push in

Hold the Stacker 4 grip and push the stacker in.

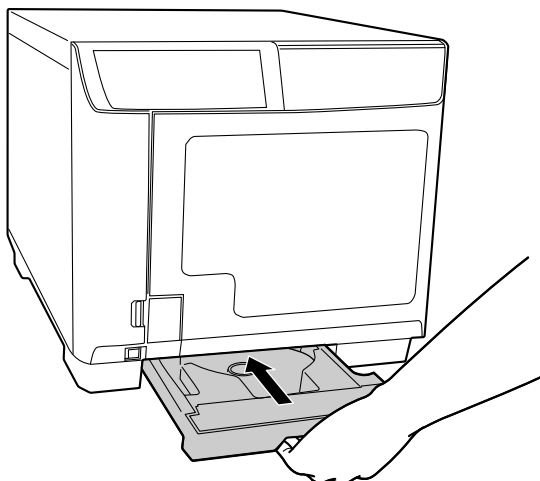

Software Settings

This section describes the basic settings of the software required for using the product (PP-100III/PP-50II/PP-100AP) after the setup. (For the setup procedure, see *Setup Guide for Mac*.)

Installing Software

The installation procedure installs the following software on your PC. (For the installation procedure, see *Setup Guide for Mac*.)

- EPSON Total Disc Utility

This software is used to set up the product and check the product status from your PC.

- EPSON Total Disc Maker

This software is used to edit the write data* and the print data for the label surface and to publish using this product.

- Printer driver

* Editing write data is not available with the PP-100AP.



- **Important Note**

You may use the software to operate the EPSON products. You may use the EPSON products to copy materials onto media, including but not limited to CDs and DVDs. You agree to respect the rights of copyright owners. EPSON shall have no liability for, and you shall hold EPSON harmless from, any copyright infringement by you or your employees, representatives or agents.

- Be sure to install the software by following the procedure in *Setup Guide for Mac*.
- The product cannot be used as a shared printer using the Mac sharing setting.
- The product cannot be used by more than one user using the Mac fast user switching.
- The operation of the product using Apple Remote Desktop is not guaranteed.

System Requirements

The minimum hardware and system requirements for using the supplied software are shown below.

OS (Operating system)	<ul style="list-style-type: none"> • macOS Sequoia Intel, Apple silicon • macOS Sonoma Intel, Apple silicon • macOS Ventura intel, Apple silicon • macOS Monterey intel, Apple silicon • macOS Big Sur intel, Apple silicon • macOS Catalina • macOS Mojave • macOS High Sierra • macOS Sierra • Mac OS X El Capitan • Mac OS X Yosemite • Mac OS X Mavericks
CPU	<ul style="list-style-type: none"> • Apple silicon • Intel 64 bit CPU
Memory	Must meet OS requirements.
Storage available space	<p>In addition to the OS system requirements, ensure the following available space.</p> <ul style="list-style-type: none"> • For program installation: 1Gbyte • On the drive containing the work folder: About 1.5 times (Min.: 1Gbyte) the disc to be created.
Display	XGA (1024 x 768 pixels) or higher 65,536 colors or more
Interface	<ul style="list-style-type: none"> • For the PP-100III: USB 3.0 or USB 2.0 <ul style="list-style-type: none"> * Compatible with USB 3.0 or USB 2.0 standard * Ensure SuperSpeed USB or Hi-Speed USB performance * Intel chipset USB interfaces earlier than the Intel 5 Series are not yet supported • For the PP-50II/PP-100AP: USB 2.0 <ul style="list-style-type: none"> * Compatible with USB 2.0 standard * Ensure Hi-Speed USB performance



- The product may not function properly where third-party writing software is installed, anti-virus software is installed, or another USB device is connected.
- The source drive should use commands and operations that are compliant with MMC4 or higher, and be capable of reading sub-channels. (Only for PP-100III/PP-50II)
- Writing to Blu-ray Discs is not guaranteed for Macs.

Properties Setting

After installing the software and adding the printer (For these procedures, see *Setup Guide for Mac.*), follow the steps below to set **Stacker Settings**, **Drive Settings**, and **Printer Settings** with EPSON Total Disc Utility.

- 1 Make sure that the product is connected to the PC via the USB cable and that the product is turned on.
- 2 Start up EPSON Total Disc Utility.
See “Starting EPSON Total Disc Utility” on page 39.
- 3 Double-click the product name.

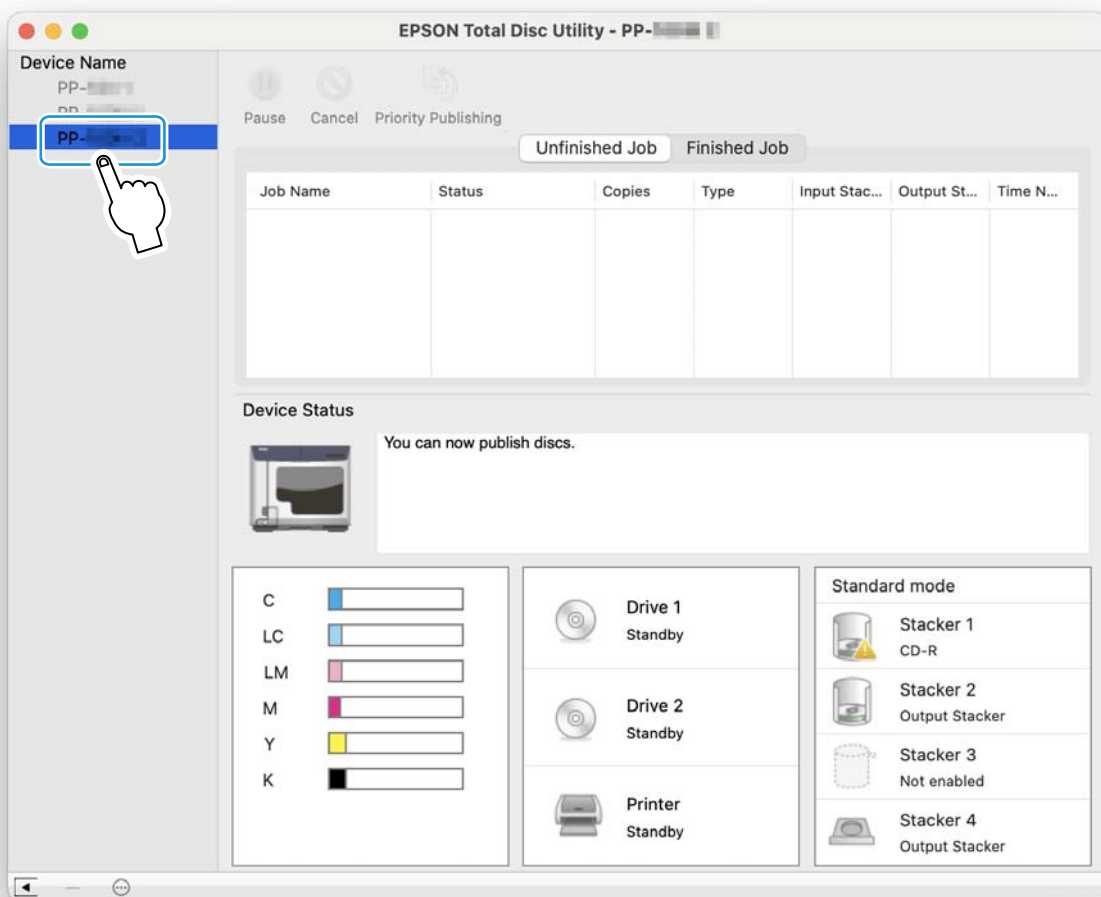

The **Properties** screen appears.

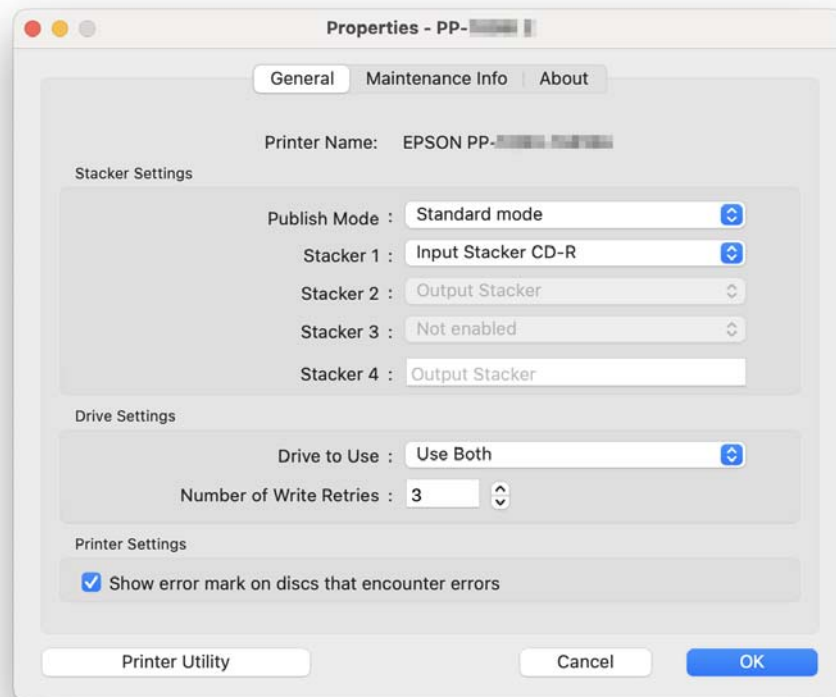

4 Set **Stacker Settings**, **Drive Settings** (only for PP-100III/PP-50II), and **Printer Settings** (only for PP-100III/PP-50II).

See EPSON Total Disc Utility Help for details.

Notes

- Setting the most suitable publish mode for the usage or number of discs to be published enables efficient disc publishing. (See [“Selecting Publish Mode” on page 57.](#))
- Setting the **Number of Write Retries** enables a job to be executed again without job processing pausing even if an error occurs during writing. The error disc is output to the output stacker.
- The error mark will not be printed in the following cases.
 - * The job was cancelled
 - * An incorrect disc type was found in the input stacker
 - * Not enough ink was left to print the error mark
 - * Fatal error
- **For PP-100III**
Error discs are ejected to:
 - * Stacker 4 in Standard mode
 - * Stacker 3 or Stacker 4 in External Output mode
 - * Stacker 2 or Stacker 3 in Batch mode
- **For PP-50II**
Error discs are ejected to Stacker 3.
- For EPSON Total Disc Utility Help, see [“EPSON Total Disc Utility Help” on page 39.](#)

5 Click **OK**.

Common Settings for Publishing

Follow the steps below to set **Working Folder**, **Notification Settings**, and **Write Settings**.



These settings are reflected for all the publishers (PP-100III/PP-50II/PP-100AP) registered.

Setting a Working Folder

Follow the steps below to create a Working Folder on the hard disk for the disc publishing operation.

- 1 Start up EPSON Total Disc Utility.
See “Starting EPSON Total Disc Utility” on page 39.
- 2 Select **Common Settings for Publishing** from the **Tools** menu.
The **Common** screen appears.

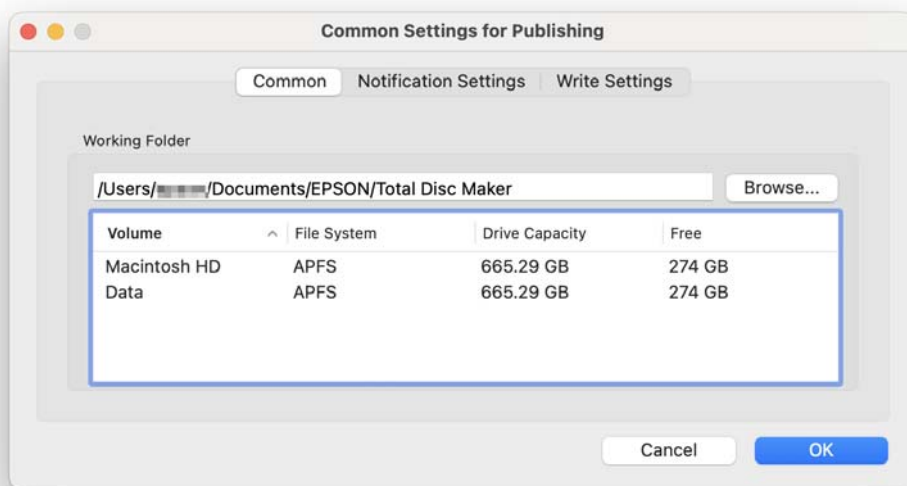

- 3 Click **Browse...** to select a folder to create a Working Folder.



Select a drive with sufficient free space (25 GB or more).

- 4 Click **OK**.

Notification Settings (Only for PP-100AP)

Follow the steps below to set the buzzer function that lets you know when jobs end with the PP-100AP.

- 1** Start up EPSON Total Disc Utility.
See [“Starting EPSON Total Disc Utility” on page 39](#).
- 2** Select **Common Settings for Publishing** from the **Tools** menu.
- 3** Click **Notification Settings**.
The **Notification Settings** screen appears.

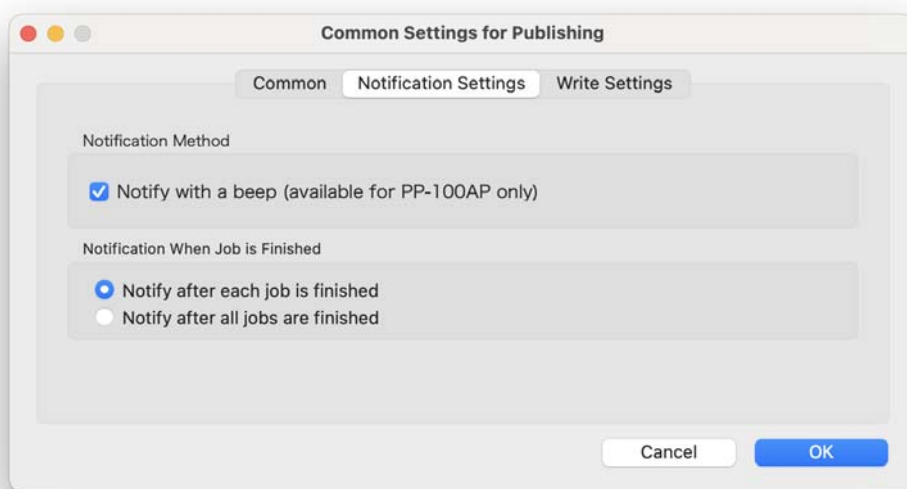

- 4** Set **Notification Method** and **Notification When Job is Finished**.
See EPSON Total Disc Utility Help for details.

Notes For EPSON Total Disc Utility Help, see [“EPSON Total Disc Utility Help” on page 39](#).

- 5** Click **OK**.

Write Settings (Only for PP-100III/PP-50II)

Follow the steps below to set **Write Speed** and **Write Verification** with the PP-100III/PP-50II.

Notes

If you publish with EPSON Total Disc Maker, changing the settings is possible also in Publish view.

- 1 Start up EPSON Total Disc Utility.
See “Starting EPSON Total Disc Utility” on page 39.
- 2 Select **Common Settings for Publishing** from the **Tools** menu.
- 3 Click **Write Settings**.
The **Write Settings** screen appears.

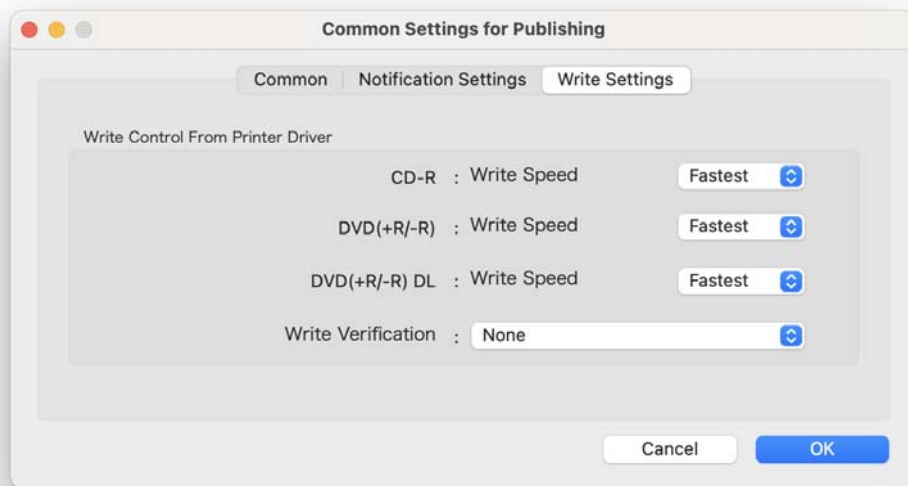

- 4 Set **Write Speed** and **Write Verification**.



- Depending on the discs and PC used, the writing speed may become slower than the set speed.
- Depending on the discs used, writing may not be able to be performed properly at the speed recommended for the disc. If this happens, write at a slower speed. In particular, we recommend writing to DVD±R DL at a slow speed.

Notes

If **Write Verification** is set to **Compare**, you can confirm whether data was written to discs properly.



- 5 Click **OK**.

Uninstalling the Software



If the software could not be installed properly, uninstall (delete) the software, and then reinstall it.

Notes

- You may be asked for an administrator password when uninstalling the software. When asked for a password, enter the password to proceed with the operation.
- Uninstalling the Epson printer driver also causes Total Disc Maker for Mac to be uninstalled.

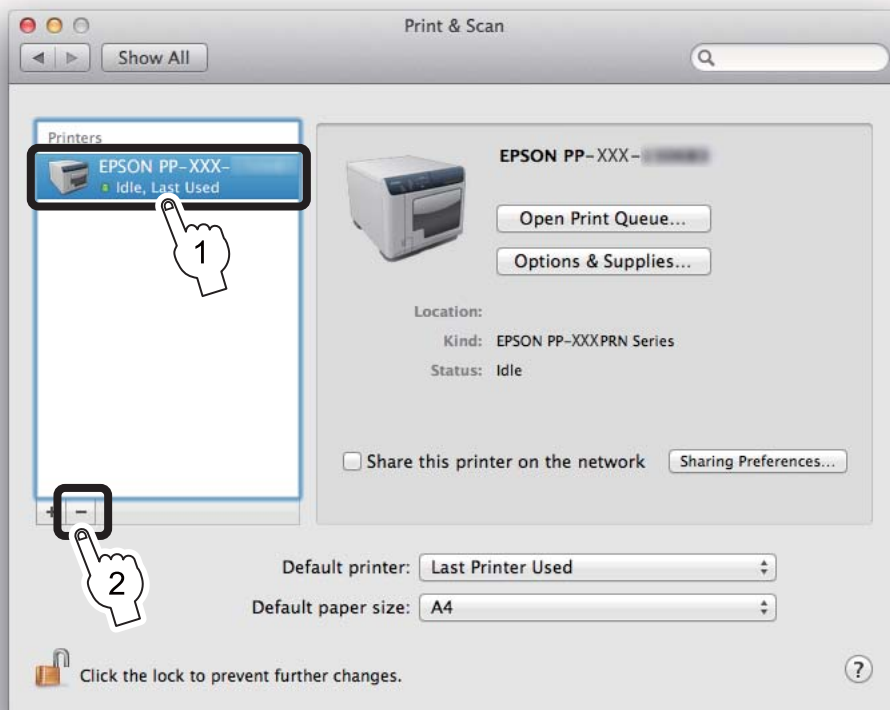
- 1 Turn off the product.
See “Turning Off the Power” on page 20.
- 2 Exit all applications that are running.
- 3 Click  [System Preferences] in the Dock.
- 4 Click  [Printers & Scanners] in Hardware.
- 5 Select the printer to be deleted, and click [-].



- 6 When the confirmation message appears, click **Delete Printer**.
- 7 Click  [Finder].
- 8 Click [Applications].
- 9 Click **EPSON Software**.
- 10 Click  [Uninstaller].
- 11 Select **Printer Driver**, and click **Uninstall**.

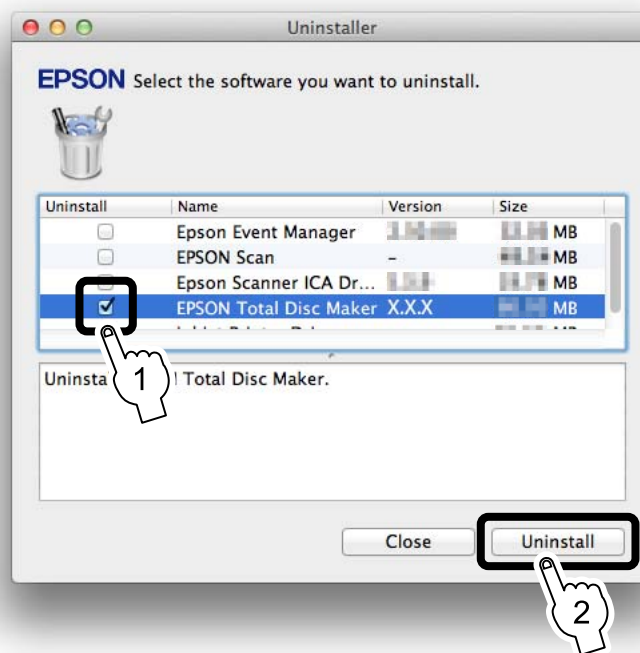

- 12 When the uninstall complete screen appears, click **Quit**.

Using Software

EPSON Total Disc Maker

What is EPSON Total Disc Maker?

EPSON Total Disc Maker is software for registering the write data* and the print data for the label surface, and publishing to this product (PP-100III/PP-50II/PP-100AP).

In EPSON Total Disc Maker, the execution of writing data* and printing labels is referred to as “publishing.” Publishing enables this product to write data to a CD or DVD and print the label to create a finished disc.

*: Writing data is not available with the PP-100AP.

Starting EPSON Total Disc Maker

- 1 Click  [Launchpad] in the Dock.
- 2 Click **EPSON Software**.
- 3 Click  [EPSON Total Disc Maker].
The EPSON Total Disc Maker starts.

Notes

If you drag and drop the [EPSON Total Disc Maker] icon to the Dock, the [EPSON Total Disc Maker] icon will be added in the Dock. After that, clicking the icon starts up the EPSON Total Disc Maker.

EPSON Total Disc Maker Help

EPSON Total Disc Maker Help contains the procedures for using and specifications of EPSON Total Disc Maker. Follow the steps below to display EPSON Total Disc Maker Help.

- 1 Start up EPSON Total Disc Maker.
- 2 Select **EPSON Total Disc Maker Help** from the **Help** menu.
EPSON Total Disc Maker Help appears.

Screen Configuration of EPSON Total Disc Maker

This section describes the screen configuration of EPSON Total Disc Maker.

See EPSON Total Disc Maker Help for details on use.

Disc view (only for PP-100III/PP-50II)

Starting EPSON Total Disc Maker or clicking **Disc** in Label view displays Disc view.

In Disc view, you can register the data to write to the disc. Disc view is not used with the PP-100AP.

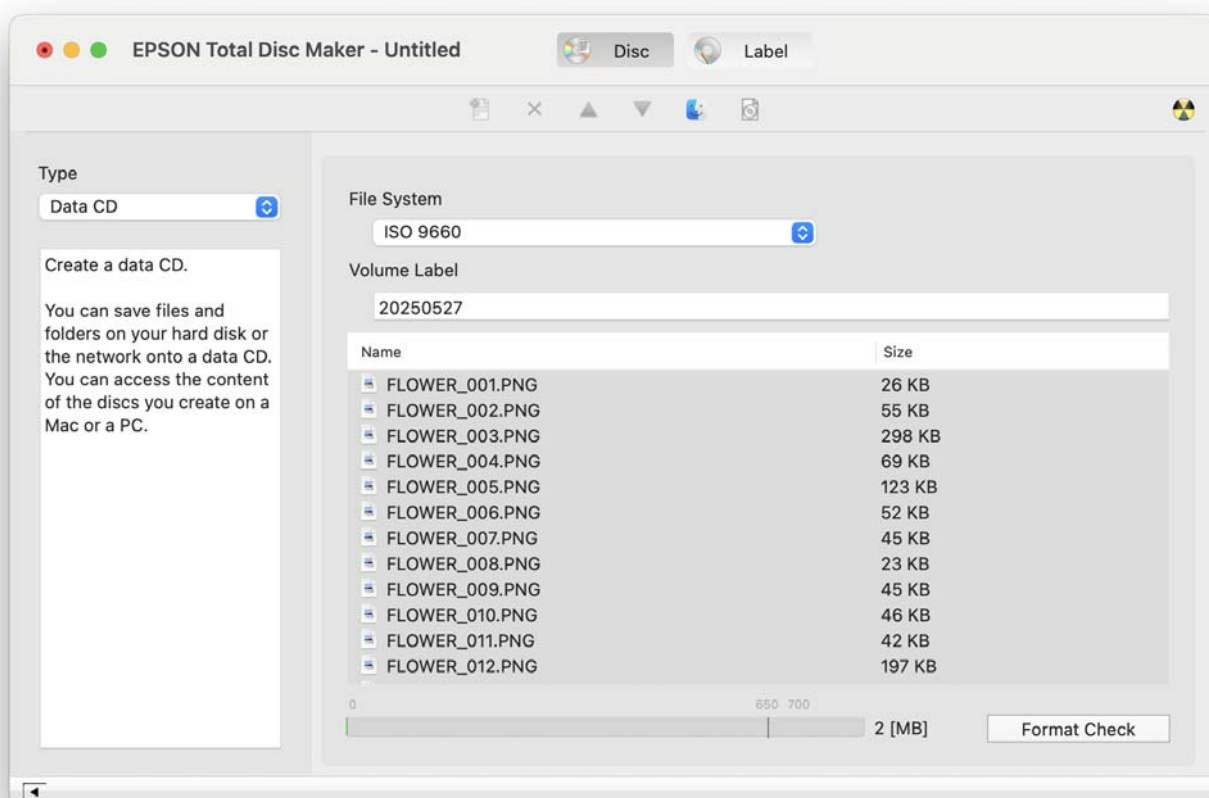

Label view

Clicking **Label** in Disc view displays Label view.

In Label view, you can edit the data for printing on the label surface of the disc.

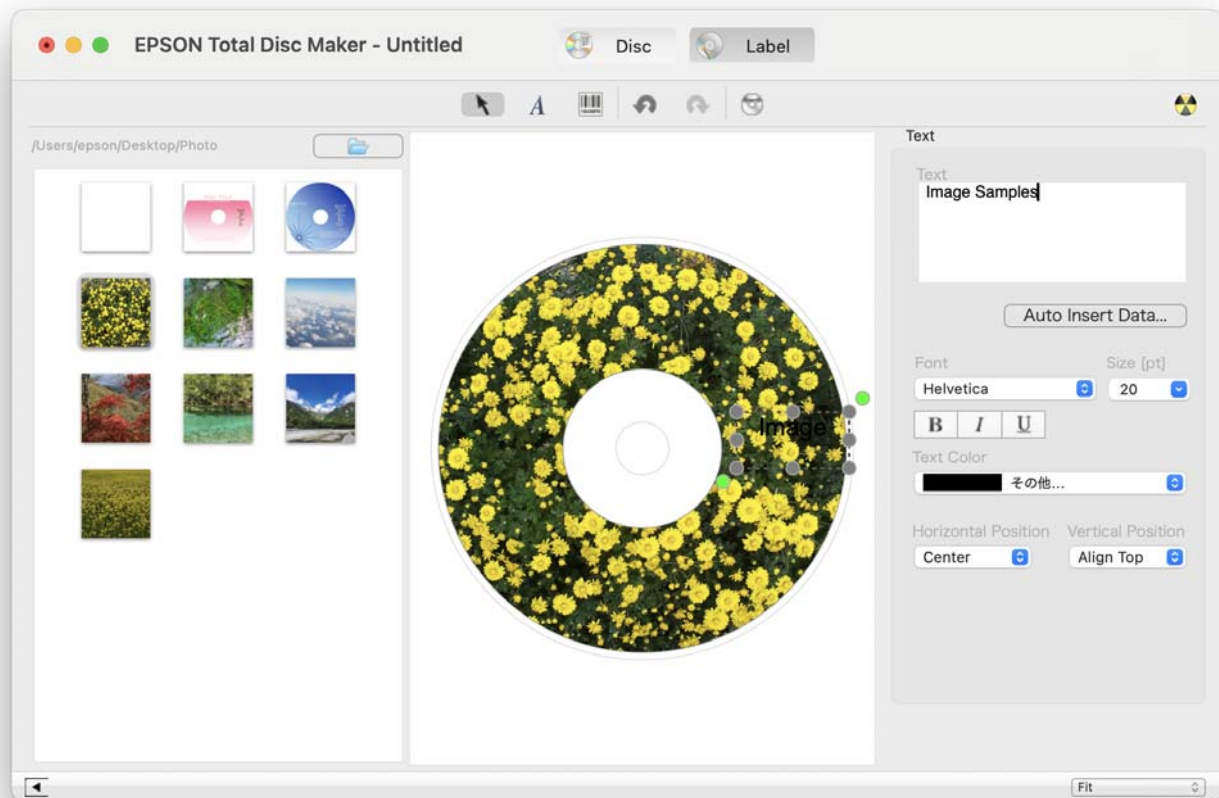

Publish view

Clicking  [Publish] in Disc view or Label view displays Publish view.

In Publish view, you can publish the writing data and label to this product.

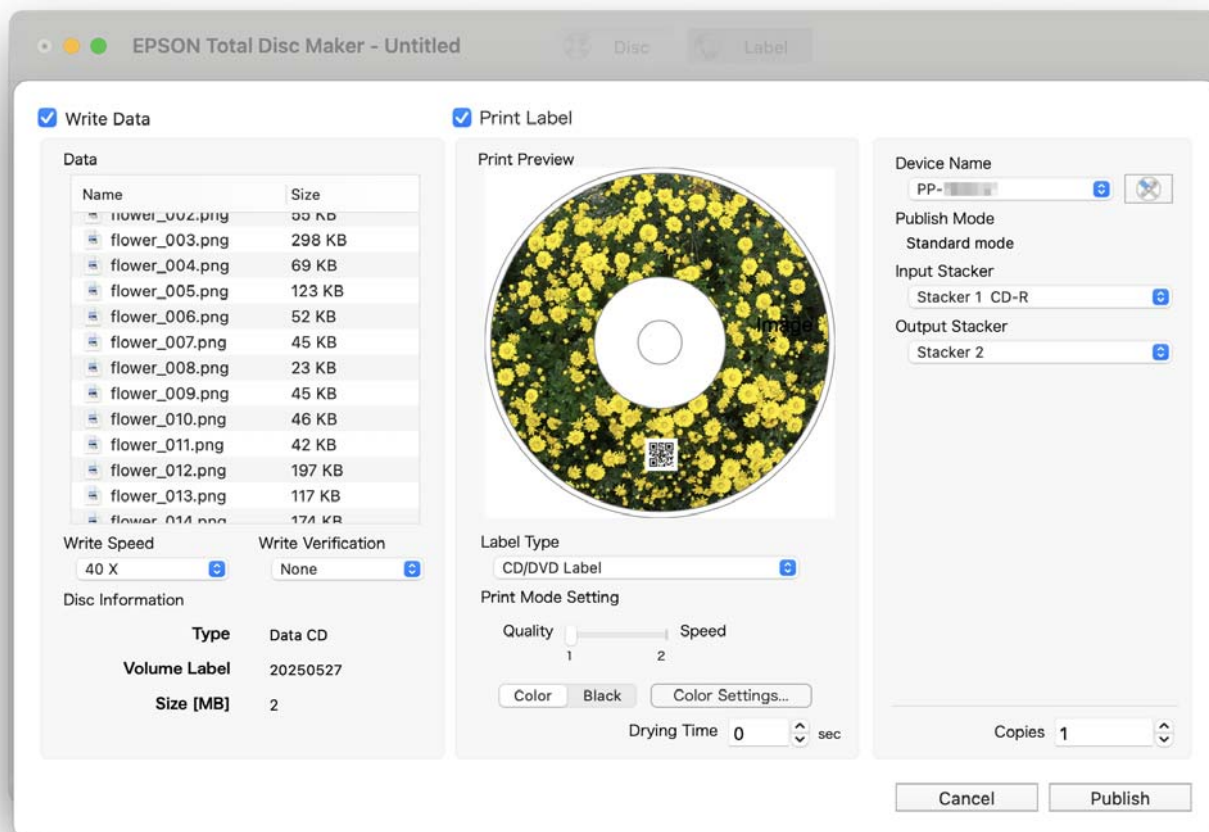



EPSON Total Disc Utility

What is EPSON Total Disc Utility?

EPSON Total Disc Utility is software for displaying the product's current status, remaining ink, job information, and other information, as well as for the basic settings for publishing discs with the product, such as settings for publish mode, stackers, and drives. You can also pause/cancel jobs and perform maintenance, such as running nozzle checks and cleaning the print head.

Starting EPSON Total Disc Utility

- 1 Click  [Launchpad] in the Dock.
- 2 Click **EPSON Software**.
- 3 Click  [EPSON Total Disc Utility].
The EPSON Total Disc Utility starts.

Notes

- If you drag and drop the **EPSON Total Disc Utility** icon to the Dock, the **EPSON Total Disc Utility** icon will be added in the Dock. After that, clicking the icon starts up EPSON Total Disc Utility.
- You can also start EPSON Total Disc Utility by clicking **Publish** in EPSON Total Disc Maker.

EPSON Total Disc Utility Help

EPSON Total Disc Utility Help contains the procedures for using and specifications of EPSON Total Disc Utility. Follow the steps below to display EPSON Total Disc Utility Help

- 1 Start up EPSON Total Disc Utility.
- 2 Select **EPSON Total Disc Utility Help** from the **Help** menu.
EPSON Total Disc Utility Help appears.

Screen Configuration of EPSON Total Disc Utility

This section describes the screen configuration of EPSON Total Disc Utility.

See EPSON Total Disc Utility Help for details on use.

Main screen

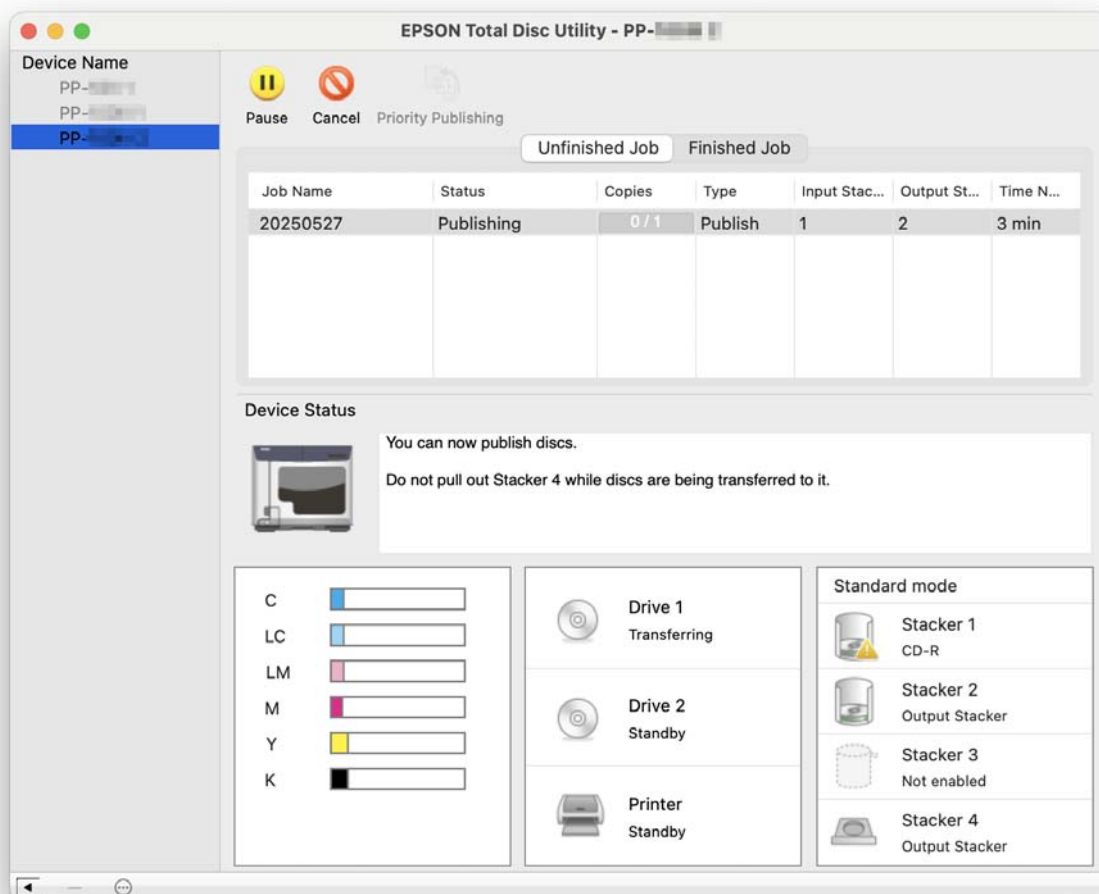

Click the **Unfinished Job** tab and **Finished Job** tab to display each screen.

Unfinished Job screen

The **Unfinished Job** screen displays information on job status.

Selecting a job enables you to click [Pause], [Resume], [Cancel], or [Priority Publishing].

Finished Job screen

The **Finished Job** screen displays information on jobs for which publishing is finished.

Double-clicking a job displays detailed job information.

Properties screen (General screen)

On the Main screen, double-click a model name for **Device Name** or click  [**Properties**] to display the device's **Properties** screen.

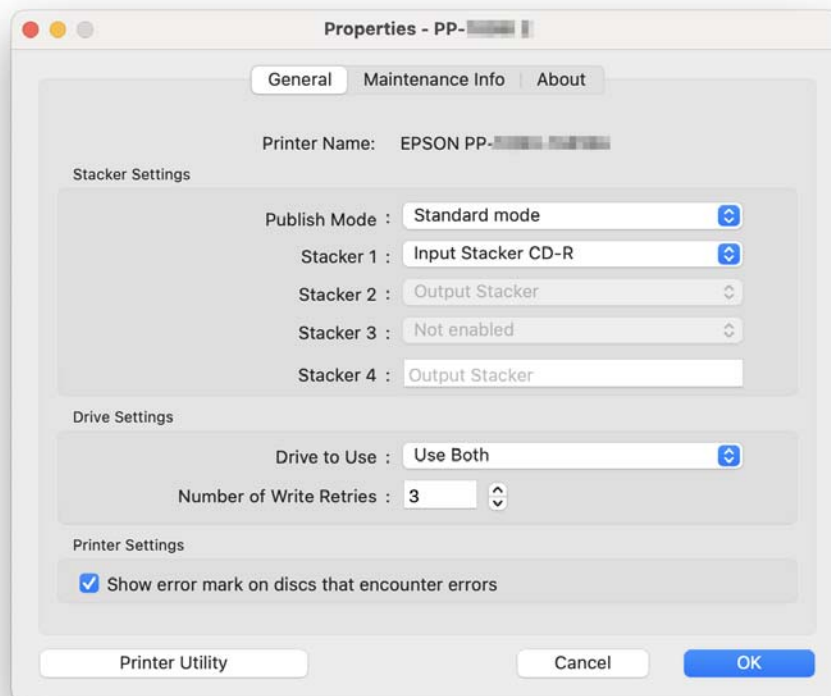

Notes

You can also display the **Properties** screen by clicking  in Publish view of EPSON Total Disc Maker.

Click the **General** tab, **Maintenance Info** tab, and **About** tab to display each screen.

Click **Printer Utility** in each screen to display the **Printer Utility** screen.

Maintenance Info screen

In the **Maintenance Info** screen, you can check maintenance information for your product.

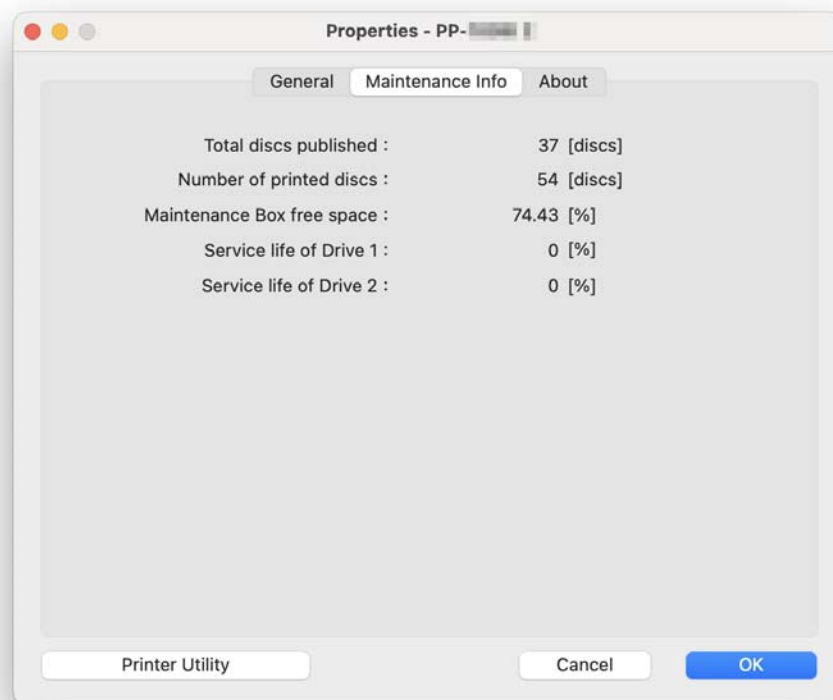

Notes See ["Checking Maintenance Information"](#) on page 100 for details.

About screen

In the **About** screen, you can check the serial number and versions for your product.

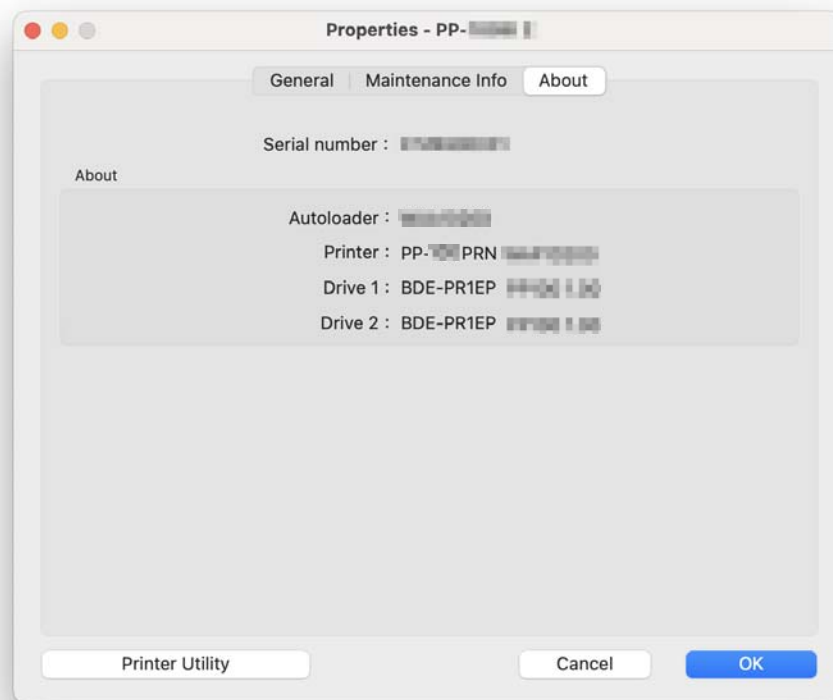

Printer Utility screen

In the **Utility** screen, you can run various maintenance functions to maintain the print quality.

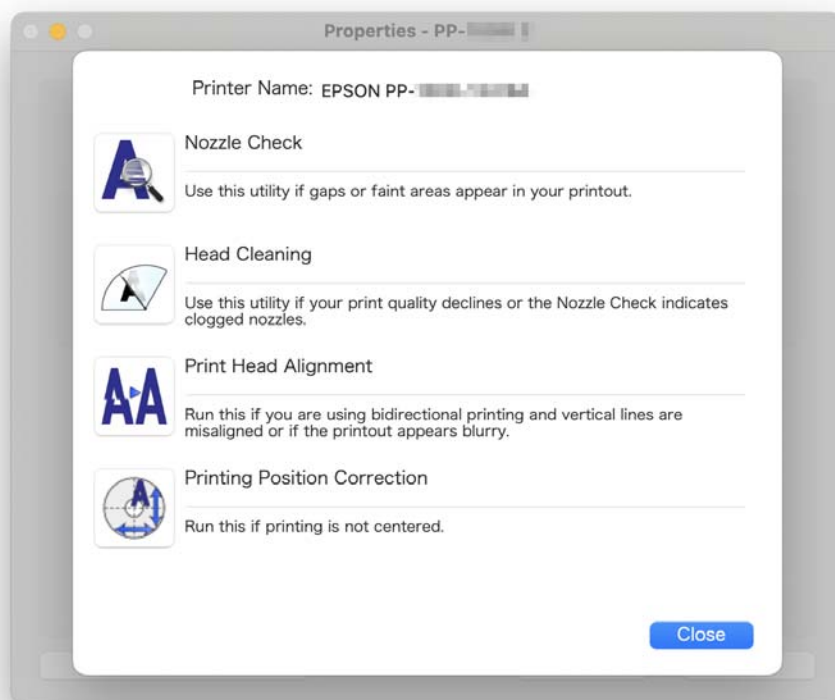

Notes

- For details on **Nozzle Check**, see ["Checking the Print Head Nozzles"](#) on page 85.
- For details on **Head Cleaning**, see ["Cleaning the Print Head"](#) on page 87.
- For details on **Print Head Alignment**, see ["Aligning the Print Head"](#) on page 90.
- For details on **Printing Position Correction**, see ["Correcting the Printing Position"](#) on page 93.

Printer Driver

What is the Printer Driver?

The printer driver is software that allows you to make the necessary settings for publishing discs using commercially available applications other than EPSON Total Disc Maker, such as Illustrator.

Displaying the Printer Driver Screen

Select **Print...** from the **File** menu of your application to display the setting screen of the printer driver.

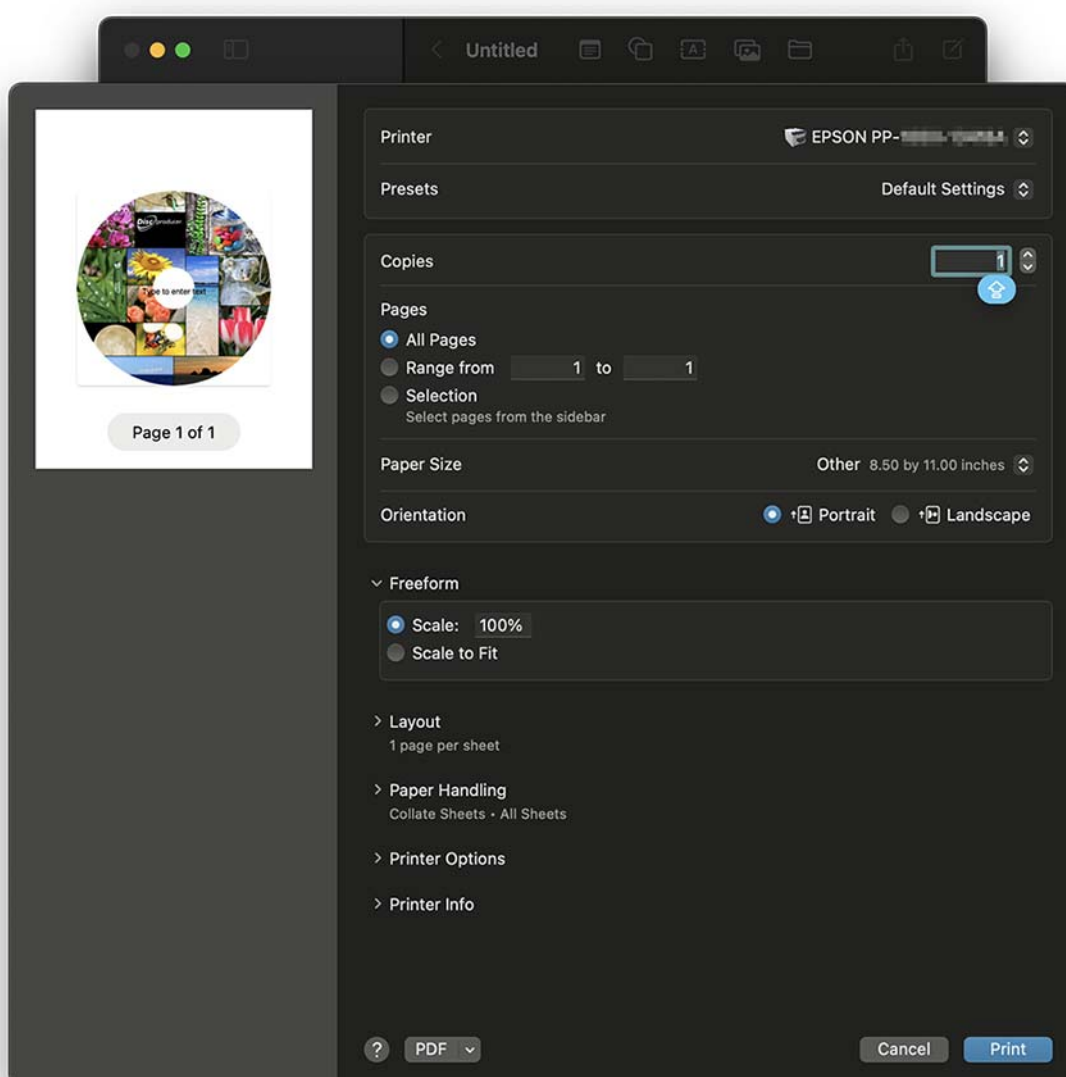

Screen Configuration of Printer Driver

This section describes the screen configuration of the printer driver.

Notes

- After setting, you can store the current setting as a preset. However, some items of the preset setting may not be reflected if the current publish mode is different from the publish mode when the preset was stored.
- The operation of **Layout**, **Paper Handling**, **Cover Page**, and **Scheduler** in the printer driver is not guaranteed.

Print Settings area

In the **Print Settings** area, you can configure basic settings for label printing and disc image file setting to write data onto discs.

Display the printer driver screen, and select **Print Settings** to display the **Print Settings** area.

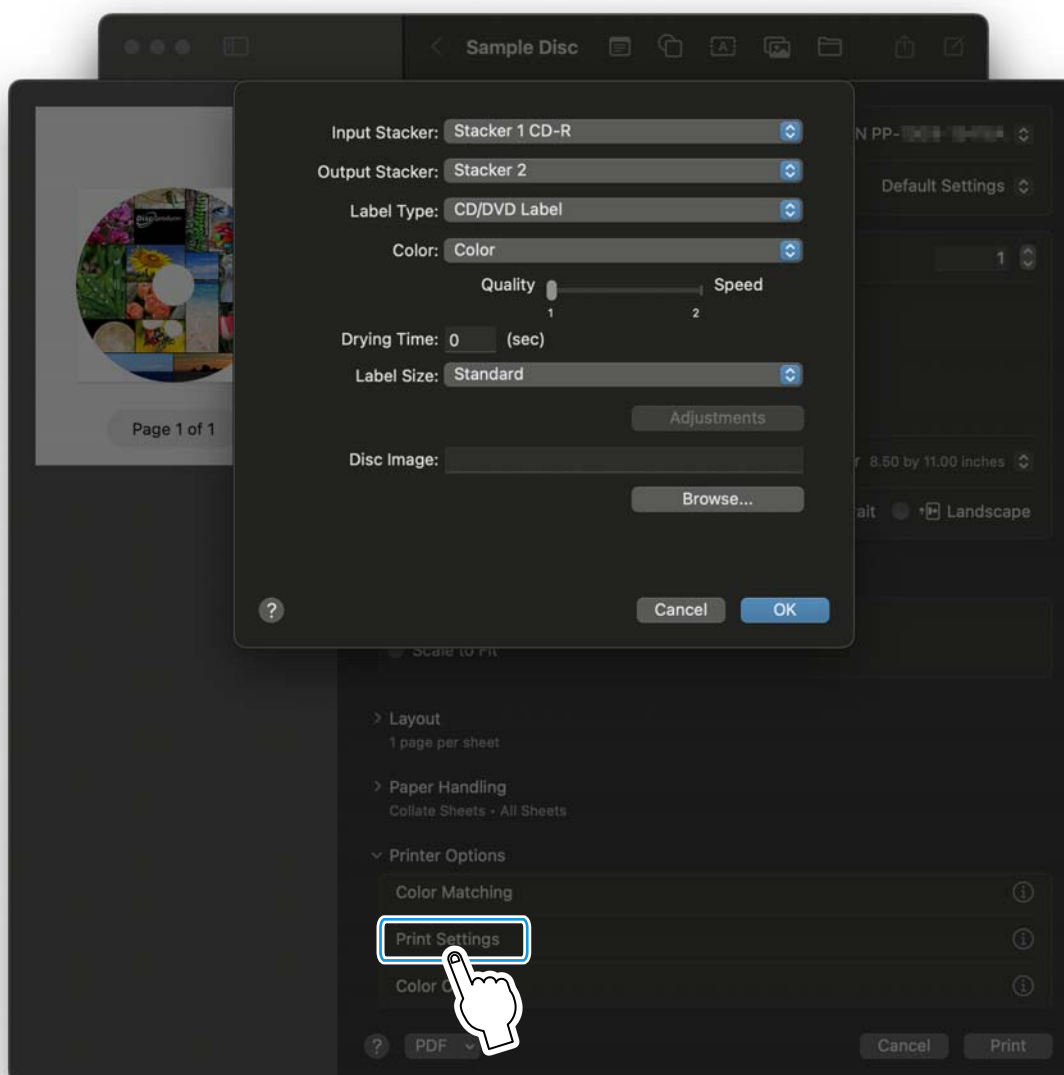

Input Stacker	Allows you to select the stacker where the discs to be written/printed are set.	
Output Stacker	Allows you to select the stacker to which to output published discs.	
Label Type	Allows you to select the type of disc label to be printed.	
Color	Select Color to print in color, and select Black for monochrome printing.	
Quality/ Speed	PP-100III/ PP-50II	1: Prints labels with an emphasis on printing quality. 2: Prints labels with an emphasis on printing speed.
	PP-100AP	1: Prints labels with an emphasis on printing quality. 2: Prints labels with an emphasis on printing speed. 3: Prints labels with even more emphasis on speed than when this is set to 2.
Drying Time	Allows you to set the time taken to dry the ink on the discs in the printer tray after label printing is finished.	
Label Size	Allows you to select from among the following label sizes. <ul style="list-style-type: none"> • Standard: Outside Diameter 116.0 mm, Inside Diameter 45.0 mm • Wide: Outside Diameter 116.0 mm, Inside Diameter 25.5 mm • User Defined: Allows you to set a custom size 	
Disc Image (only for PP-100III/PP-50II)	Allows you to specify a disc image file if you write data onto a disc at the same time as label printing.	



- If you print on the matte label type of Epson specified CDs, set **Label Type** to **CD/DVD Label**.
- If you print on the matte label type of Epson specified DVDs, set **Label Type** to **CD/DVD Premium Label**.
- If **Label Type** is set to **EPSON Specified CD/DVD Label**, **Quality/Speed** is set to **1**.
- For setting the user defined label size, see ["Printing on User Defined Label Size Discs" on page 75](#).
- When publishing from Adobe Photoshop, the **Copies** cannot be specified.

Color Options area

In **Color Options** area, you can adjust print colors.

Display the printer driver screen, and select **Color Options** to display the **Color Options** area.

Notes

- If you wish, you can make color adjustments at the time of printing without making color adjustments to the actual data.
- If **Color** is set to **Black** in the **Print Settings** area, color adjustments cannot be made.
- For adjusting print colors, see [“Adjusting Print Colors” on page 79](#).

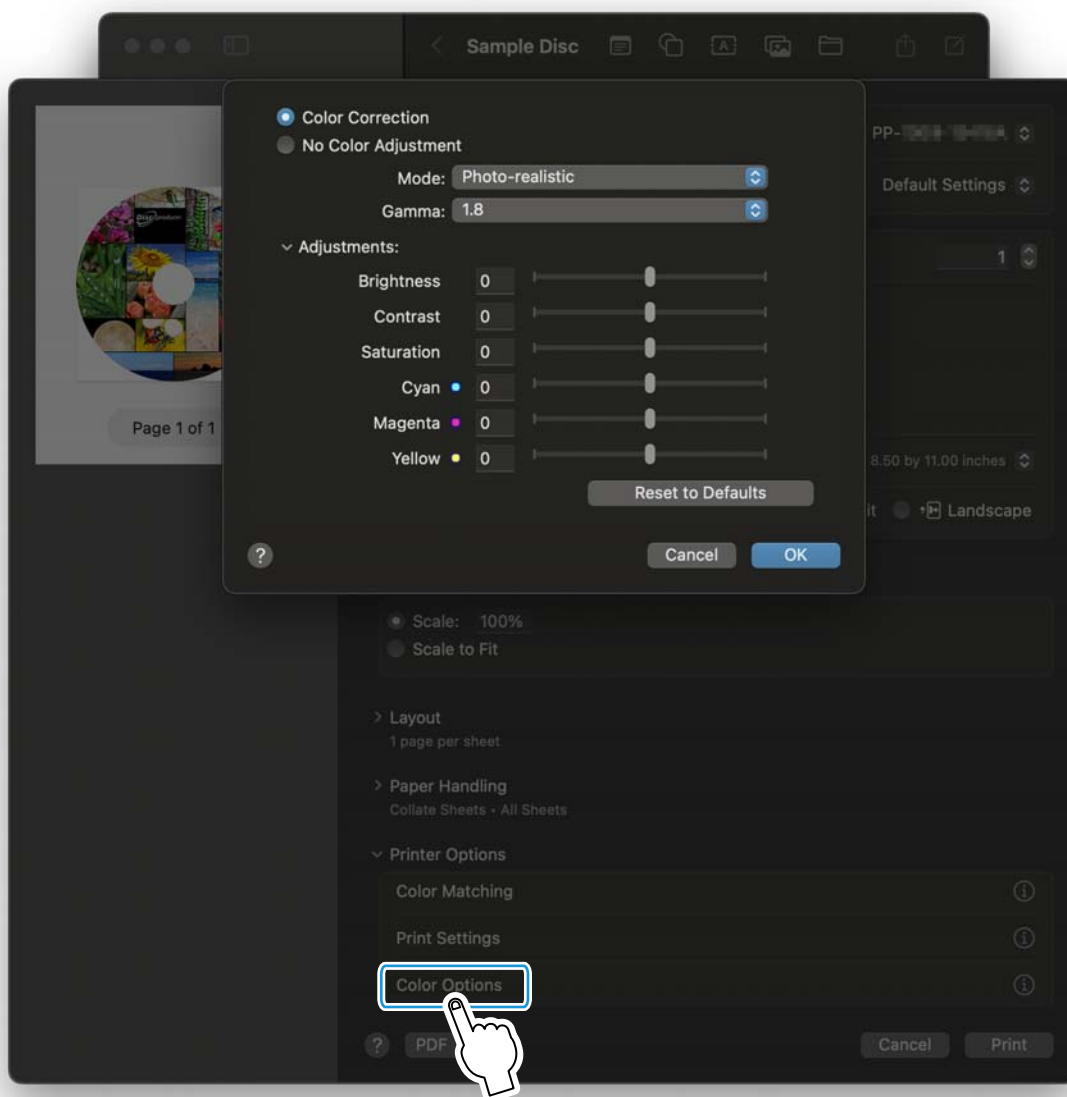

Publishing Discs

Compatible Disc Types

Printable disc and writable disc types differ. When using this product for both printing and writing*, use discs that are compatible with both.

* Writing data is not available with the PP-100AP.

Printable Disc Types

The product can print on 12-cm CD/DVD discs that support using an inkjet color printer to print on the label surface*.

* Discs for which “printable label surface,” “inkjet printer compatible,” or the like is specified in the instructions for the discs.



- The product supports discs for inkjet printers. It does not support discs for thermal transfer printers.
- Glossy discs other than Epson specified CDs/DVDs are not supported.
- 80-mm discs are not supported.
- Do not use discs that have lens cleaner, labels or stickers, or condensation on them. Doing so may result in an malfunction or failure.
- Do not use a cracked, warped, or deformed disc. The disc may break into pieces inside the product, resulting in a malfunction, or an injury when the disc is taken out.
- With some discs, ink may get on the recording surface if the discs are stacked immediately after printing. We recommend using a disc you do not need to do a test print to check the print quality. Wait at least 24 hours before checking the color.
- With some discs, the printing position may be shifted. Perform the print head alignment and the printing position correction. (See [“Aligning the Print Head” on page 90](#) and [“Correcting the Printing Position” on page 93](#).)
- If you use discs with a small stack ring (concentric circular projection), the discs may stick to each other before or after printing.
- Even if the same data is printed on identical discs, the same print results may not be able to be achieved because of the individual differences (variations) of each disc.

Notes

Disc quality may affect print quality. We recommend using Epson specified CDs/DVDs. Epson offers specified CD-R and DVD-R discs for all your printing needs.

Writable Disc Types

The PP-100III and PP-50II can write to the following types of disc.

Type	Capacity	Characteristics
CD-R	650/700 MB	The rewriting and deleting of data is not possible once data has been written.
DVD-R	4.7 GB (single sided, single layer)	The rewriting and deleting of data is not possible once data has been written. This is a standard DVD defined by the DVD Forum.
DVD+R	4.7 GB (single sided, single layer)	The rewriting and deleting of data is not possible once data has been written. This is a standard DVD defined by the DVD+RW Alliance.
DVD-R DL	8.5 GB (single sided, double layer)	The rewriting and deleting of data is not possible once data has been written. This disc allows double-layer recording on a single side. This increases the capacity, thus enabling recording for a long time or recording of high-quality video. This is a standard DVD defined by the DVD Forum.
DVD+R DL	8.5 GB (single sided, double layer)	The rewriting and deleting of data is not possible once data has been written. This disc allows double-layer recording on a single side. This increases the capacity, thus enabling recording for a long time or recording of high-quality video. This is a standard DVD defined by the DVD+RW Alliance.



- 80-mm discs are not supported.
- Do not use discs that have lens cleaner, labels or stickers, or condensation on them. Doing so may result in an malfunction or failure.
- Do not use a cracked, warped, or deformed disc. The disc may break into pieces inside the product, resulting in a malfunction, or an injury when the disc is taken out.
- Writing (reading) may not be performed properly if a disc has a slight scratch or is dirty. Be sufficiently careful when handling discs.
- Depending on the discs used, writing may not be able to be performed properly at the speed recommended for the disc. If this happens, write at a slower speed. In particular, we recommend writing to DVD±R DL at a slow speed.
- Layer jump recording is not supported.

Notes

- Disc quality may affect write quality. We recommend using Epson specified CDs/DVDs. Epson offers the specified CD-R and DVD-R discs for all your printing needs.
- See EPSON Total Disc Maker Help for details on writable disc types.

Handling Discs

Notes on Usage



- Do not touch the recording surface when holding a disc.
- Handle discs carefully to ensure fingerprints, dirt, dust, moisture, scratches, etc., do not get on the label surface and recording surface. Gently wipe off any dust, dirt, and the like with a soft dry cloth or a commercially available CD cleaner. Do not use benzene, thinner, or antistatic agents.
- Do not drop a disc, or subject it to an impact.
- Do not apply excessive force by, for example, pinching with a clip or bending.
- Do not attach an adhesive sticker to a disc. Doing so may result in writing, printing, or playing no longer being possible.
- Do not use discs in a place where lots of dirt and dust are present.
- If writing and printing are performed separately, we recommended performing writing before printing.
- Leaving discs stacked may result in them sticking to each other.
- Directly touching or getting moisture on the printing surface immediately after printing may result in blurring.
- Let discs dry sufficiently after printing. However, let them dry naturally. Do not use a dryer or other means.
- Text can be written only on the printing surface. When writing, use a felt tipped pen or other writing instrument with a soft tip. Do not use a ballpoint pen, pencil, or other writing instrument with a hard tip. Also, do not attempt to erase text once it has been written.
- Do not use a disc printed with this product in an auto loading mechanism, a drive with a holding mechanism that has diameter of 33 mm or more, or an in-car drive. Also, do not leave a disc in equipment for a long period of time.
- A published disc may not be able to be recognized if it is incompatible with the drive or player.

Notes on storage



- Do not place discs in a location where they will be subject to high temperature and humidity such as locations under direct sunlight, near heating equipment.
- Do not place discs in locations where temperatures vary greatly. Doing so may result in condensation.
- Do not place an object on a disc.
- When storing discs, keep them in their disc cases and take care that film, card, or other material does not touch the printing surface. Such materials may scratch the printing surface.
- Do not store discs in soft cases or bags that may touch the printing surface directly. Doing so may result in discs sticking, uneven color, or discoloration.
- Do not store discs with part of the printing surface covered. Doing so may cause uneven color or discoloration.
- Back up (copy) important data just in case. When storing data for a long period of time, we recommend backing it up periodically.

Notes

See the instruction manual of the discs for other handling procedures and precautions for discs.

Printable Area

The printable area is the area of the label surface on which printing is possible.

The printable area and recommended print area are shown in the table below. Printing will be done in the gray area in the figure below.



- Printing outside of the recommended print area may result in the discs or tray becoming dirty, peeling off or blurring of the print, or discs sticking together.
- If you print outside of the printing range (ink absorbing layer) of the discs you are using, the ink printed outside the printing area will not fix. Check the label print range of the discs you are using before configuring the setting.

Printable area		Recommended print area	
Inside Diameter	Outside Diameter	Inside Diameter	Outside Diameter
18.0 mm	119.4 mm	45.0 mm	116.0 mm

Setting the Print Area

Select from **Standard** and **Wide**, or set an arbitrary size (**User Defined** label size).

The print areas of **Standard** and **Wide** are shown in the table below. Printing will be done in the gray area in the figure below.

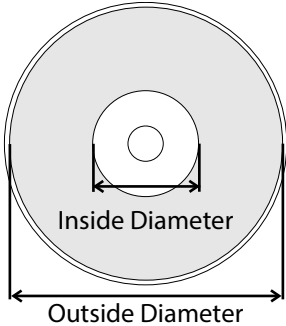
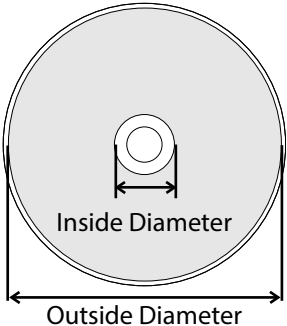
Standard		Wide	
			
Inside Diameter	Outside Diameter	Inside Diameter	Outside Diameter
45.0 mm	116.0 mm	25.5 mm	116.0 mm



- Before printing, check that the set print area does not exceed the print area of the discs you are using.
- Printing on the stack ring (concentric circular projection) portion may result in uneven coloring.
- Printing on the stack ring (concentric circular projection) portion may result in ink getting on the discs, peeling off, or discs sticking together after printing.

Notes

- See [“Printing on User Defined Label Size Discs” on page 75](#) for the setting procedure of the user defined label size.
- When printing with applications other than EPSON Total Disc Maker, use the following settings to create print data.
 - * Paper size: 124 x 124 mm
 - * Margins on all sides: 2 mm

The setting procedure of the print area differs, depending on whether you publish with EPSON Total Disc Maker or with the other applications.

When publishing with EPSON Total Disc Maker

Set in the dialogue that is displayed when you click  [Set Inner/Outer Diameter] in Label view of EPSON Total Disc Maker.

When publishing with the other applications

Set in **Label size** in the **Print Settings** area of the printer driver.

Flow for Publishing Discs

This section describes how to publish discs using the product.

The publishing procedure differs, depending on whether you publish with EPSON Total Disc Maker or with other applications.



- If you publish a large number of discs, first publish one disc and check the write result and print result.
- When the product is used for the first time, after it has been stored for a long time, or after an error occurs, missing dots or ink stains may appear and print quality may be reduced on rare occasions. When publishing multiple discs, publish one disc in advance and check that there are no missing dots. If any dots are missing, perform head cleaning. (See [“Cleaning the Print Head”](#) on page 87.)
- If writing and printing are performed separately, performing writing before printing is recommended. If writing is performed after printing, ink may cause discs to stick to each other and result in a disc transport error, or dirt, stains, or scratches on discs may result in a write error.

When publishing with EPSON Total Disc Maker

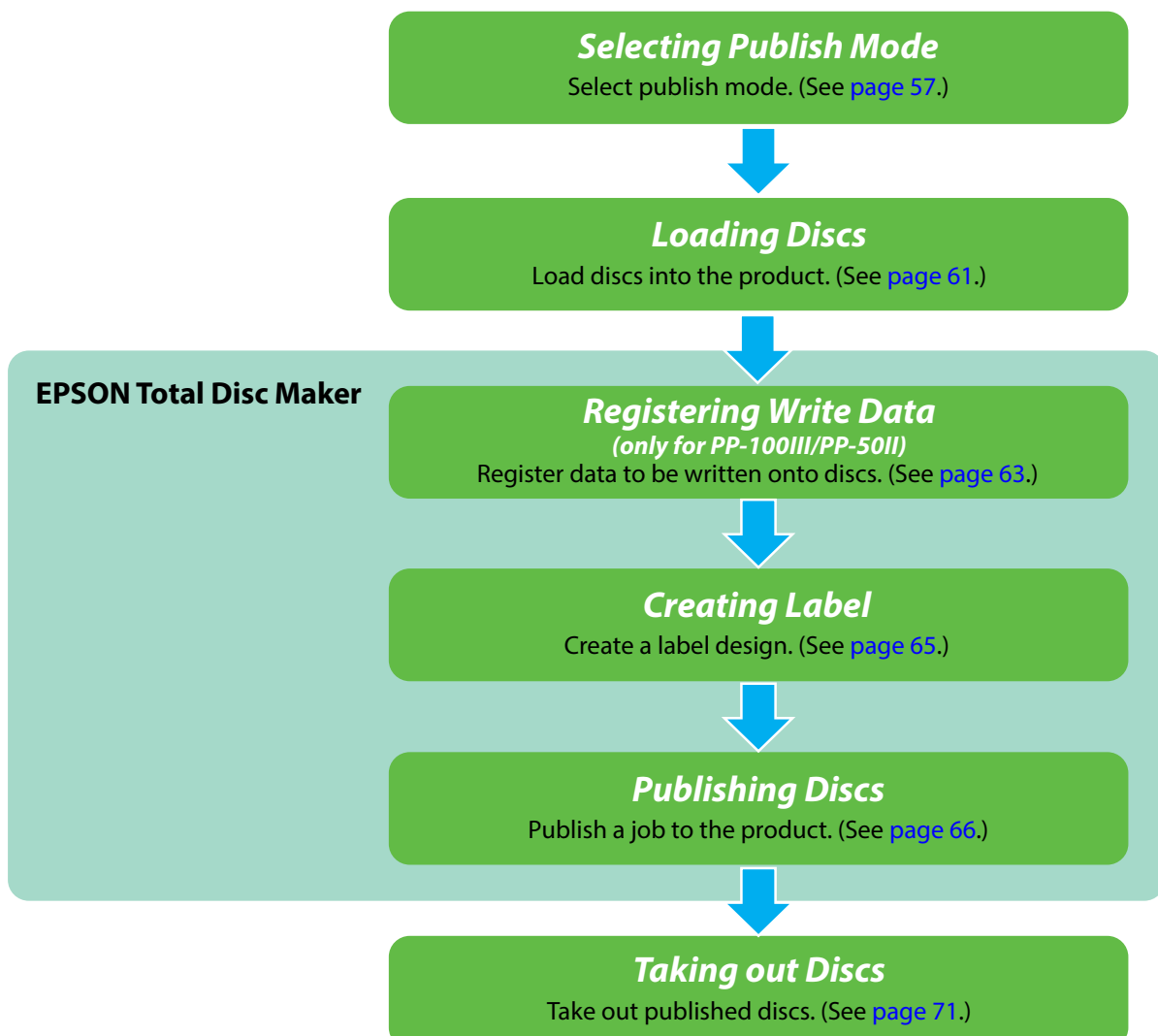

When publishing with the other applications

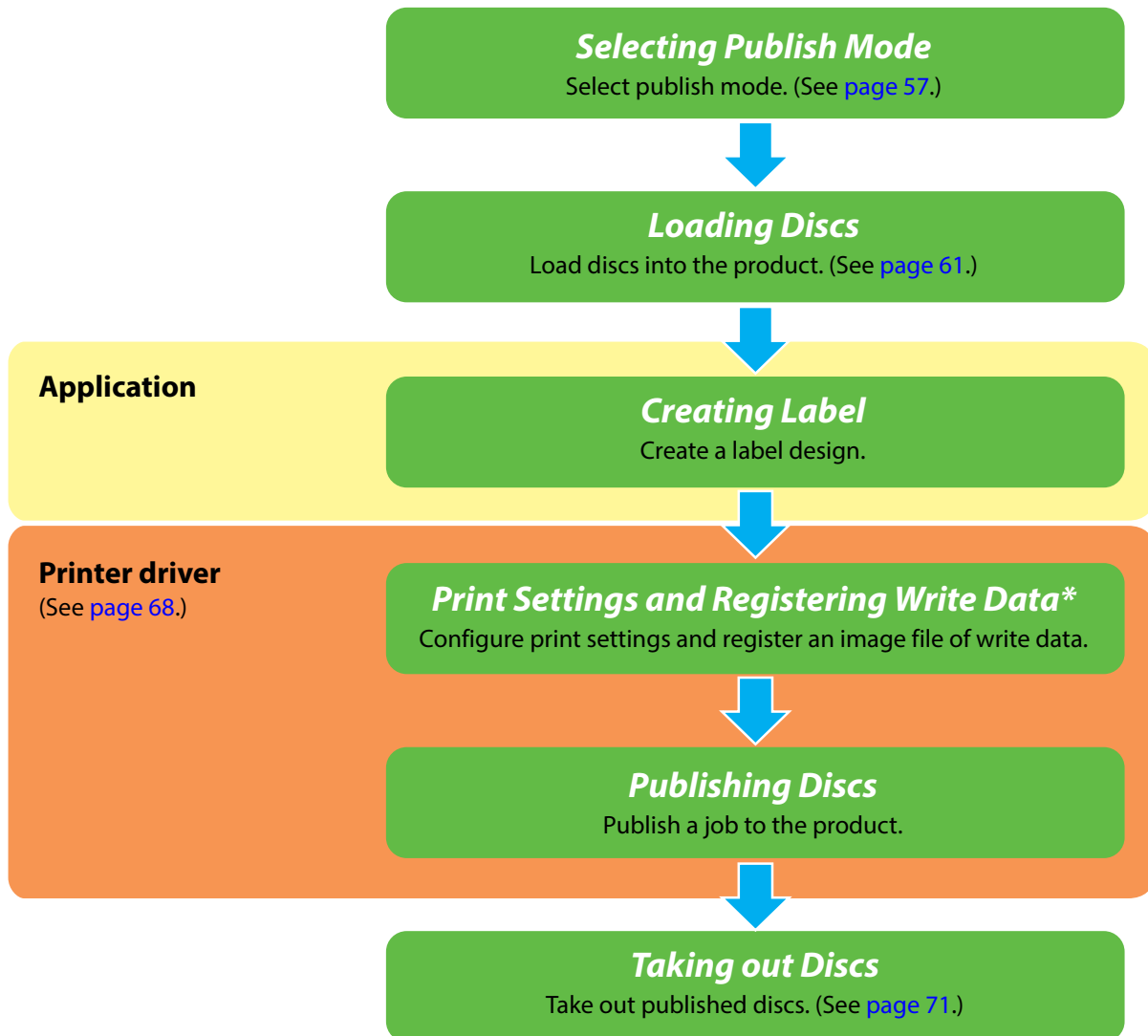

* Registering write data is not available with the PP-100AP.

Notes

With the PP-100III or PP-50II, if you specify an image file in the print settings, writing data onto a disc is possible at the same time as label printing. See "Print Settings area" on page 46 for specifying an image file.

Selecting Publish Mode

Setting the most suitable publish mode for the usage or number of discs to be published enables efficient disc publishing.

Select the publish mode, referring to the following descriptions, and change the setting in the properties setting if necessary. For properties setting procedure, see [“Properties Setting” on page 28](#).

Notes

If you publish with EPSON Total Disc Maker, you can change the publish mode setting in Publish view.

The PP-100III and PP-100AP have three publish modes, Standard mode, External Output mode, and Batch mode. The PP-50II has two publish modes, Low-volume mode and Standard mode.

For PP-100III/PP-100AP

Standard mode: When you want to publish up to 50 identical discs at once

This mode uses Stacker 1 as the input stacker for discs. You can select Stacker 2 or Stacker 4 as the output stacker.

If you select Stacker 2 as the output stacker, you can publish up to 50 discs without having to replenish the discs or take out published discs.

If you select Stacker 4 as the output stacker, you can easily take out published discs without even having to pause a job during publishing up to 50 discs.

Repeatedly replenishing and taking out discs allows for the continuous publishing of up to 1,000 discs.

- When you select Stacker 2 as the output stacker

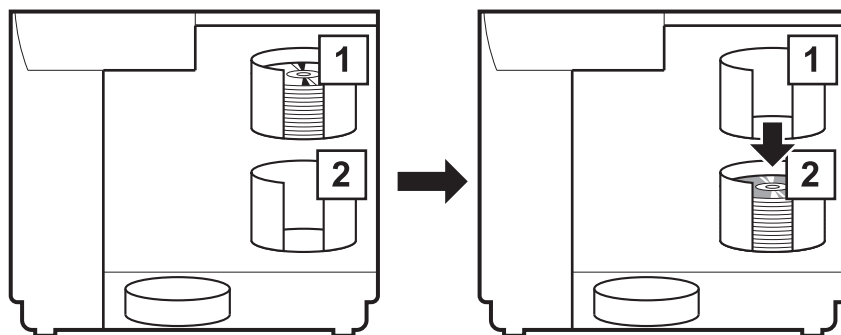

- When you select stacker 4 as the output stacker

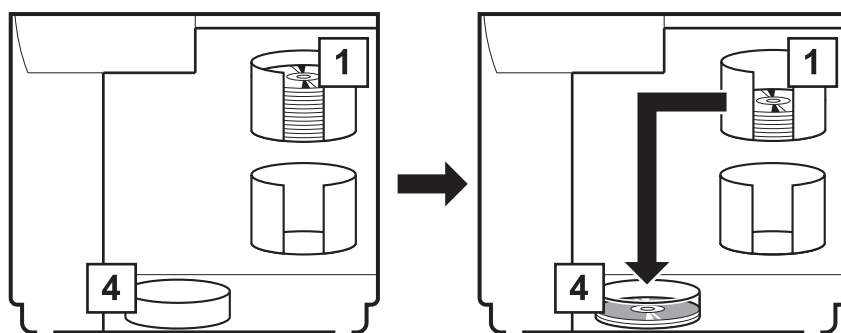

External Output mode:

When you want to publish two type of discs without having to change discs

This mode uses Stacker 1 and Stacker 2 as the input stackers for discs. You can select Stacker 3 or Stacker 4 as the output stacker.

If, for example, CD-Rs are loaded in Stacker 1 and DVD-Rs are loaded in Stacker 2, you can just select a stacker as necessary to publish the required discs without having to change the discs.

If you select Stacker 4 as the output stacker, you can easily take out published discs without even having to pause a job during publishing.

- When you select Stacker 3 as the output stacker

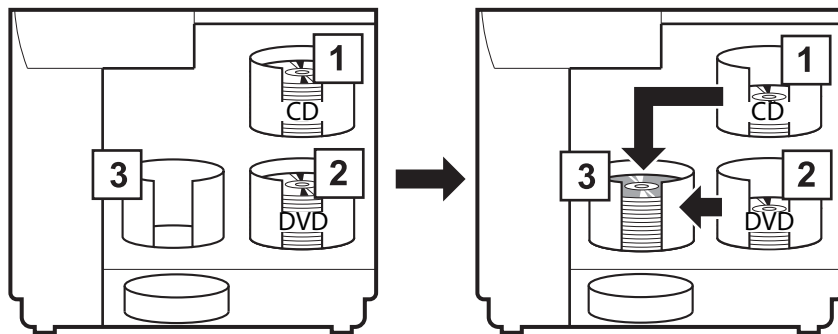

- When you select Stacker 4 as the output stacker

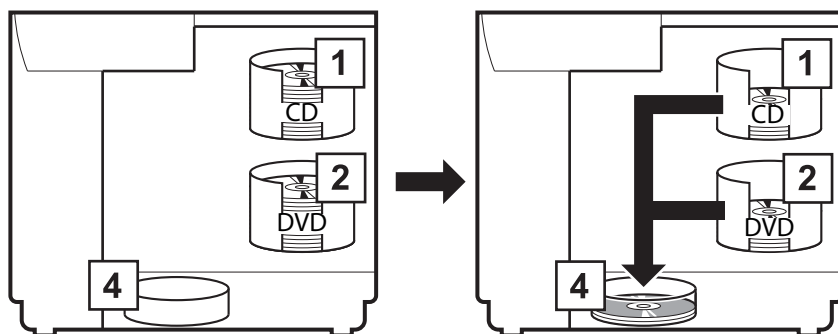

Batch mode: When you want to publish a large number of discs with least labor

This mode uses Stacker 1 and Stacker 2 as the input stackers for discs, and Stacker 2 and Stacker 3 as the output stackers.

Loading 50 discs into each of Stacker 1 and Stacker 2 allows for the continuous publishing of 100 copies of the same disc without having to replenish the discs or take out published discs.

Repeatedly replenishing and taking out discs allows for the continuous publishing of up to 1,000 discs.

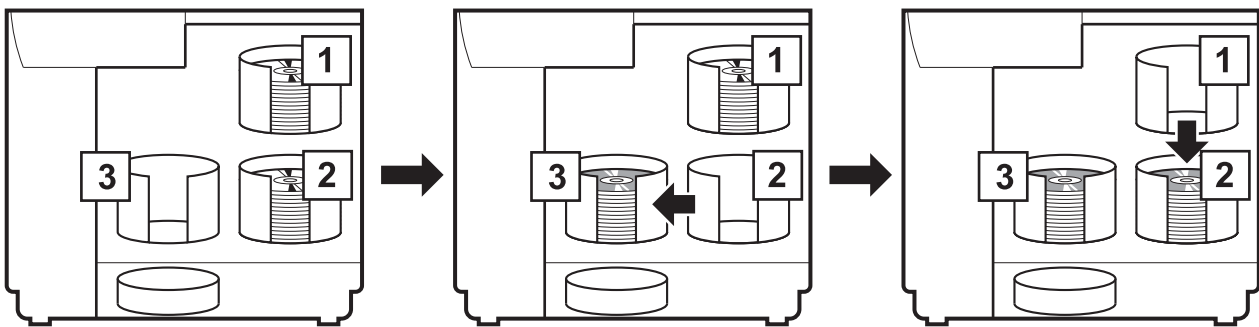

Notes

When discs are published in Batch Mode, the number of discs loaded into Stacker 2 and the number of discs output to Stacker 3 do not always match. Also, 50 discs may not be output. The same applies for the discs output to Stacker 2.

In Batch Mode, once the height of the stack of discs output to Stacker 3 reaches the maximum value, the output staker is switched to Stacker 2. Therefore, the number of discs output to a staker differs depending on the thickness of the discs used.

For PP-50II

Standard mode: When you want to publish up to 50 identical discs at once

This mode uses Stacker 1 as the input stacker for discs. You can select Stacker 2 or Stacker 3 as the output stacker.

If you select Stacker 2 as the output stacker, you can publish up to 50 discs without having to replenish the discs or take out published discs.

Repeatedly replenishing and taking out discs allows for the continuous publishing of up to 1,000 discs.

- When you select Stacker 2 as the output stacker

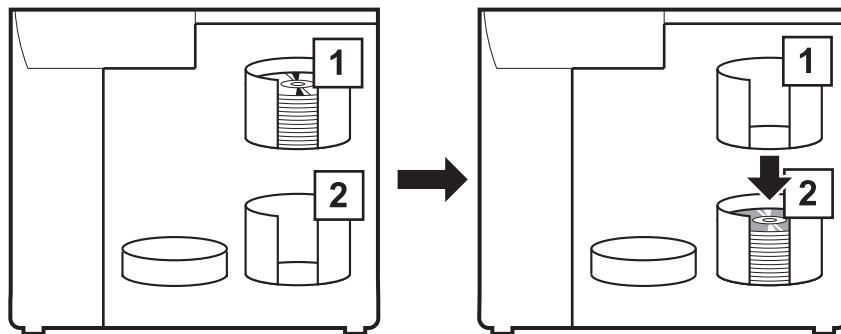

- When you select stacker 3 as the output stacker

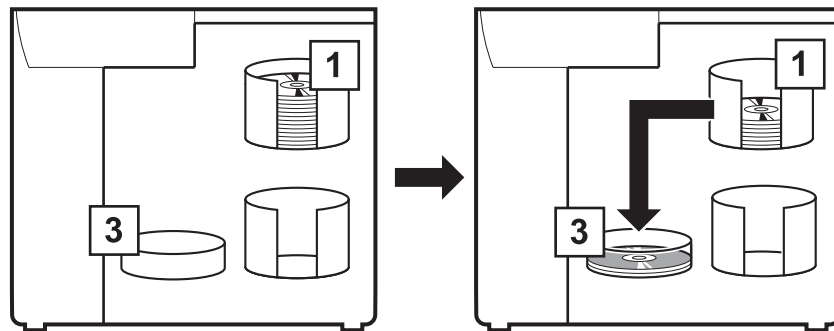

Low-volume mode:

When you want to publish two type of discs without having to change discs

This mode uses Stacker 1 and Stacker 2 as the input stackers for discs. Published discs are output to Stacker 3.

If, for example, CD-Rs are loaded in Stacker 1 and DVD-Rs are loaded in Stacker 2, you can just select a stacker as necessary to publish the required discs without having to change the discs.

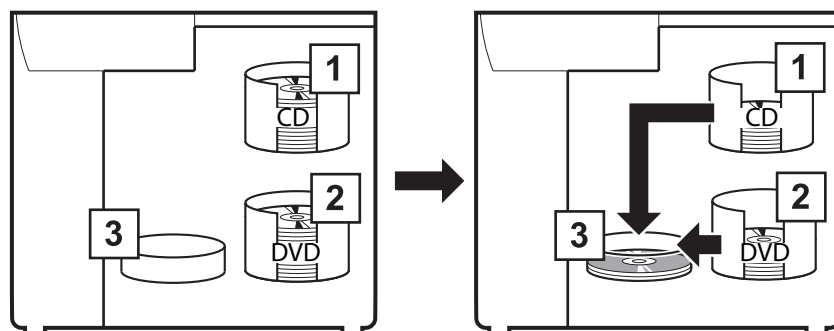

Loading Discs

This section describes how to load discs into the input stacker, and insert it.



Load the discs into a stacker. Do not load discs in the drives or printer. Furthermore, with the PP-100III, do not load discs between Drive 1 and Drive 2. They may become unable to be removed.

1 Fully separate the discs to prevent them from sticking together.



- Be sufficiently careful not to scratch a disc.
- If a long time elapses after discs are loaded in the stacker, the separated discs may stick together again. Fan the discs again if a long time has elapsed since they were loaded.

2 Open the disc cover.

For precautions when you open the disc cover, see [“Opening the Disc Cover” on page 21](#).

3 Take out the input stacker and load the discs into it.

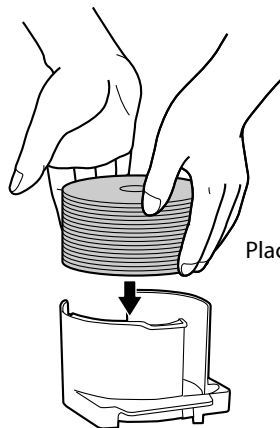

Place the label surface facing upwards.



- Do not load discs above the dotted red line on the stacker. The product may malfunction, or the discs may be damaged.
- Make sure that the bottom of the stacker is not dirty before loading the discs.

The stacker to use as the input stacker differs depending on the product model and the set publish mode. Confirm the input stacker in the following table.

For PP-100III/PP-100AP

Publish Mode	Input Stacker	Number of Discs
Standard Mode	Stacker 1	Up to approximately 50 discs
External Output Mode (Different types of discs can be loaded into Stacker 1 and Stacker 2.)	Stacker 1	Up to approximately 50 discs
	Stacker 2	Up to approximately 50 discs
Batch Mode	Stacker 1	Up to approximately 50 discs
	Stacker 2	Up to approximately 50 discs

For PP-50II

Publish Mode	Input Stacker	Number of Discs
Standard Mode	Stacker 1	Up to approximately 50 discs
Low-volume Mode (Different types of discs can be loaded into Stacker 1 and Stacker 2.)	Stacker 1	Up to approximately 50 discs
	Stacker 2	Up to approximately 50 discs

4 Insert the stacker, and close the disc cover.**For PP-100III/PP-100AP**

- When Stacker 4 is set as the output stacker in Standard mode and External Output mode, remove Stacker 3 and set the lock lever to **UNLOCK**.

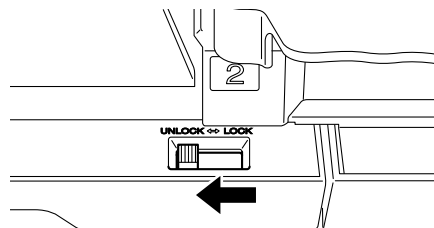

- In Batch Mode and when Stacker 3 is set as the output stacker in External Output Mode, make sure that no discs are loaded in Stacker 3 and Stacker 4. Also, set the lock lever to **LOCK**, and do not pull out Stacker 4.

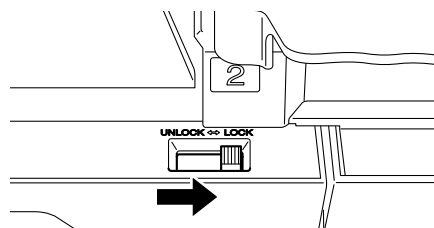

Registering Write Data (Only for PP-100III/PP-50II)

This section describes how to register data to be written in Disc view of EPSON Total Disc Maker.

Notes

- There is no need to register write data if you only want to print disc labels.
- If you directly publish CD/DVD copies from a CD/DVD disc inserted in the drive of your PC, see [“Creating Copies Directly from Discs” on page 76](#) for registering write data.
- If you publish CD/DVD copies using a disc image file, see [“Creating Copies from Disc Image Files” on page 78](#) for registering write data.
- For details on EPSON Total Disc Maker, see EPSON Total Disc Maker Help.

In this example, we explain the procedure to publish photo data CDs.

- 1 Display Disc view of EPSON Total Disc Maker.
See [“Disc view \(only for PP-100III/PP-50II\)” on page 36](#).
- 2 Configure each setting.
See EPSON Total Disc Maker Help for details.

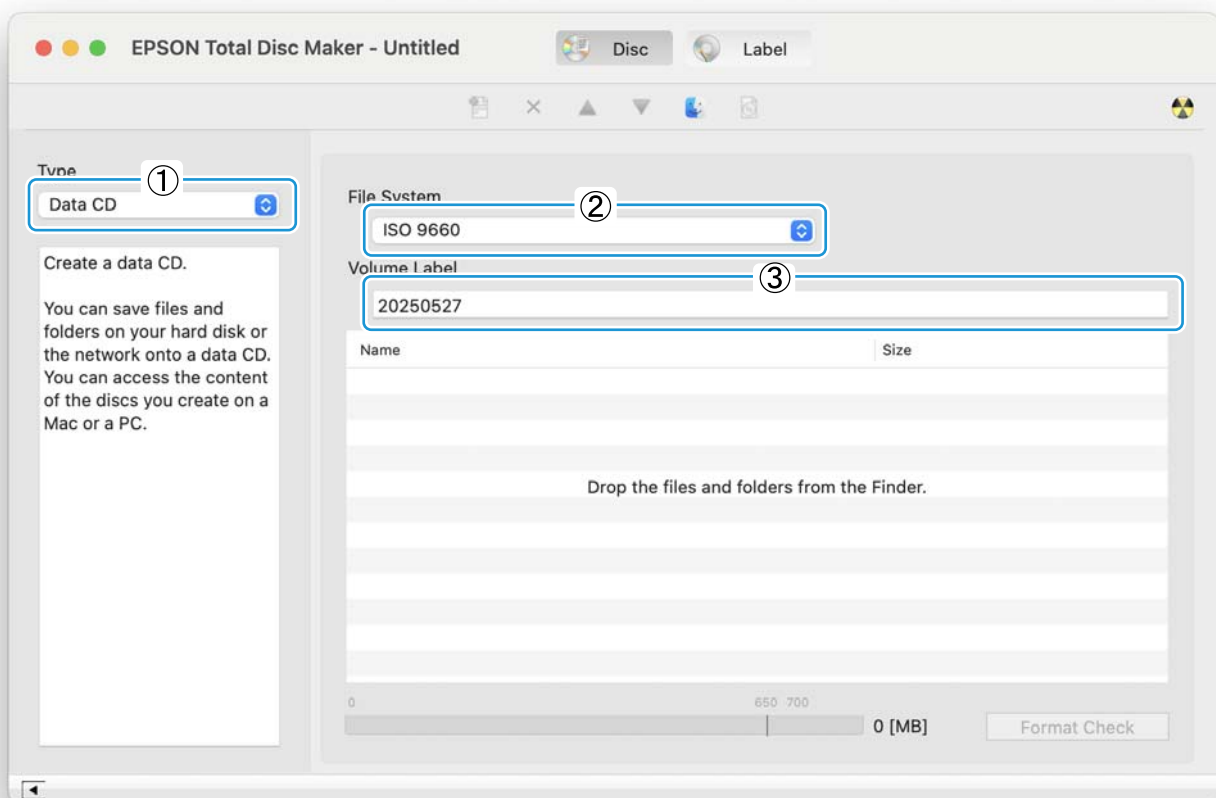

- 3 Click  [Open Finder].

4 Drag and drop any image data to write to the CD from Finder.

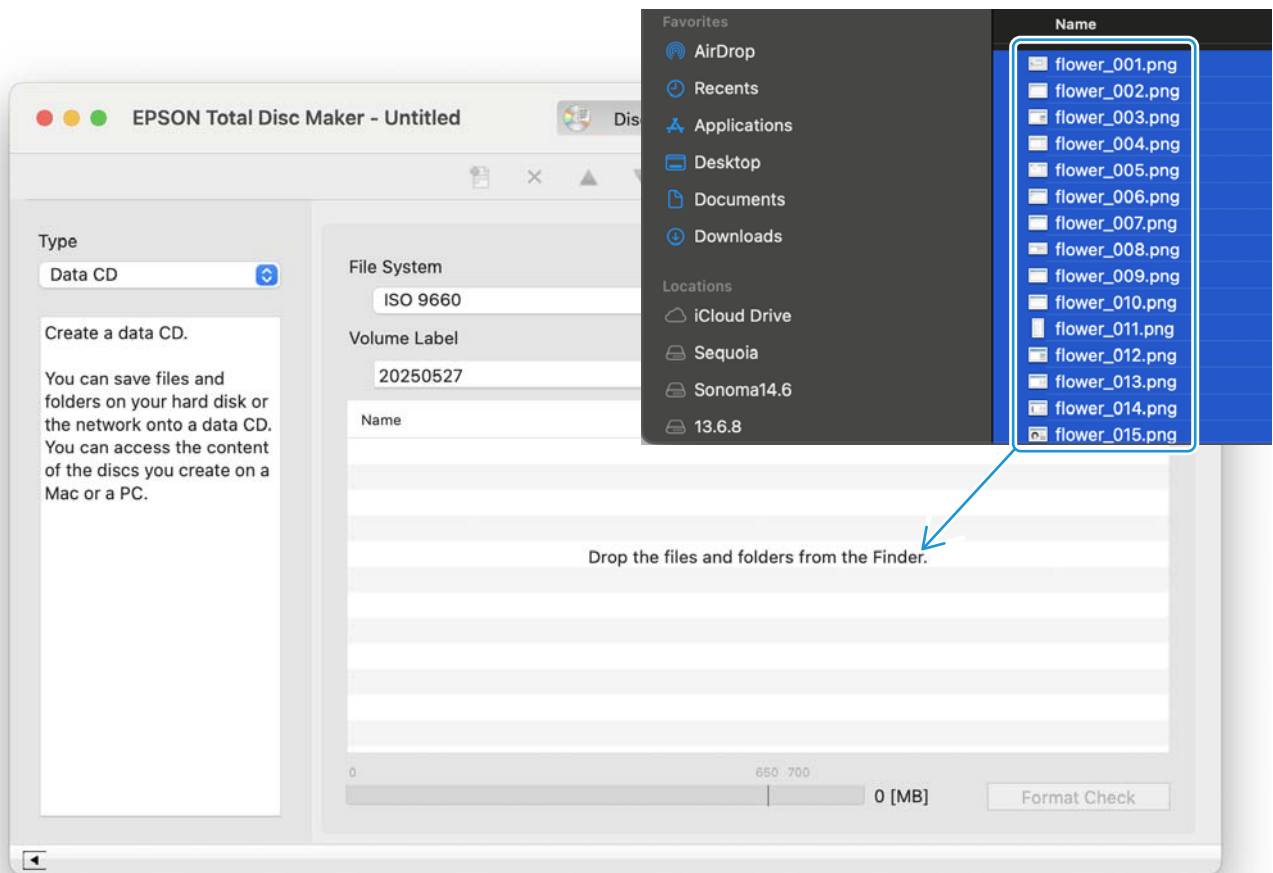

The data that you drag and drop appears in the data list.

Notes

- When the registered data does not comply with the restrictions of the selected file system, the file system restriction dialog box appears. See EPSON Total Disc Maker Help for details on file system restrictions.
- If you select **Create Disc Image...** from the **File** menu after registering the write data, the registered data is saved as a disc image file. A disc image file is used when creating CD/DVD copies of the registered data. See ["Creating Copies from Disc Image Files" on page 78](#) for details.

The registration of write data is now finished.

Creating Labels

Create a label design in Label view (See [“Label view” on page 37.](#)) of EPSON Total Disc Maker.

In the label view, an image of the print results of the label appears. You can edit the label while checking the image of the print results.

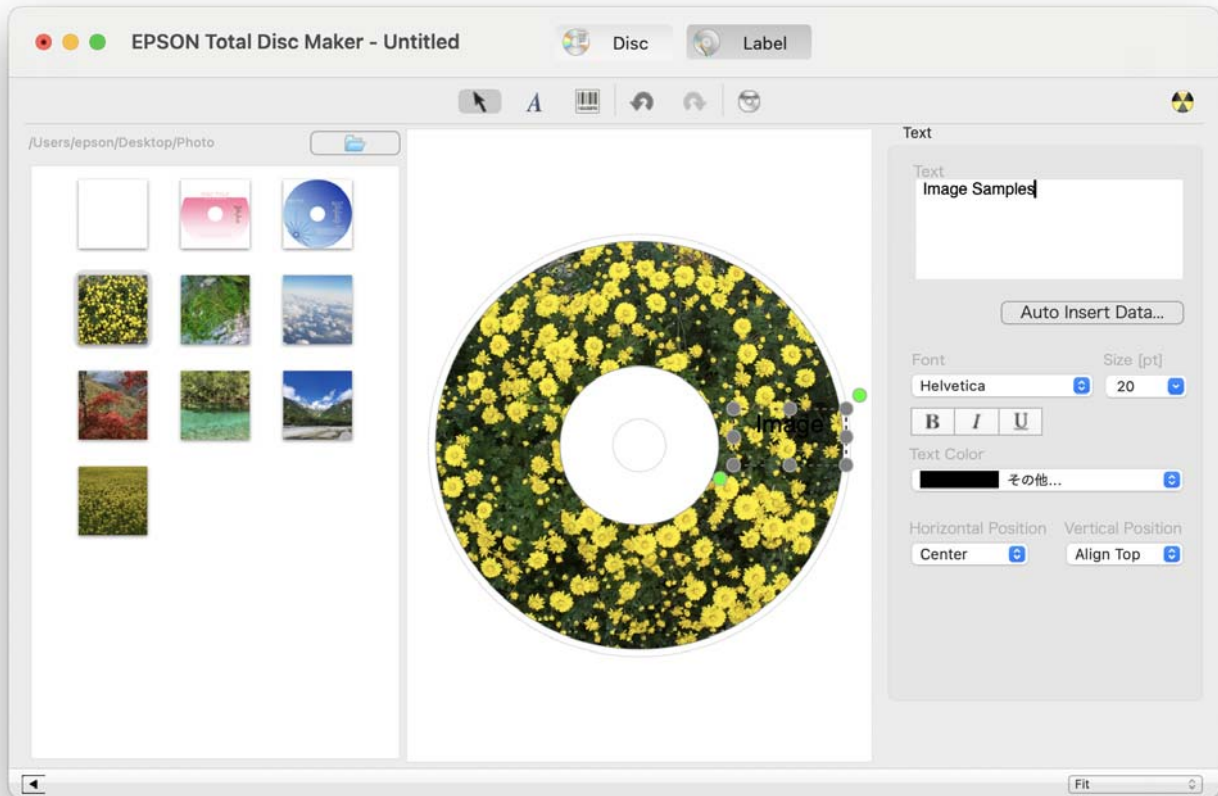

Notes

- There is no need to create a label if you only want to write data to discs.
- For details on EPSON Total Disc Maker, see EPSON Total Disc Maker Help.



- When printing barcodes and 2D codes, be sure to use Epson brand ink cartridges.
- When printing barcodes and 2D codes on discs that are not Epson specified CD/DVDs, check whether the printed barcodes or 2D codes can be read correctly by a scanner.
- Do not place barcodes and 2D codes where they overlap with other print data, or where they extend out of the print area.
- Barcodes and 2D codes use the ratio of black to white to indicate information. If ink penetration results in a deterioration in the ratio of black to white, barcodes and 2D codes may not be able to be read correctly. Check whether the printed barcodes and 2D codes can be read correctly by a scanner.
- If a barcode printed with bidirectional printing cannot be read correctly, align the print head (See [“Aligning the Print Head” on page 90.](#)) and then print the barcode, or print the barcode with unidirectional printing.

Publishing Discs

This section describes how to publish a job for publishing discs to the product in Publish view of EPSON Total Disc Maker.

- 1 Click  [**Publish**] in Disc view or Label view to display Publish view.
- 2 Configure each setting.
See EPSON Total Disc Maker Help for details.

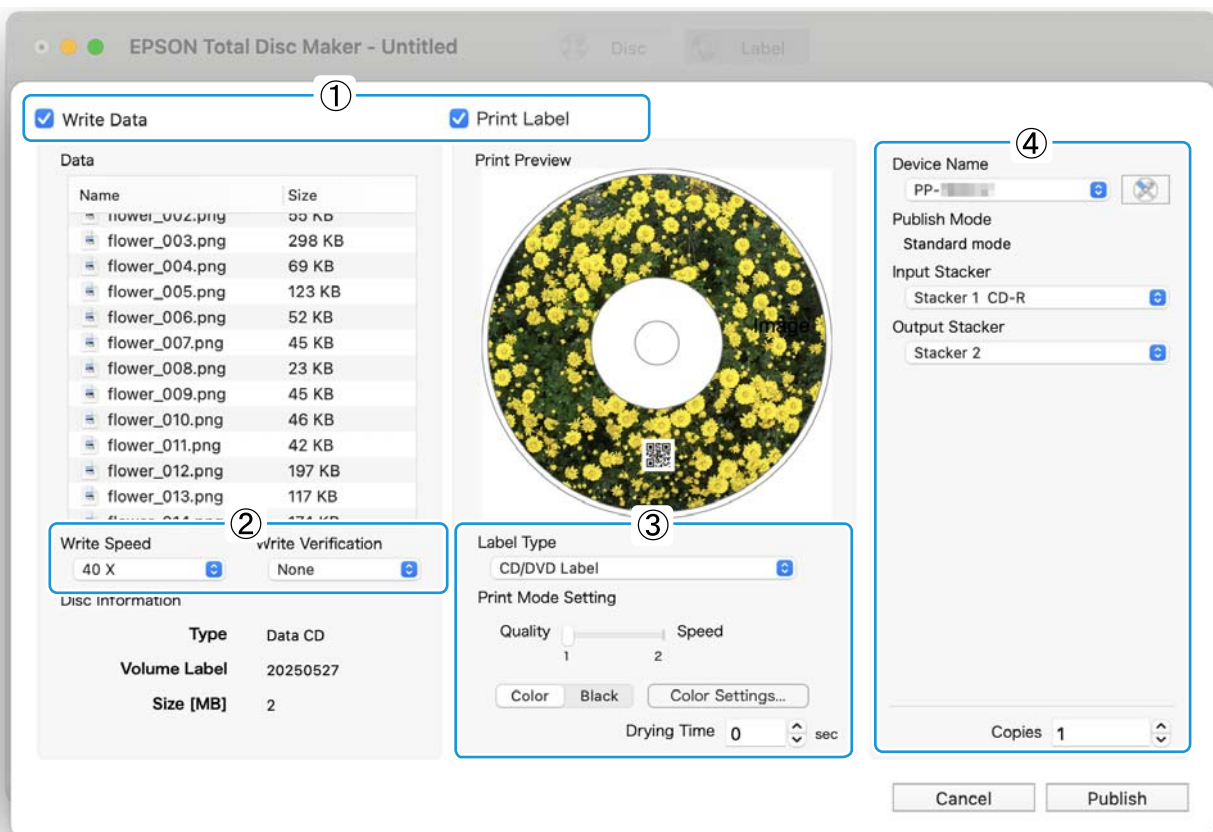

- Depending on the discs and PC used, the writing speed may become slower than the set speed.
- Depending on the discs used, writing may not be able to be performed properly at the speed recommended for the disc. If this happens, write at a slower speed. In particular, we recommend writing to DVD±R DL at a slow speed.
- If you print on the matte label type of Epson specified CDs, set **Label Type** to **CD/DVD Label**.
- If you print on the matte label type of Epson specified DVDs, set **Label Type** to **CD/DVD Premium Label**.
- If **Label Type** is set to **EPSON Specified CD/DVD Label**, **Quality/Speed** is set to **1**.

Notes

- If **Write Verification** is set to **Compare**, you can confirm whether data was written to discs properly.
- Clicking **Color Settings...** allows you to make color adjustments. (See [“Adjusting Print Colors”](#) on page 79.)

3 Make sure that discs are loaded in the input stacker correctly.
See [“Loading Discs”](#) on page 61.

4 Click **Publish**.
EPSON Total Disc Utility starts, and the disc publishing process begins.



- Do not open the disc cover, maintenance box cover (only for the PP-100III/PP-100AP), and ink cartridge cover while a job is being processed (while the **BUSY** light is flashing). This could adversely affect the writing or printing quality.
- If a job is being processed (while the **BUSY** light is flashing) and you need to open the disc cover to load or take out discs, first pause the job and then open the disc cover. See [“Pausing/Cancelling Jobs”](#) on page 73 for the procedure to pause a job.
- If you open the disc cover while a job is being processed (while the **BUSY** light is flashing), an alarm beep sounds and the current job enters the standby status. Closing the disc cover automatically resumes the job.
- While an alarm beep is sounding, the arm is moving. To ensure safety, do not put your hands inside the product. Also, do not operate any stackers while an alarm beep is sounding. This could damage the arm.
- Once the output stacker becomes full, the job is paused. The job is resumed automatically if you take out the published discs and close the disc cover/stacker 4.
- With the PP-100III or PP-100AP, you can take out the published discs output to Stacker 4 without pausing the job. However, when the **BUSY** light is flashing rapidly, do not pull out Stacker 4 because discs are being output to Stacker 4. Doing so may damage the discs.
- If the Mac shuts down while processing a job, all the jobs are cancelled.
- If the Mac is shut down, logged off, or put into sleep mode while registering a job, the job may not be cancelled and may remain. In that case, it will be published when the Mac is started up again or turned back on.

Setting Printer Driver and Publishing Discs

This section describes how to set the printer driver (setting for label print and registering a disc image file of write data*) and publish a job for publishing discs to the product when you publish discs with applications other than EPSON Total Disc Maker.

* Registering write data is not available with the PP-100AP.

In this example, we explain the procedure using Mac Preview.

- 1 Start up Preview.
- 2 Open the data to be printed on the disc label.

Notes

When you print using application other than EPSON Total Disc Maker, create the print data using the following settings.

- Paper size: 124×124 mm
- Top, bottom, left, and right margins: 2 mm.

- 3 Select **Print...** from the **File** menu.
The setting screen of the printer driver appears.

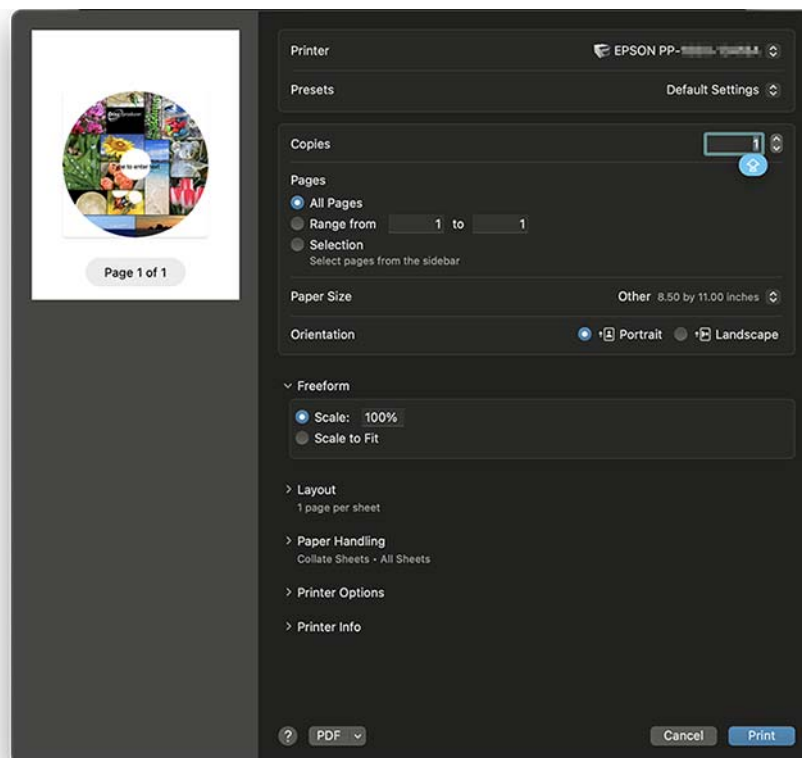

- 4 Set **Printer** to **EPSON PP-xxx-xxxxxx**.
- 5 Set **Paper Size** to **CD/DVD**.

6 Select Print Settings.

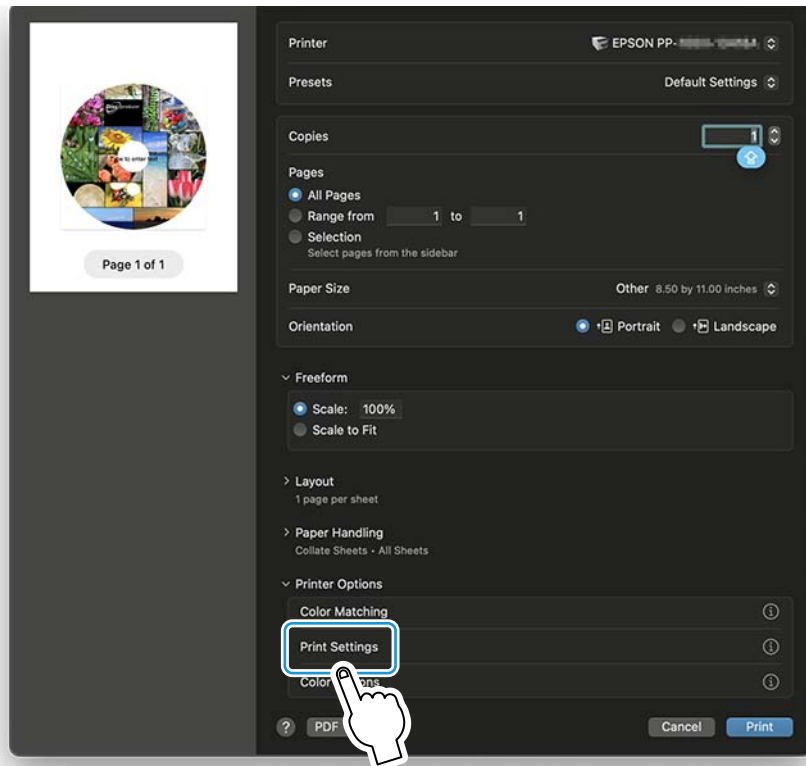

The **Print Setting** area appears.

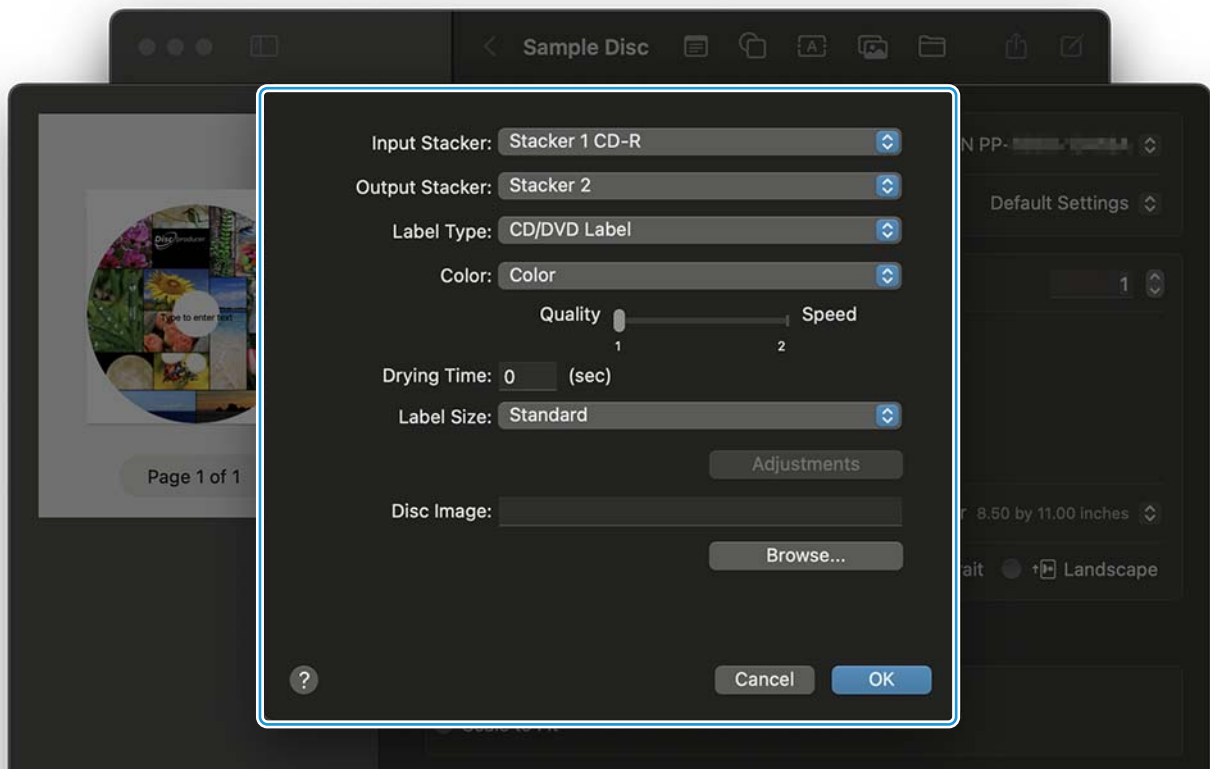

7 Configure each setting.

See [“Print Settings area” on page 46](#) for details.

8 Click **Print**.

EPSON Total Disc Utility starts, and the disc publishing process begins.



- Do not open the disc cover, maintenance box cover (only for the PP-100III/PP-100AP), and ink cartridge cover while a job is being processed (while the **BUSY** light is flashing). This could adversely affect the writing or printing quality.
- If a job is being processed (while the **BUSY** light is flashing) and you need to open the disc cover to load or take out discs, first pause the job and then open the disc cover. See [“Pausing/Cancelling Jobs” on page 73](#) for the procedure to pause a job.
- If you open the disc cover while a job is being processed (while the **BUSY** light is flashing), an alarm beep sounds and the current job enters the standby status. Closing the disc cover automatically resumes the job.
- While an alarm beep is sounding, the arm is moving. To ensure safety, do not put your hands inside the product. Also, do not operate any stackers while an alarm beep is sounding. This could damage the arm.
- Once the output stacker becomes full, the job is paused. The job is resumed automatically if you take out the published discs and close the disc cover/stacker 4.
- With the PP-100III or PP-100AP, you can take out the published discs output to Stacker 4 without pausing the job. However, when the **BUSY** light is flashing rapidly, do not pull out Stacker 4 because discs are being output to Stacker 4. Doing so may damage the discs.
- If the Mac shuts down while processing a job, all the jobs are cancelled.

Taking out discs

When the publishing process finishes, follow the steps below to take out published discs.

For PP-100III/PP-100AP

The stacker used as the output stacker differs depending on the publish mode. Confirm the output stacker in the following table.

Publish Mode	Output Stacker	Number of Discs
Standard mode (when the output stacker is set to Stacker 2)	Stacker 2	Up to approximately 50 discs
Standard mode (when the output stacker is set to Stacker 4)	Stacker 4	Up to approximately 5 discs
External Output mode (when the output stacker is set to Stacker 3)	Stacker 3	Up to approximately 50 discs
External Output mode (when the output stacker is set to Stacker 4)	Stacker 4	Up to approximately 5 discs
Batch mode	Stacker 2	Up to approximately 50 discs
	Stacker 3	Up to approximately 50 discs

- 1 Only when the output stacker is Stacker 2 or Stacker 3, open the disc cover and take it out.
For precautions when you open the disc cover, see [“Opening the Disc Cover”](#) on page 21.
- 2 Take out the published discs from the stacker.

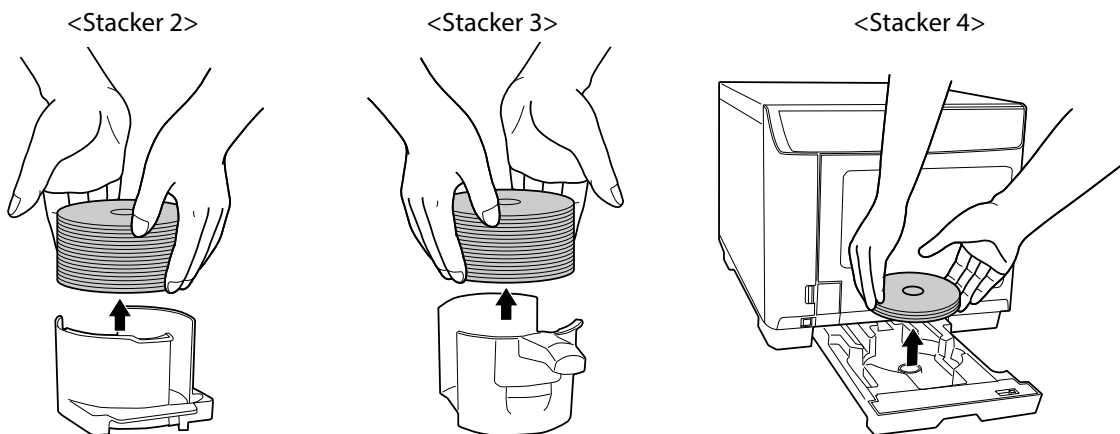

- After printing on the label surface, allow Epson specified CDs/DVDs to dry for at least one hour, and other types of discs for at least 24 hours. Do not insert discs into a drive or other device until they are completely dry.
- Avoid drying under direct sunlight.
- Directly touching or moisture getting on the label surface before or after printing may result in blurring or discs sticking together.

For PP-50II

The stacker used as the output stacker differs depending on the publish mode. Confirm the output stacker in the following table.

Publish Mode	Output Stacker	Number of Discs
Standard mode (when the output stacker is set to Stacker 2)	Stacker 2	Up to approximately 50 discs
Standard mode (when the output stacker is set to Stacker 3)	Stacker 3	Up to approximately 20 discs
Low-volume mode	Stacker 3	Up to approximately 20 discs

- 1** Open the disc cover.
For precautions when you open the disc cover, see [“Opening the Disc Cover”](#) on page 21.
- 2** Only when the output stacker is Stacker 2, take it out.
- 3** Take out the published discs from the output stacker.

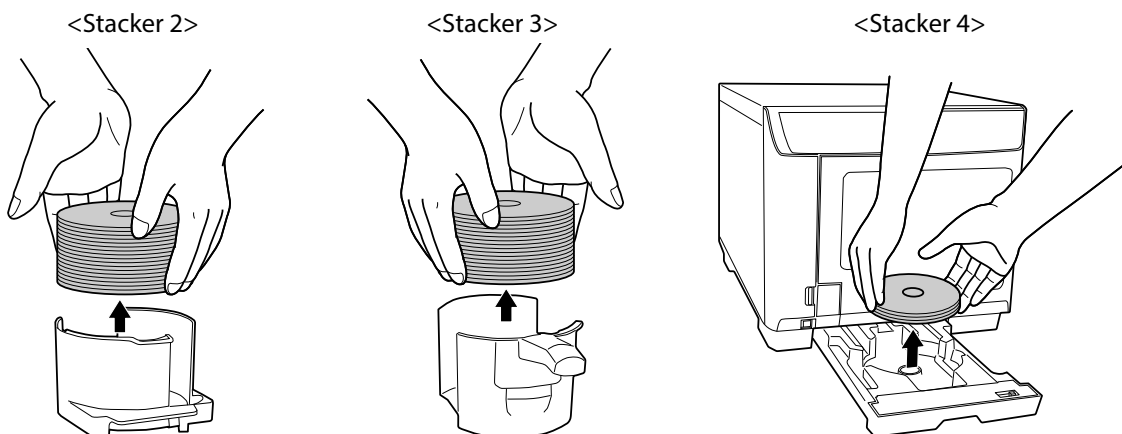

- After printing on the label surface, allow Epson specified CDs/DVDs to dry for at least one hour, and other types of discs for at least 24 hours. Do not insert discs into a drive or other device until they are completely dry.
- Avoid drying under direct sunlight.
- Directly touching or moisture getting on the label surface before or after printing may result in blurring or discs sticking together.



Job Operations

Processing performed by this product, such as writing and printing data, is called a “job.”

After publishing a job with EPSON Total Disc Maker or the printer driver, you can pause/cancel it or change the processing order of jobs.

Pausing/Cancelling Jobs

Follow the steps below to pause or cancel a job.

- 1 Start up EPSON Total Disc Utility.
See “Starting EPSON Total Disc Utility” on page 39.
- 2 Select the job for which you want to pause/cancel processing, and click  [Pause]/  [Cancel].

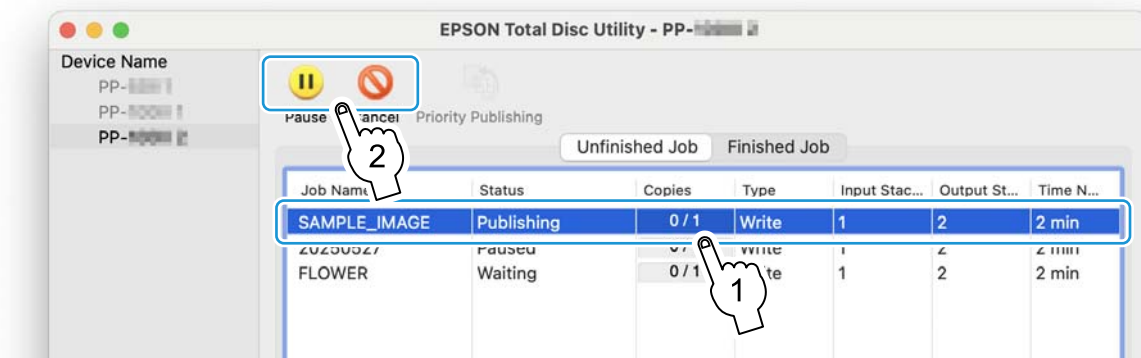

When the job is paused, the job status display changes to **Paused**.

When the job is cancelled, the job display disappears from the **Unfinished Job** screen.



- If a job is paused when there is a disc being published, the job is paused after the processing is finished.
- The processing of any subsequent job also does not start while the job is paused.
- If a job is cancelled when the disc is being published, that processing is stopped, and the disc is output to the output stacker.

Notes

Selecting a paused job and clicking  [Resume] /  [Cancel] allows you to resume or cancel the job.

Priority Publishing

If you need to process a job before the others when more than one job is being published, follow the steps below.

- 1 Start up EPSON Total Disc Utility.
See “Starting EPSON Total Disc Utility” on page 39.
- 2 Select the job you want to give priority to, and click  [Priority Publishing].

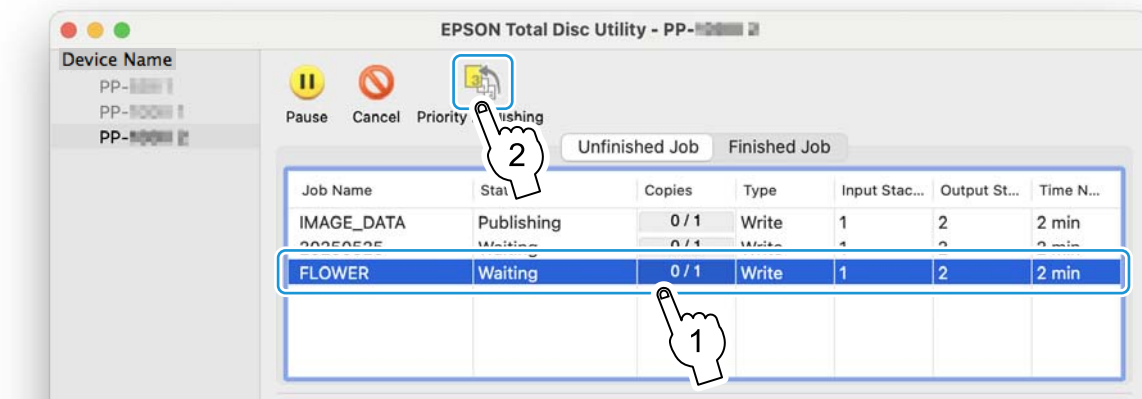

The selected job will be processed after the job in progress.

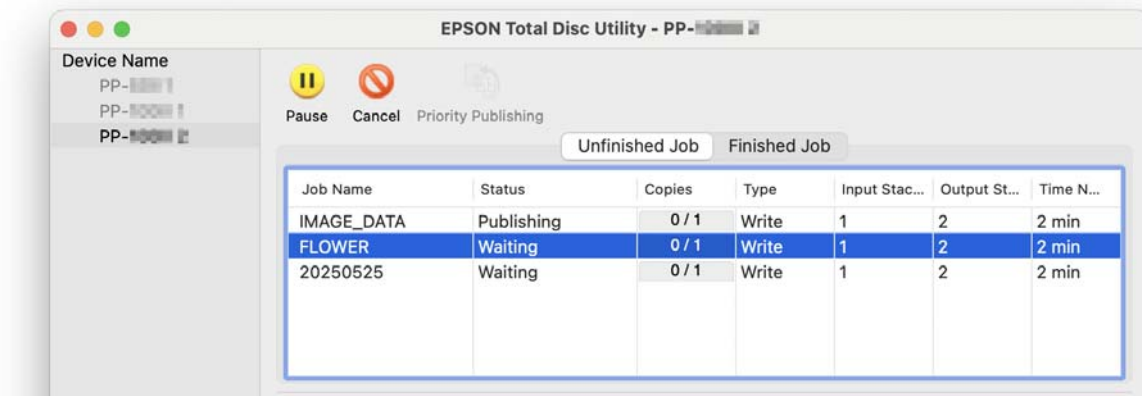

Notes

No job can be given priority before such operations as nozzle checking, aligning print head, and correcting printing position.

Convenient Features

Printing on User Defined Label Size Discs

Set an arbitrary size if you print on discs whose label size is other than **Standard** and **Wide**.

Setting item	Description
Inside Diameter	Set the inside diameter of the label. You can set a value within the range of 1.80 to 5.00 cm (180 to 500).
Outside Diameter	Set the outside diameter of the label. You can set a value within the range of 7.00 to 11.94 cm (700 to 1194).
Mask Rib Area	Check this to mask the rib area. Rib refers to the protruding section of the disc inside circumference. Masking the rib area enables you to prevent ink running onto the rib when a printed disc and rib touch in the output stacker.
Rib Inside Diameter	Set the inside diameter of the rib area. You can set a value within the range of 2.70 to 5.00 cm (270 to 500).
Rib Width	Set the width of the rib area. You can set a value within the range of 0.01 to 1.15 cm (1 to 115).



Printing inside the rib area may result in ink getting on discs, discs sticking together, or discoloration.

Notes

Setting the range outside of the recommended print area (inside diameter of 45.0 mm or more and outside diameter within 116.0 mm) and printing may result in the discs or tray becoming dirty, peeling off or blurring of the print, or discs sticking together. Check the label print range of the discs you are using before configuring the setting. See ["Printable Area" on page 53](#) for details on the recommended print area.

The setting procedure of the user defined label size differs, depending on whether you publish with EPSON Total Disc Maker or with the other applications.

When publishing with EPSON Total Disc Maker

Set in the dialogue that is displayed when you click  [Set Inner/Outer Diameter] in Label view of EPSON Total Disc Maker.

When publishing with the other applications

Set in the dialogue that is displayed when you set **Label Size** to **User Defined**, and then click **Adjustments** in the **Print Settings** area of the printer driver.

Creating Disc Copies (Only for PP-100III/PP-50II)

With EPSON Total Disc Maker, you can create CD/DVD copies using an original disc or a disc image file.

Notes

- This section describes only the procedure to register write data to create disc copies. For the procedures other than registering write data, follow the usual flow. (See [“Flow for Publishing Discs” on page 55.](#))
- If you publish with applications other than EPSON Total Disc Maker, specifying an image file in the print setting of the printer driver allows you to create disc copies. (See [“Print Settings area” on page 46.](#))

Creating Copies Directly from Discs

This section describes how to create CD/DVD copies directly from a CD/DVD disc inserted in the drive of your PC.



- As the copy source, use a CD/DVD drive with support for commands compliant with MMC4, and capable of operations compliant with MMC4.
- CD/DVD copies may not be able to be created depending on the model of CD/DVD drive used as the source. In such a case, try changing the source CD/DVD drive.
- Copying is not possible if the source disc is a multi-session CD/DVD.
- Copying is not possible if the source disc is a packet-written CD.

- 1 Insert the disc you want to create a copy of in the drive of the PC.

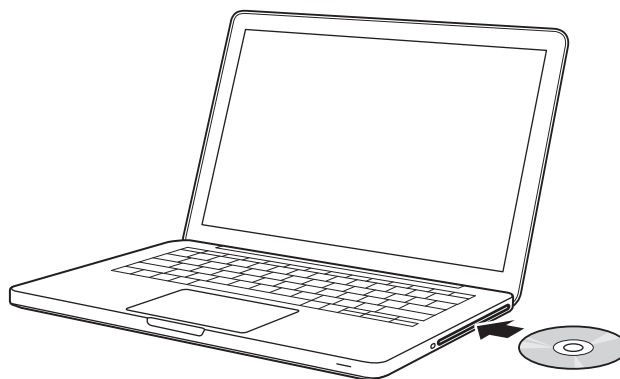

- 2 Start up EPSON Total Disc Maker.
See [“Starting EPSON Total Disc Maker” on page 35.](#)

- 3** Configure each setting.
See EPSON Total Disc Maker Help for details.

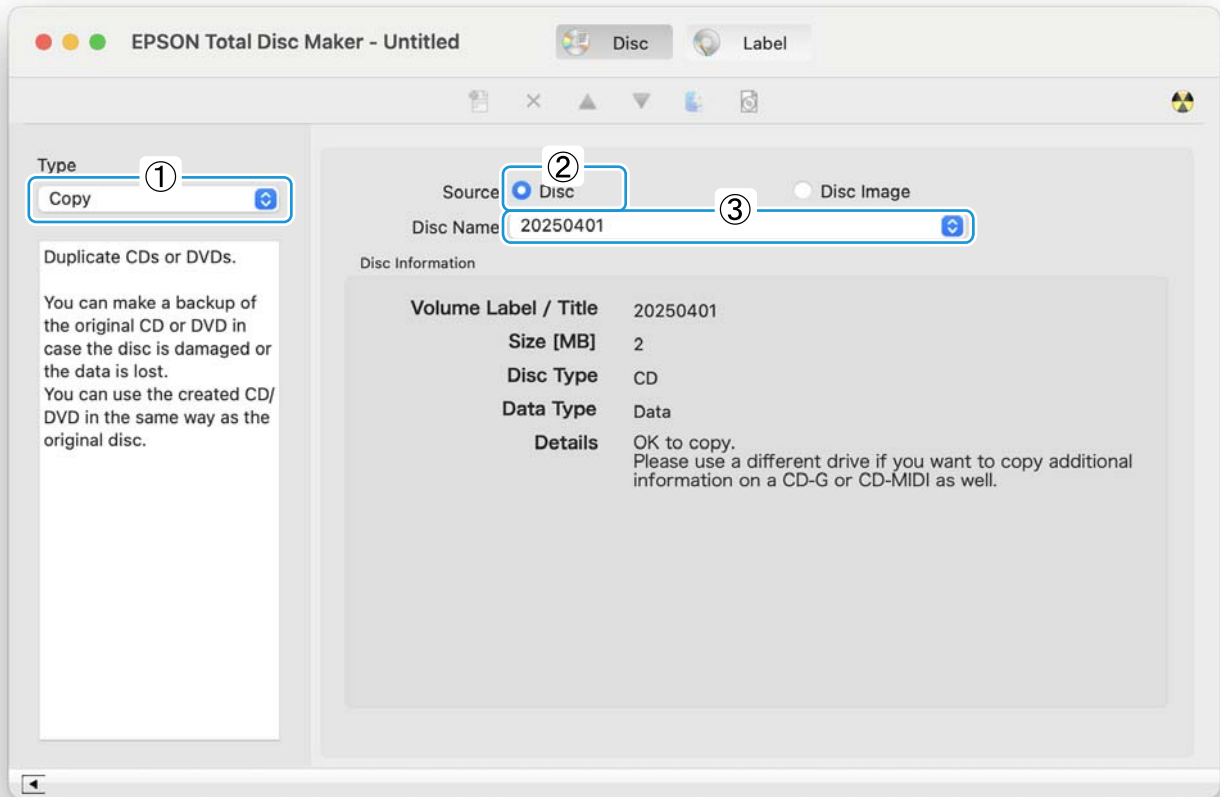

The registration of write data is now finished.

Creating Copies from Disc Image Files

This section describes how to create CD/DVD copies using a disc image file.

Notes

If you click **Create Disc Image...** on the **File** menu after registering write data (see [page 63.](#)), you can create a disc image file.

- 1 Start EPSON Total Disc Maker.
See “Starting EPSON Total Disc Maker” on page 35.
- 2 Set **Type** to **Copy**.
- 3 Configure each setting.
See EPSON Total Disc Maker Help for details.

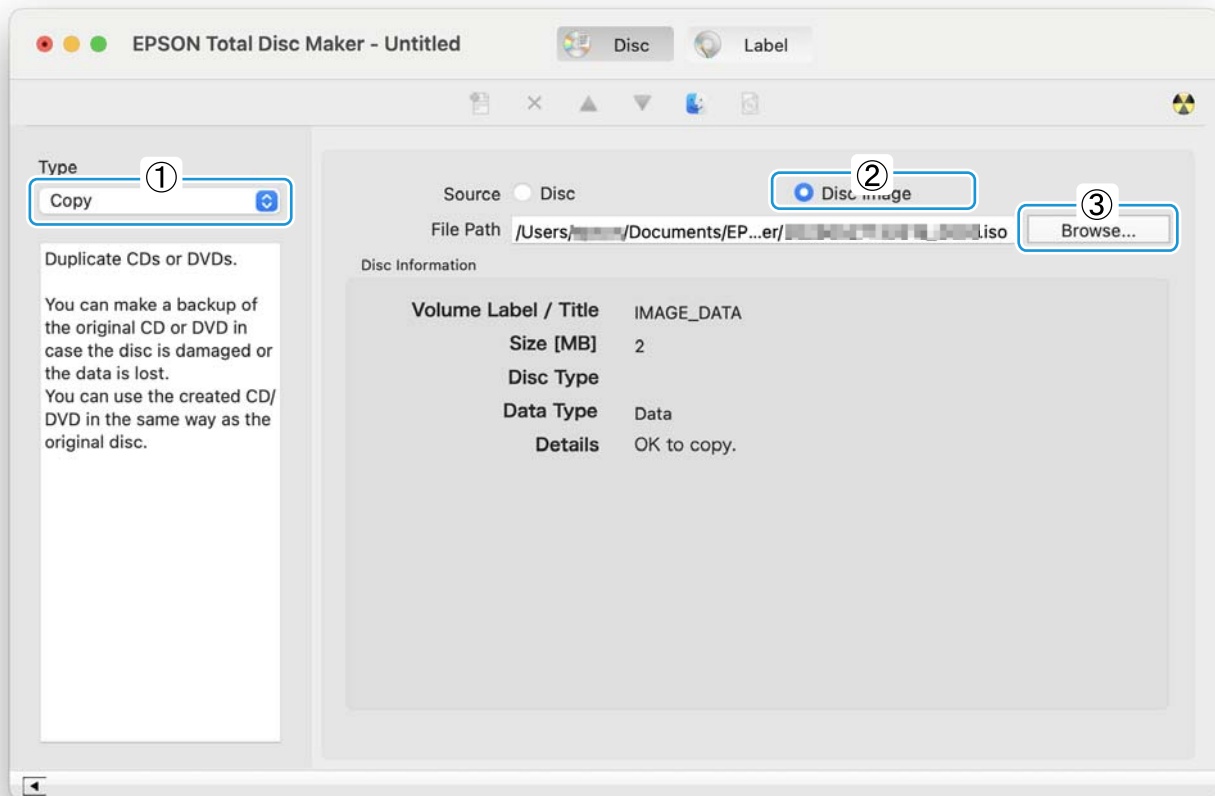

The registration of write data is now finished.

Adjusting Print Colors

This section describes how to adjust the colors of print data.

Notes	If you wish, you can make color adjustments at the time of printing without making color adjustments to the actual data.
--------------	--

Mode	Photo-realistic	Uses the standard color correction of the printer driver for printing.
	Vivid	Performs color processing to increase color saturation to strengthen the intensity of colors.
	EPSON Standard	Performs color processing to obtain the standard colors of Epson.
	Adobe RGB	Performs color processing with Adobe RGB for wider color space. Select this option when, for example, printing print data that includes Adobe RGB color space information.
Gamma	1.5	Produces a softer image than one printed using a gamma value of 1.8.
	1.8	Produces a print with more depth and crispness than one printed using a gamma value of 1.5. Use this value for normal printing.
	2.2	Use this value when printing to match color with a device that uses sRGB.
Adjustments	Brightness	Allows you to use a slider to adjust the overall brightness of an image. With 0 as the standard, you can adjust the brightness from - 25% to + 25%. Moving the slider in the negative direction (-) makes the image darker, and moving the slider in the positive direction (+) makes the image brighter. This is useful for images that are too dark or too light overall.
	Contrast	Allows you to use a slider to adjust the contrast between light and dark in an image. With 0 as the standard, you can adjust the contrast from - 25% to + 25%. When you increase the contrast, the bright areas become brighter and the dark areas become darker. Conversely, if you decrease the contrast, the difference between light and dark in the image decreases.
	Saturation	Allows you to use a slider to adjust the saturation (vividness of the colors) of an image. With 0 as the standard, you can adjust the brightness from - 25% to + 25%. When you increase the saturation, the colors become stronger. When you decrease the saturation, colors are lost and the image becomes colorless and close to gray.
	Cyan	- setting: Strengthens red. + setting: Strengthens cyan.
	Magenta	- setting: Strengthens green. + setting: Strengthens magenta.
	Yellow	- setting: Strengthens blue. + setting: Strengthens yellow.

The adjusting procedure differs, depending on whether you publish with EPSON Total Disc Maker or with other applications.

When publishing with EPSON Total Disc Maker

Set in the dialogue that is displayed when you click **Color Settings...** in Publish view of EPSON Total Disc Maker. Click **Color Correction** to configure each setting.

Notes

- If you set **Print Mode Setting** to **Black** in Publish view of EPSON Total Disc Maker, you can adjust only **Gamma**, **Brightness**, and **Contrast**.
- Select **ColorSync** when adjusting colors between devices. If you select **ColorSync**, color adjustment is not possible.

When publishing with other applications

Select **Color Correction** in the **Color Options** area of the printer driver to set **Mode** and **Gamma**. Click **Adjustments** to set the rest of the items.

Notes

If you set **Color** to **Black** in the **Print Settings** area, you can adjust only **Gamma**, **Brightness**, and **Contrast**.

Maintenance

Replacing the Ink Cartridge

Checking the Ink Levels

When it becomes time to replace even one of the six ink cartridges, printing is no longer possible. The **INK** light on the control panel notifies you the ink levels as follows.

- When the **INK** light flashes, the remaining ink of that color is low. Prepare a new ink cartridge. You can continue printing labels until the **INK** light turns on.
- When the **INK** light turns on, it is time to replace the ink cartridge of that color. Replace it with a new ink cartridge.

INK lights on the Control panel

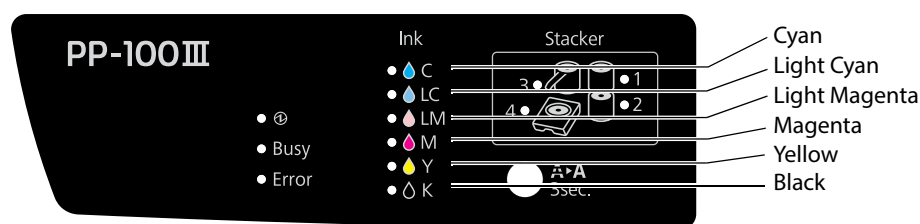

You can check the ink levels in EPSON Total Disc Utility. See EPSON Total Utility Help for details.

Notes

- When the ink cartridges are installed for the first time (during setup), ink is consumed for filling, and so the time to replace the cartridges is earlier than normal.
- Even when **Print Mode Setting** is set to **Black** in Publish view of EPSON Total Disc Maker or when **Color** is set to **Black** in the **Print Settings** area of the printer driver, all the ink colors are used in an operation designed to maintain the printing and print head quality.
- The product stops running before the ink is completely empty to maintain print head quality. Therefore, some ink remains in the ink cartridge.

How to Replace the Ink Cartridges

This section describes how to replace the ink cartridges, using light magenta as an example. The replacement positions differ for the other colors, but the procedure is the same.

See “[Ink cartridges and Maintenance Box](#)” on page 154 for the ink cartridge model numbers.



- Use of Epson brand ink cartridges is recommended. Use of non-Epson brand ink cartridges can result in problems that will not be covered by the warranty.
- Epson cannot guarantee the quality and reliability of non-Epson brand products. Repairs for any damage or breakdown of this product due to the use of non-Epson brand products will not be free of charge even if the warranty period is still valid.
- This product performs color adjustment based on use of Epson brand ink cartridges. Use of non-Epson brand ink products can adversely affect the printing quality and prevent the product from realizing its maximum performance.
- Do not place an ink cartridge with the ink supply holes facing downward. This could cause stains on a desk or other surface. In addition, dirt stuck on this product may prevent it from functioning properly.
- Do not store ink cartridges in environments exposed to high temperatures, freezing or direct sunlight.

- 1 Open the ink cartridge cover, and wait at least 4 seconds until internal operations stop.

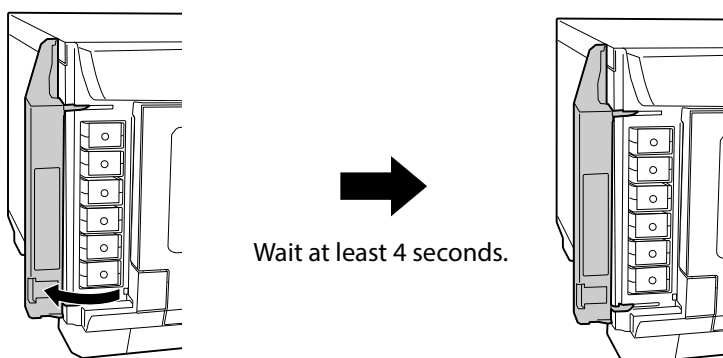

If you take out the ink in less than 4 seconds, there is a risk that the ink may spurt out.

- 2** Gently push in the ink cartridge until you hear a click, unlock the lock, and then slowly pull it straight out.

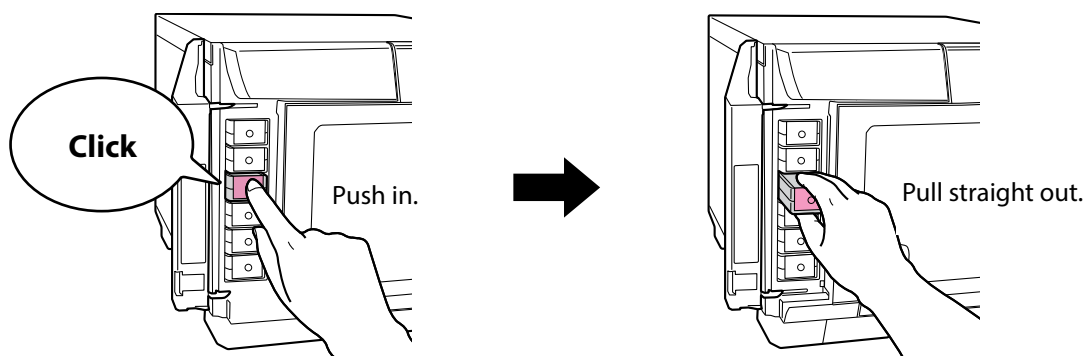

- Ink may leak from the ink supply port on the ink cartridge you pulled out.
- Once an ink cartridge is used, there may be some ink around the ink supply port, so do not touch it.

- 3** Take the ink cartridge out of its package.



- For optimum printing quality, open the clear plastic package only immediately before installing. After opening the cartridge, try to use it up within six months. If you use an ink cartridge that has been left open for a long time, the print quality may decline.
- When you open the plastic package, be careful not to drop the ink cartridge. The ink may leak out.
- Do not leave the ink supply port on an ink cartridge facing downward. This could stain the desk or other surface. In addition, dirt stuck on this product may prevent it from functioning properly.
- Do not shake the ink cartridge too hard. The ink cartridge may leak if you shake it too much.
- Do not touch the green IC chip attached to the ink cartridge. Also, never peel off the labels and film attached to the ink cartridge. This could prevent you from properly setting, operating, or printing with the ink cartridge, or ink could leak out.

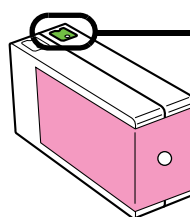

Do not touch the IC chip.

- Use up the ink cartridge before the expiration date printed on the box.

- 4** Use the label color to check where to set the ink cartridge, and gently push the new ink cartridge into the ink cartridge holder on this product until you hear a click.

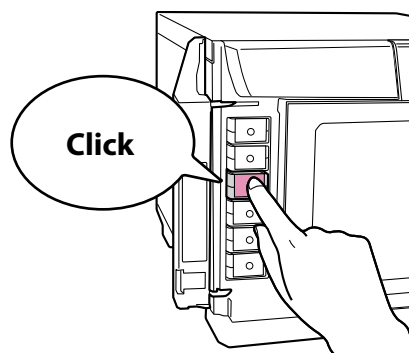

Do not repeatedly take out and put in an ink cartridge which has been set. Ink could stain the ink cartridge or the product.

- 5** Close the ink cartridge cover.

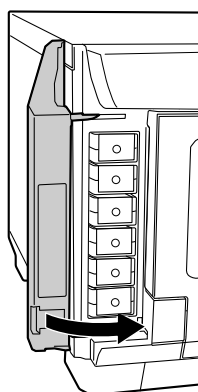

- Do not turn off the power or open the ink cartridge cover during ink charging. These actions cause the ink to be charged again, which results in a noticeable consumption of ink. In addition, there is a risk that you will not be able to print properly.
- If the ink cartridges are not recognized even though they are set properly, dirt may be stuck on the green IC chip surface. Wipe it off with a soft cloth, and then set it again.
- If you cannot print even though the ink cartridges are set properly, run print head cleaning. (See ["Cleaning the Print Head" on page 87.](#))
- If you turn the power off using the power button on the unit, the print head is automatically capped, which prevents the ink from drying. After installing the ink cartridges, be sure to turn the power off using the power button on the unit when you are not using the product. Do not pull out the power plug or trip the breaker while the power is on.
- If you move or transport this product after you have installed the ink cartridges, leave the ink cartridges as they are when you move or transport it.
- Do not take out the ink cartridges unless you are replacing them.

Checking the Print Head Nozzles

If the print head nozzles are clogged, the printing may be faint even though there is ink, or unusual colors may be printed. The nozzle check prints a pattern for checking the status of the nozzles, and you can check if the nozzles are clogged by looking at this pattern.

How to Perform a Nozzle Check

- 1 Set one unprinted disc into Stacker 1.
- 2 Display the **Printer Utility** screen of the EPSON Total Disc Utility.
See “[Properties screen \(General screen\)](#)” on page 41 for display procedure.
- 3 Click **Nozzle Check**.

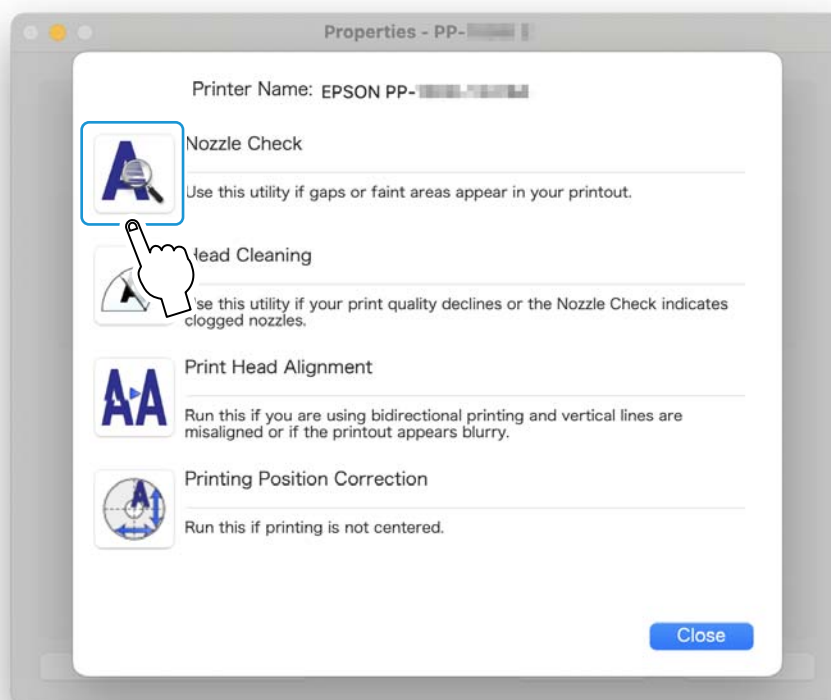

4 Click Print.

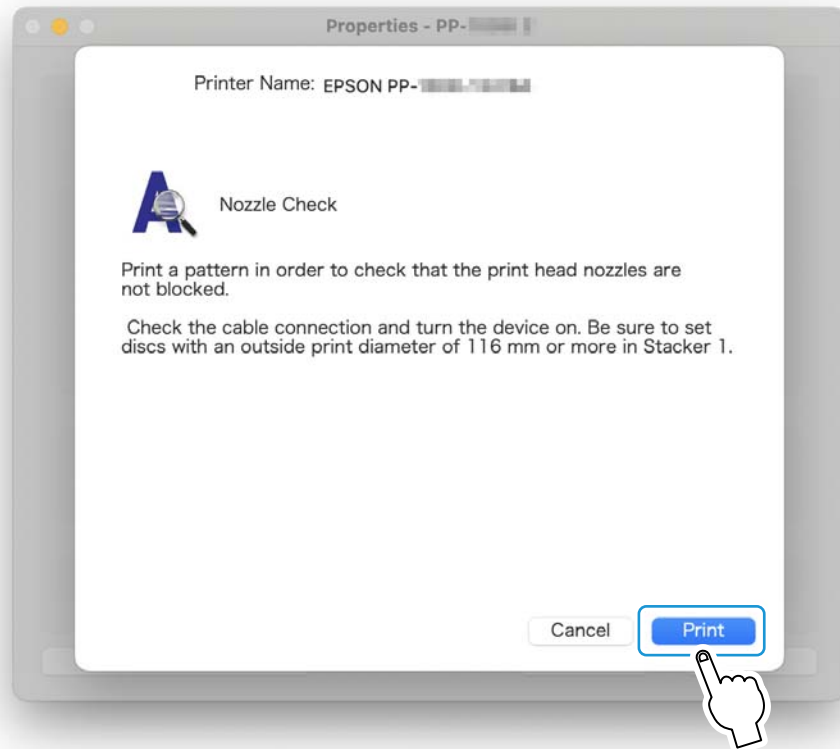

The disc on which the nozzle check pattern was printed is output to Stacker 3 or Stacker 4.

5 Check the printed nozzle check pattern.

If it is normal, all of the lines are printed as shown in the illustration on the left below.

If there are lines that were not printed, as shown in the illustration on the right below, the nozzles are clogged.

Run print head cleaning. (See [“How to Clean the Print Head”](#) on page 88.)

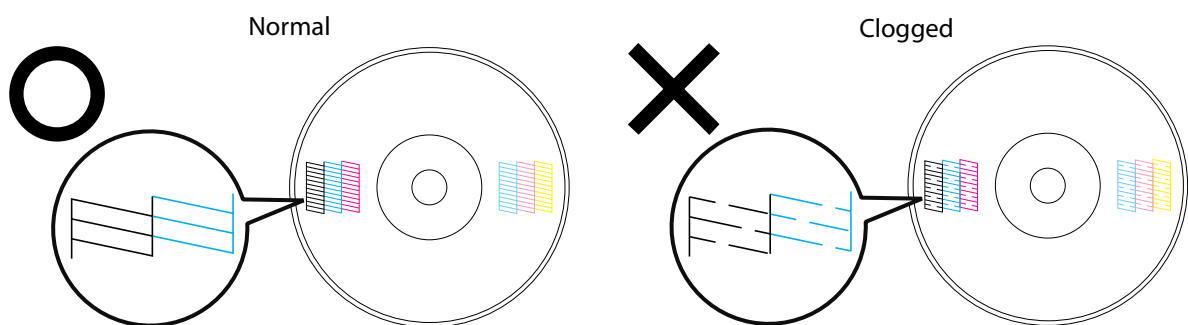

Cleaning the Print Head

Head cleaning is a function for cleaning the surface of the print head to maintain the print quality. Run head cleaning if the printing becomes faint or gaps appear in the printing.

Notes

Print head cleaning consumes ink. Before running print head cleaning, you can run a nozzle check to check whether or not the nozzles are clogged. This makes it possible to prevent consuming extra ink during print head cleaning. (See ["Checking the Print Head Nozzles" on page 85.](#))

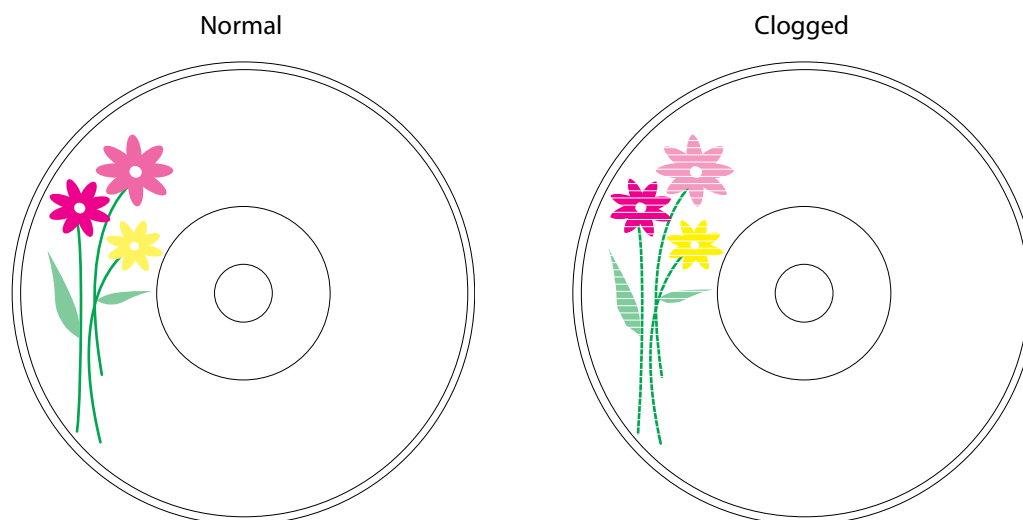

Causes and Solutions for Print Head Drying	
Cause	Prevention
This product has a print head cap to prevent it from drying, the same way there are caps for fountain pens or ballpoint pens. Normally, the print head is automatically capped after printing finishes, but if the power suddenly goes off while the product is running, it is not capped properly and it dries out.	<ul style="list-style-type: none"> Plug the power plug into an outlet directly attached to the wall. Do not connect it to a power strip with a switch. Be sure to turn the power on and off using the power button.
If you do not use this product for a long time, the print head may dry out and become clogged, the same way a fountain pen dries up and no longer writes if it has been left open for a long time.	We recommend that you print regularly. You can maintain the print head in optimal condition by printing regularly.
If you take the ink cartridges out and leave them out, the print head dries out.	Do not take out the ink cartridges and leave them out.

How to Clean the Print Head

There are the following two ways to run head cleaning.

- Running it using the control panel on the product
- Running it from a PC



- Print head cleaning consumes ink. Note that if you run head cleaning more than necessary, the lifetime of the ink cartridges is reduced.
- Do not open the ink cartridge cover while cleaning the print head. Print head cleaning stops if the cover is opened.
- If there is a job being published, head cleaning starts after processing of the job is finished.

Running it using the control panel on the product

- 1 Turn the product on.
- 2 Press the Cleaning button for 3 seconds.
The **BUSY** light flashes, and head cleaning starts.
When head cleaning is finished, the **BUSY** light goes off.

Running it from a PC

- 1 Display the **Printer Utility** screen of the EPSON Total Disc Utility.
See “[Properties screen \(General screen\)](#)” on page 41 for display procedure.
- 2 Click **Head Cleaning**.

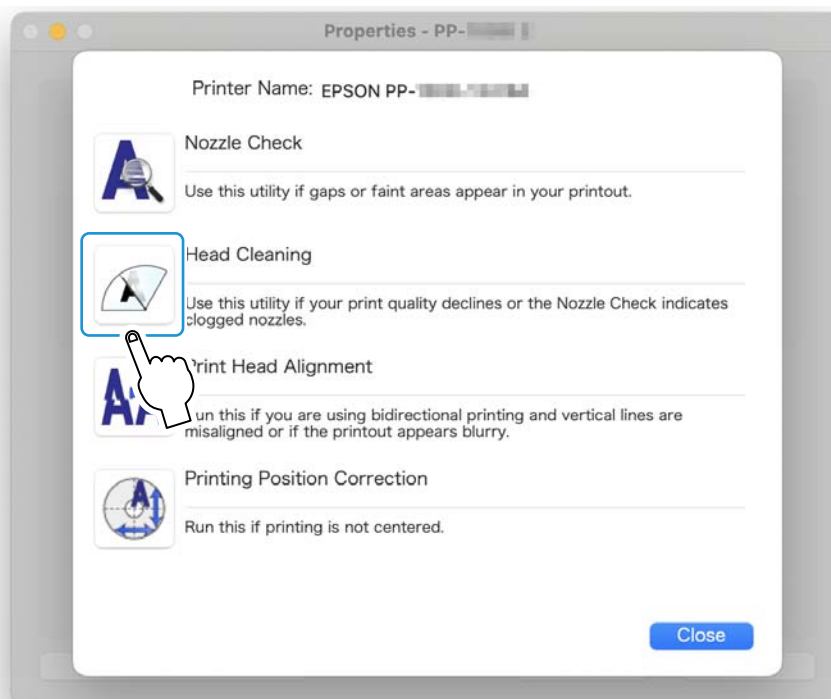

3 Click **Start**.

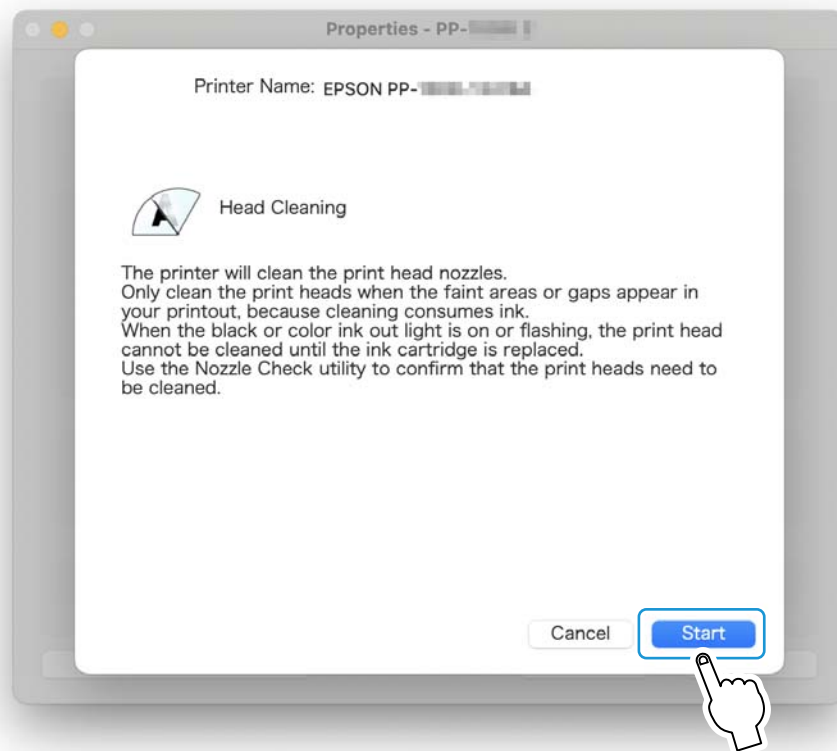

The **BUSY** light flashes, and head cleaning starts.
When head cleaning is finished, the **BUSY** light goes off.

Aligning the Print Head

If the print position when the print head moves from right to left is not aligned with the print position when the print head moves from left to right, gaps may appear in vertical lines, and the print results may become blurry. If this happens, run print head alignment.

- 1 Set one unprinted disc into Stacker 1.
- 2 Display the **Printer Utility** screen of the EPSON Total Disc Utility.
See “[Properties screen \(General screen\)](#)” on page 41 for display procedure.
- 3 Click **Print Head Alignment**.

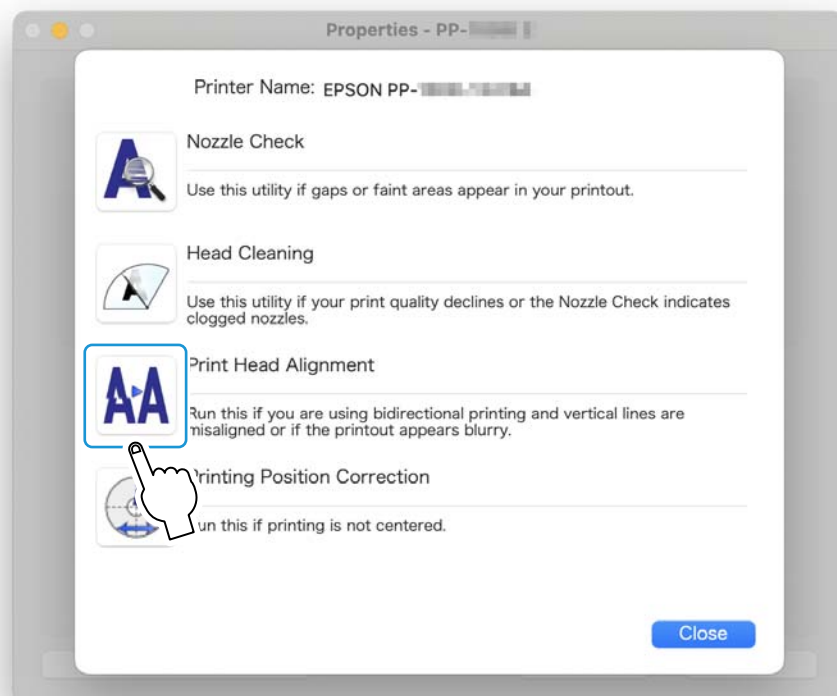

4 Click **Print**.

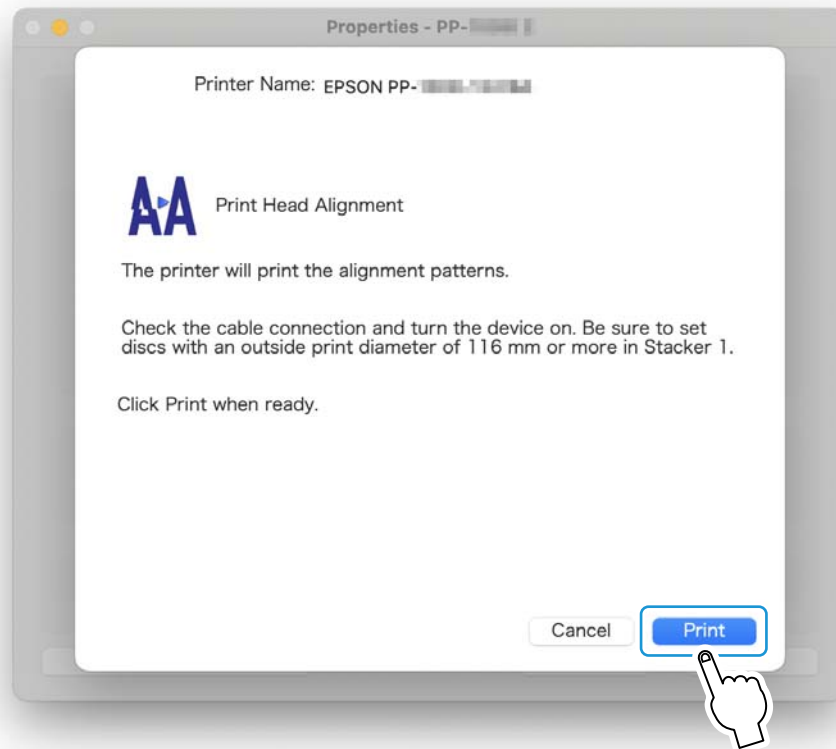

The disc on which the print head alignment pattern was printed is output to Stacker 3 or Stacker 4.

5 Check the printed print head alignment pattern.

Print head alignment pattern

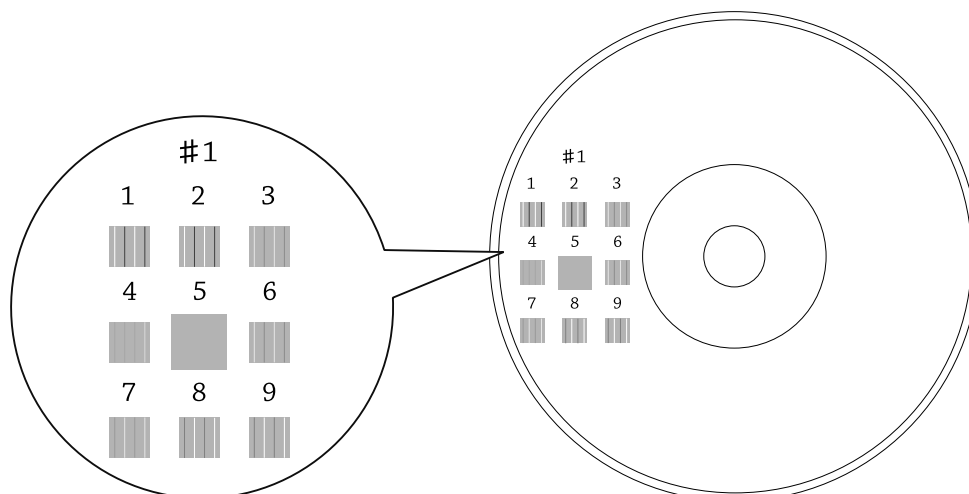

6 Select the number of the pattern with the fewest vertical lines.

In the illustration above, the pattern with the fewest vertical lines is “5”, so select “5.”

If you want to print the print head alignment pattern again, to check it, set a disc in Stacker 1, and click **Realign**.

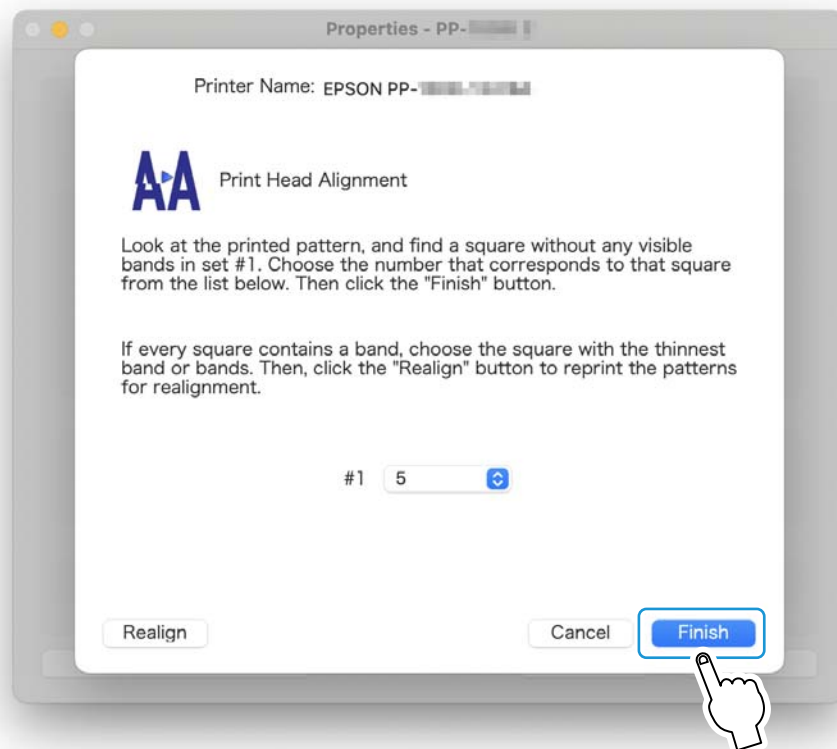

7 Click **Finish**.

Correcting the Printing Position

Adjust the printing position if it has shifted towards the top, bottom, left, or right.

- 1 Set one unprinted disc into Stacker 1.
- 2 Display the **Printer Utility** screen of the EPSON Total Disc Utility.
See “[Properties screen \(General screen\)](#)” on page 41 for display procedure.
- 3 Click **Printing Position Correction**.

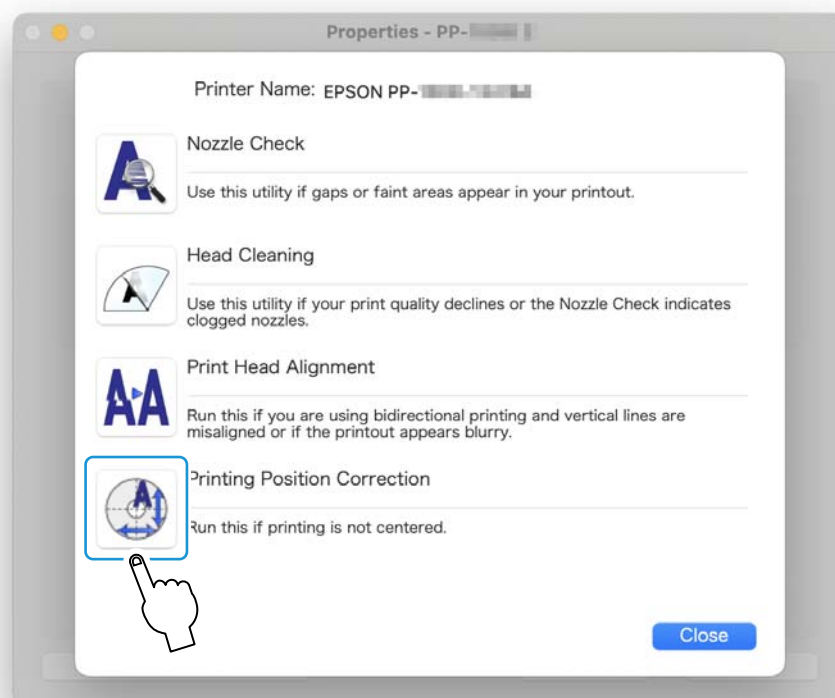

4 Click **Print**.

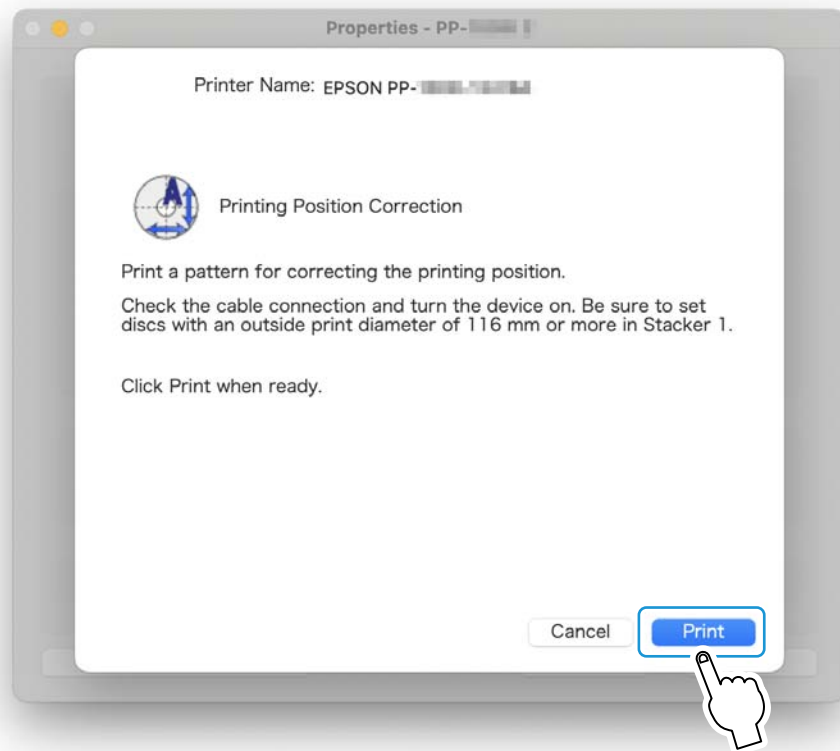

The disc on which there are five lines printed on the top, bottom, left and right respectively as well as one blue upward-pointing arrow is output to Stacker 3 or Stacker 4.

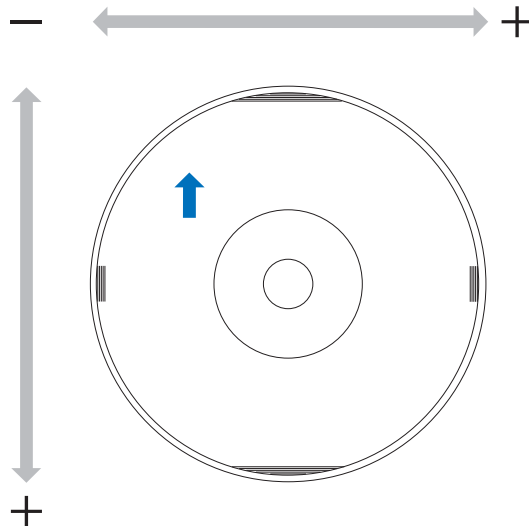

5 Click **Finish** if the lines on the top, bottom, left and right are evenly printed on the label surface. If they are not printed evenly, adjust the alignment in one of the following ways.

- If the printing has shifted to the left: Select a positive correction value in **Horizontal**.
- If the printing has shifted to the right: Select a negative correction value in **Horizontal**.
- If the printing has shifted to the top: Select a positive correction value in **Vertical**.
- If the printing has shifted to the bottom: Select a negative correction value in **Vertical**.

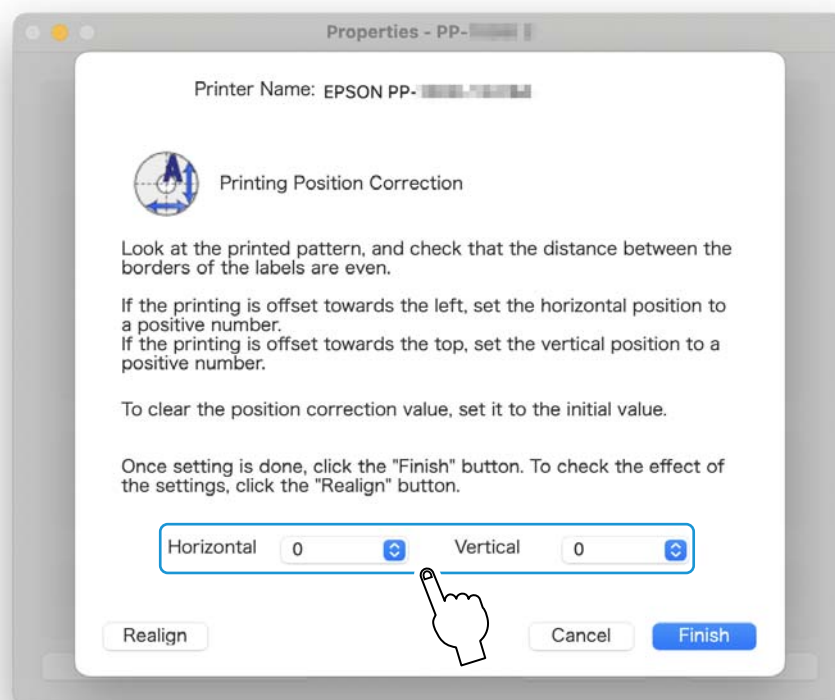

6 Set one unprinted disc into Stacker 1, and click **Realign**.

After this, repeat Steps 4 through 6 until the lines are printed evenly on the disc on the top, bottom, left, and right.

7 Click **Finish**.



- If you reenter a correction value after the first adjustment, the printing position is corrected using a correction value combined with the adjusted value from the first time. If you want to clear the printing position correction value, select **Reset**, and then click **Finish**.
- If the label application is not centered on the disc, even after you adjust the printing position using the steps above, the printing appears to have shifted with respect to the label application.

Cleaning Your Product

To keep your product operating at its best, clean it by using the following procedure.

Cleaning the Exterior

- 1** Turn the product off.
See “Turning Off the Power” on page 20.
- 2** After the Power light goes off, unplug the power plug from the outlet.
- 3** Use a soft cloth to wipe off the dust and dirt.
When the exterior is very dirty, soak a soft cloth in water with a small amount of mild detergent, wring it out, and then wipe off the dirt. Finally, wipe off the moisture using a soft, dry cloth.

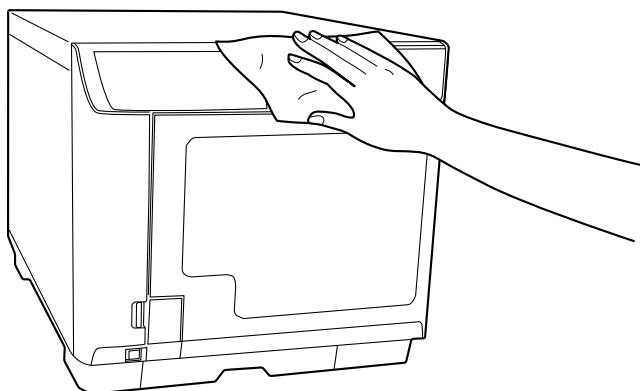

- Wipe with the covers closed so that moisture does not enter the inside of the product. If the inside becomes wet, there is a risk that the electrical circuits will short out.
- Do not use benzine, paint thinner, alcohol, or other volatile chemicals. There is a risk that the inside or outside of the product may change properties or shape.
- Do not use a stiff brush. There is a risk of scratching the exterior of the product.

- 4** Plug the power plug into the outlet, and turn the power on.

Cleaning the Interior

If dirt or dust collects in the inside of this product or the stackers, or if dirt adheres to it, use a soft cloth to wipe off the dirt.

Ink may sometimes stain stackers. Remove the stains by soaking a soft cloth in water or mild detergent, wringing it out, and then wiping them off.

Cleaning the Air Vents (Only for PP-100III/PP-50II)



Clean the air vents regularly (once every six months).

For PP-100III

- 1 Turn the product off.
See “Turning Off the Power” on page 20.
- 2 After the Power light goes off, unplug the power plug from the outlet.
- 3 Loosen the screws on the filter covers to open them.

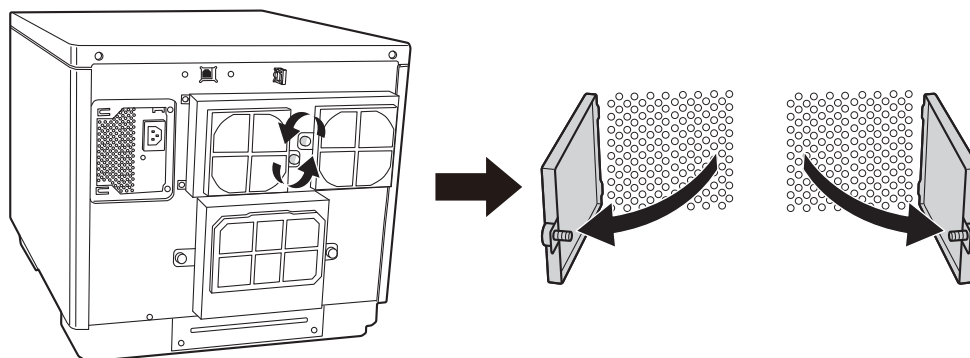

- 4 Take the filters off the filter covers.

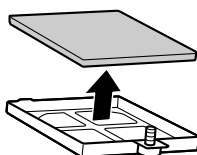

- 5 Use a vacuum cleaner to clean the dust off the filters.
- 6 Put the filters back on the filter covers.

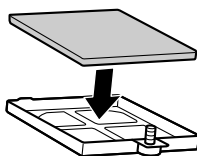

- 7** Tighten the screws to close the filter covers.

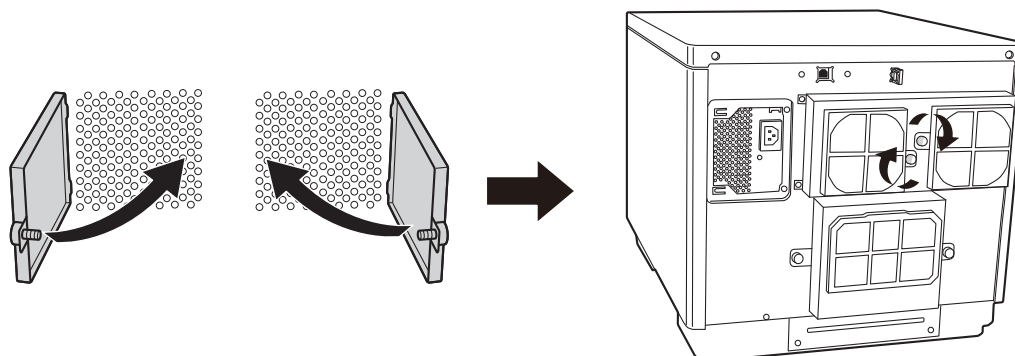

- 8** Plug the power plug into the outlet, and turn the power on.

For PP-50II

- 1** Turn the product off.
See [“Turning Off the Power” on page 20.](#)
- 2** After the Power light goes off, unplug the power plug from the outlet.
- 3** Loosen the screws on the filter covers to open them.

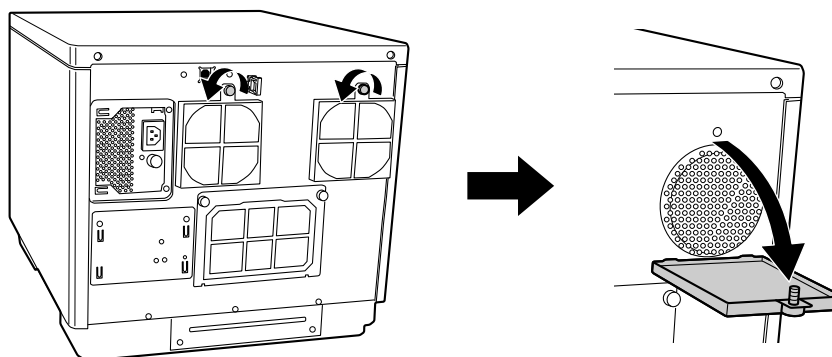

- 4** Take the filters off the filter covers.

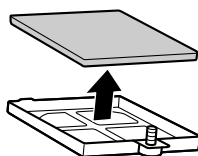

- 5** Use a vacuum cleaner to clean the dust off the filters.

- 6** Put the filters back on the filter covers.

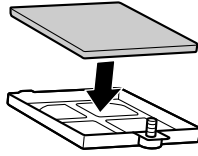

- 7** Tighten the screws to close the filter covers.

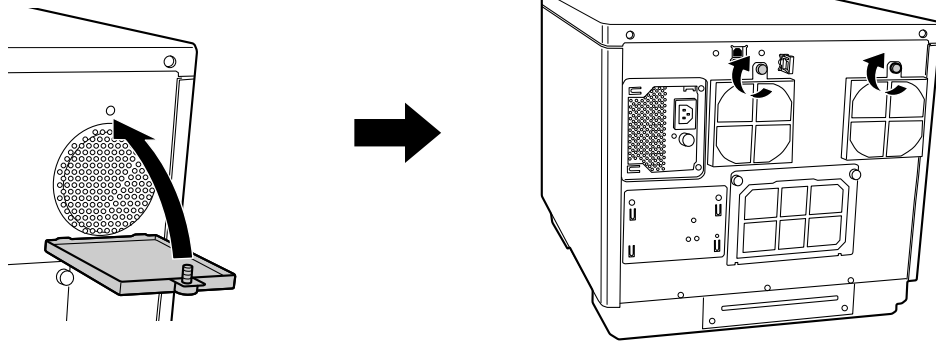

- 8** Plug the power plug into the outlet, and turn the power on.

Checking Maintenance Information

This section describes how to check information that is useful when carrying out maintenance and providing support for your product, such as usage status of the internal drives and the number of published discs.

- 1 Display the **Printer Utility** screen of the EPSON Total Disc Utility.
See “[Properties screen \(General screen\)](#)” on page 41 for display procedure.
- 2 Click the **Maintenance Info** tab.

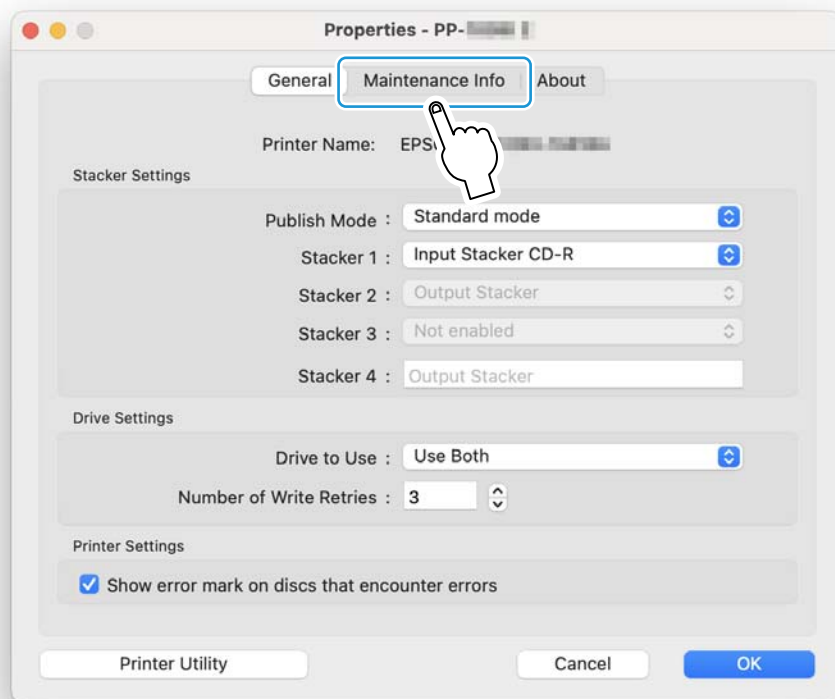

Maintenance information of your product appears.

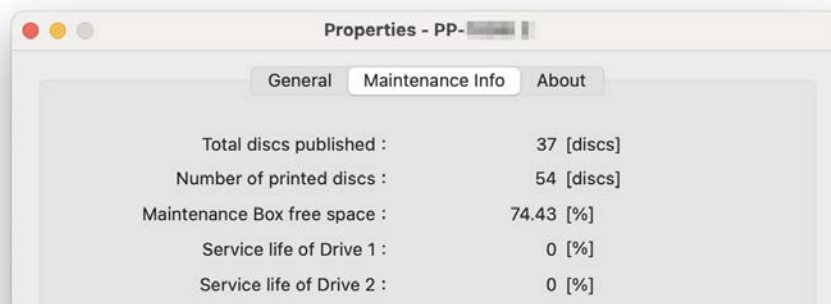

PP-100III

Item	Description
Total discs published	Cumulative number of discs the product has published (writing/printing).
Number of printed discs	Cumulative number of discs the product has printed.
Maintenance Box free space	Free space of the maintenance box (0 to 100%) If Maintenance Box free space is close to 0%, it is time to replace it.
Service life of Drive 1/2	Usage status of the drive 1 and drive 2. (0 to 100%) If Service life of Drive is close to 100%, it is time to replace it.

PP-50II

Item	Description
Number of printed discs	Cumulative number of discs the product has printed.
Service life of Drive	The usage status of the drive. If Service life of Drive is close to 100%, it is time to replace it.

PP-100AP



Item	Description
Number of printed discs	Cumulative number of discs the product has printed.
Maintenance Box free space	Free space of the maintenance box (0 to 100%) If Maintenance Box free space is close to 0%, it is time to replace it.

Replacing the Ink Pad (Only for PP-50II)

The ink pad is a part that absorbs waste ink ejected during head cleaning or printing. When it is time to replace the ink pad, publishing is no longer possible.

How to Check When it is Time to Replace the Ink Pad

The product notifies you when it is time to replace the ink pad in the following two ways.

- When  appears in the **Printer** status display of EPSON Total Disc Utility, it is almost time to replace the ink pad. Clicking  displays a message; **“The ink pad for this device will be full very soon. The device will stop functioning when the pad becomes full. Please consult your manual and take the recommended action immediately.”**
For EPSON Total Disc Utility, see [“EPSON Total Disc Utility” on page 39](#) or EPSON Total Disc Utility Help.
- When all the lights on the control panel turn on, it is time to replace the ink pad.

How to Replace the Ink Pad

The ink pad cannot be replaced by the customer. Please contact Customer Support.

Notes See [“Where to get help” on page 144](#).



Replacing the Maintenance Box (Only for PP-100III/PP-100AP)

The maintenance box is a part that absorbs waste ink ejected during head cleaning or printing. When it is time to replace the maintenance box, publishing is no longer possible.

How to Check When it is Time to Replace the Maintenance Box

You can check the free space of the maintenance box with EPSON Total Disc Utility. (See [“Checking Maintenance Information”](#) on page 100.)

When it is almost time to replace the maintenance box;

 appears in the **Printer** status display of EPSON Total Disc Utility. Clicking  displays a message; **“It is almost time to replace the Maintenance Box. Please prepare a new Maintenance Box.”**

When it is time to replace the maintenance box;

- The **INK** light starts flashing rapidly.
- EPSON Total Disc Utility displays a message; **“Printing is not possible, because it is time to replace the Maintenance Box. Please replace the Maintenance Box with a new one. Epson brand products are recommended.”**

For EPSON Total Disc Utility, see [“EPSON Total Disc Utility”](#) on page 39 or EPSON Total Disc Utility Help.

How to Replace the Maintenance Box

See the instruction manual of the maintenance box to replace the maintenance box. Be sure to also replace the filter when you replace the maintenance box.

See [“Ink cartridges and Maintenance Box”](#) on page 154 for the maintenance box model number. The instruction manual and the filter are included with the maintenance box.



- When it is time to replace the maintenance box, job processing automatically stops. You can replace the maintenance box without turning the power off, and then resume job processing. However, do not move the product or subject it to any impact while processing a job.
- Use of an Epson brand maintenance box is recommended. Use of non-Epson brand maintenance boxes can result in problems that will not be covered by the warranty.
- Epson cannot guarantee the quality and reliability of non-Epson brand products. Repairs for any damage or breakdown of this product due to the use of non-Epson brand products will not be free of charge even if the warranty period is still valid.
- Use of non-Epson brand products can adversely affect the printing quality and prevent the product from realizing its maximum performance.
- Do not use any maintenance box removed from the product and left for a long period.
- Do not tilt the used maintenance box. Otherwise ink may leak.
- Be careful no to touch the ink on the maintenance box cover and filter cover.



- Do not take out/put in the maintenance box more than necessary. Otherwise some parts of the ink pad may drop inside the product.
- Do not touch the green IC chip on the maintenance box.
- Do not touch the ink ejection port of the maintenance box or the inside of the box insertion opening of the product.

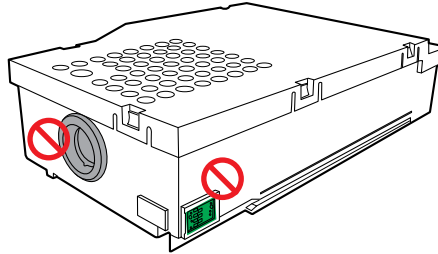

Replacing the Drive (Only for PP-100III)

When a drive has reached the end of its service life, writing errors can easily occur. In that case, replace the drive. You can replace the drives of the PP-100III yourself.



- Be sure to follow the instruction manual of the PP-100III exclusive optional drive to replace the drive.
- Both drive 1 and drive 2 must be installed. Otherwise, the PP-100III will not operate.

How to Check When it is Time to Replace the Drive

You can check the service life of the drives with EPSON Total Disc Utility. (See [“Checking Maintenance Information” on page 100.](#))

For EPSON Total Disc Utility, see [“EPSON Total Disc Utility” on page 39](#) or EPSON Total Disc Utility Help.

How to Replace the Drive

See the instruction manual of the drive to replace the drive.

See [“Drive \(Only for PP-100III\)” on page 154](#) for the drive model number.

Precautions for Transporting Your Product

When transporting your product, be sure to use the original box and protective materials to protect it from an impact or the like. See *Setup Guide for Mac* for details on the handling of protective materials.



- Make sure that no discs remain inside the product.
- For PP-100III, be sure to remove drive 1 and drive 2 before transporting. Otherwise, the drives and PP-100III may be deformed or damaged.
- Never remove ink cartridges currently in use. Otherwise, the print head may dry out, and printing may become no longer possible.
- For PP-100III and PP-100AP, never remove maintenance box. Otherwise, ink may leak.
- When attaching protective materials or transporting the product, do not tilt the product or turn it upside down. Make sure that it is oriented horizontally.
- **Be sure that the product is lifted by two people.**

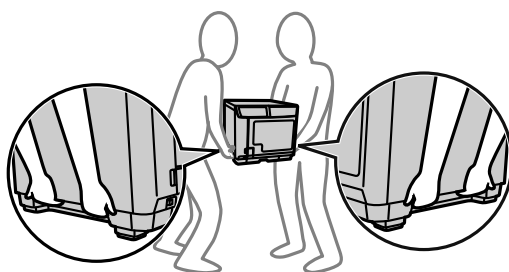

The weight of this product is as follows.

*PP-100III: approximately 24.0 kg

*PP-50II: approximately 21.0 kg

*PP-100AP: approximately 22.0 kg

When this product is lifted, it should be lifted on both sides by two people holding the recesses on the sides as shown in the illustration on the left. Holding any part other than the ones indicated in the illustration on the left when carrying the

product may result in damage to the product. In particular, carrying the product while the disc cover, ink cartridge cover, or Stacker 4 (only for PP-100III/PP-100AP) is open may result in the product being dropped, or deformed and damaged.

Furthermore, when putting down this product, take care not to trap a finger between the product and installation surface.

- **When lifting this product, make sure that, for example, you sufficiently bend your knees, and your posture is such that excessive stress is not placed on your body.**
An unnatural posture when lifting the product may result in an injury, or the product being damaged.
- **When moving the product, do not tilt it 10 or more degrees in a forward or backward direction, or a side direction.**
The dropping or the like of the product may result in an accident.
- **Do not place a heavy object on the top of the product.**
Subjecting this product to excessive force may result in a malfunction.
However, for PP-100III and PP-100AP, it is possible to place one unit of this product on top of another. In such a case, make sure the tops and bottoms are oriented the same, and the exterior of the units are aligned. **At the same time, take sufficient care to prevent a unit from dropping or falling. Also, do not place more than one unit on top of another.**

- 1** Turn the product off.
See [“Turning Off the Power” on page 20](#).
- 2** After the Power light goes off, disconnect the power cord and USB cable.
- 3** For PP-100III, remove drive 1 and drive 2.
For the procedure, see the instruction manual of the drive.
- 4** Attach protective materials to the arm, and secure them with tape.
- 5** Attach Stacker 1, Stacker 2, and Stacker 3 (only for PP-100III/PP-100AP), and secure them with tape.
- 6** Open the ink cartridge cover, and secure the ink cartridges with tape.
- 7** Close the ink cartridge cover, disc cover, and Stacker 4 (only for PP-100III/PP-100AP), and secure them with tape.
- 8** With the bottom of the product facing downwards, place the product into the packing box so that it is oriented horizontally.

Troubleshooting

Notes

- Refer to this information together with the EPSON Total Disc Utility Help and the information available on the Epson website.
- If your problem cannot be resolved even after the following remedies, contact customer support services for assistance. (See [“Where to get help” on page 144.](#))

Problems and their Remedies

Power/Control Panel Problems

Symptom/Problem Status	Check/Remedy Procedure
The power does not turn on.	Press and hold the power button for at least 1 second, and then release it.
	Is the power plug disconnected from the outlet? Check if the plug is inserted only half-way or inserted at a slant.
	Are you using a power strip or similar device? Insert the power plug directly into the wall outlet.
	Is power being supplied from the outlet? Insert the power cable plug for another electronic product to check if power is being supplied.
The power does not turn off.	Press and hold the power button for at least 3 seconds. If the power still does not turn off, unplug the power cord from the outlet. After confirming that the power lamp is off, connect the power plug to the outlet, turn on the power again, and be sure to use the power button to turn off the power. Leaving the power on can cause drying and clogging of the print head.
A rattling sound is made when the power is turned on.	Is there a foreign object (such as blue protective tape for transporting) inside the product? Press the power button to turn off the power, and then open the disc cover and check that there are no foreign objects inside.
Light on the control panel flashes/turns on.	An error has occurred. See “Checking Lights for Errors” on page 115.

Disc Transferring (Input/Output) Problems

Symptom/Problem Status	Check/Remedy Procedure
The arm does not move.	<p>Is there a foreign object (such as blue protective tape for transporting) inside the product?</p> <p>Press the power button to turn off the power, and then open the disc cover and check that there are no foreign objects inside.</p>
Unable to transfer a disc.	<ul style="list-style-type: none"> • If a disc is not transferred from a stacker <ol style="list-style-type: none"> 1. Open the disc cover. 2. Take out discs from the input stacker. 3. Fully separate the discs to prevent them from sticking together and load them back into the stacker. 4. Close the disc cover. 5. Retry to publish a disc. • If a disc is not transferred from the drive tray or the printer tray <ol style="list-style-type: none"> 1. Turn the product off. 2. Remove the disc from the tray. (See “Disc Does not Come Out” on page 129.) 3. Turn the product on. 4. Retry to publish a disc. • If the arm has picked up a disc <p>Do not remove the disc by hand, as the arm may be damaged. To remove the disc, turn off the power and turn on the power again, and let the initialization process remove the disc.</p>
Unable to output a disc	<p>Is there a foreign object (such as blue protective tape for transporting) inside the product?</p> <p>Press the power button to turn off the power, and then open the disc cover and check that there are no foreign objects inside.</p> <p>If the problem still cannot be solved, see “Disc Does not Come Out” on page 129.</p>
Unable to release multiple disc feeds error	<p>Is there a problem with the disc?</p> <p>Multiple disc feeds error may occur depending on disc thickness or warpage, even when multiple discs are not transferred. In that case, follow the steps below to clear the error, and then retry using another disc.</p> <ol style="list-style-type: none"> 1. Open the disc cover. 2. Remove the disc from the tray. 3. Take out the discs from the input stacker. 4. Load another disc into the input stacker. 5. Close the disc cover and the job will resume.

Disc Writing Problems (Only for PP-100III/PP-50II)

Symptom/Problem Status	Check/Remedy Procedure
A writing error has occurred.	<p>Is the disc scratched or dirty? Scratched or dirty discs cannot be used. Replace with another disc.</p>
	<p>The quality of the data recording surface may vary depending on the disc. Replace with another disc and try again.</p>
	<p>Is there dust adhering to the filter of the product rear fan? Clean the filter. (See “Cleaning the Air Vents (Only for PP-100III/PP-50II)” on page 97.)</p>
Unable to write to disc	<p>Is the disc being handled correctly?</p> <ul style="list-style-type: none"> • Handle the disc correctly by following the instruction manual of the disc. • Do not affix adhesive stickers to the disc. This may make recording and playback of data no longer possible. • Do not use this product in locations with large amounts of dust or smoke. This can cause drive writing errors. <p>See “Handling Discs” on page 51.</p>
	<p>Was the cover opened or the product jolted during publishing? Do not subject the product to jolts or impacts during disc publishing. The drive may malfunction, or the disc may become unusable. Also, do not open the cover during publishing. This could adversely affect the printing and writing quality of the disc. Before opening the cover, pause the job in EPSON Total Disc Utility.</p>
	<p>Is your PC compatible with the operating environment of this product? Use and connect this product to a PC compatible with the operating environment. (See “System Requirements” on page 27.)</p>
	<p>Is the printer tray dirty? Clean the printer tray. (See “Disc Recording Surface is Stained with Ink” on page 137.)</p>

Notes

When disc publishing in EPSON Total Disc Maker, Setting **Write Verification** to **Compare** enables checking whether data was written correctly. See EPSON Total Disc Maker Help for details.

Label Printing Problems

Symptom/Problem Status	Check/Remedy Procedure
<ul style="list-style-type: none"> • Rubbing • Lines or streaks are formed • Blurriness • Text or lines are shaky • Incorrect color tones • Some colors are not printed • Unevenness in the printing • Mosaic-like patterns are printed • Printing is grainy (jagged) 	<p>Are the print head nozzles clogged?</p> <p>Perform a nozzle check to confirm the status of the print head, and if it is clogged, perform head cleaning.</p> <p>See the information below for details.</p> <ul style="list-style-type: none"> • “Checking the Print Head Nozzles” on page 85 • “Cleaning the Print Head” on page 87
	<p>Are you using a recommended ink cartridge (Epson brand product)?</p> <p>This product performs color adjustment based on use of Epson brand ink cartridges. Use of non-Epson brand products can result in poor printing quality. Use of Epson brand ink cartridges is recommended.</p>
	<p>Are you using an old ink cartridge?</p> <p>Use of an old ink cartridge can result in poor printing quality. The usage period for ink cartridges is printed on the packaging of individual ink cartridges. After opening the cartridge, try to use it up within six months.</p>
	<p>Is there a difference in the print head gaps during bidirectional printing?</p> <p>When bidirectional printing is set, printing is performed at a high speed, and ink is discharged as the print head moves to both the left and right. On rare occasions, however, the printing position when moving from right to left is shifted from the printing position when moving from left to right, leading to shifting of the vertical rule lines and blurred printing results. Use the print head alignment function to check and adjust for differences in the gap. (See “Aligning the Print Head” on page 90.)</p>
	<p>Are you using discs with different thicknesses?</p> <p>The thickness varies depending on the disc product. When discs with different thicknesses are used, the gaps of the print head can be shifted. Use the print head alignment function to check and adjust for differences in the gap. When publishing multiple discs, the use of the same disc product type is recommended. (See “Aligning the Print Head” on page 90 for details.) Or print with unidirectional printing. However, with unidirectional printing, print speed will be slower.</p>
	<p>Are you printing on inkjet printer discs?</p> <p>The product supports discs for inkjet printers. This product does not support thermal transfer printer discs. Also, the printing quality may vary depending on the quality of the printing discs. Use of Epson specified CD and DVD discs is recommended.</p> <p>Epson offers specified CD-R and DVD-R discs for all your printing needs.</p>

Symptom/Problem Status	Check/Remedy Procedure
<ul style="list-style-type: none"> • Rubbing • Lines or streaks are formed • Blurriness • Text or lines are shaky • Incorrect color tones • Some colors are not printed • Unevenness in the printing • Mosaic-like patterns are printed • Printing is grainy (jagged) 	<p>Is there dirt on the disc?</p> <p>Gently wipe off any dust or dirt adhering to the label side using a soft cloth. Do not use benzene, thinner, or antistatic agents.</p> <p>See "Handling Discs" on page 51 for details.</p>
	<p>Is the printing surface fully dry?</p> <p>Do not let other discs get in contact with the printing surface until the ink on the published disc is dry. Otherwise, marks can be left where contact is made.</p>
	<p>Is the ink drying time set too short?</p> <p>The ink drying time is the time after label printing is completed until the disc ink is dried in the printer tray. Set a longer ink drying time.</p> <ul style="list-style-type: none"> • When publishing with EPSON Total Disc Maker: Set in Publish view. • When publishing with other applications: Set with the printer driver. (See "Print Settings area" on page 46.)
	<p>Are you comparing the display on the PC to the printing results?</p> <p>The colors shown on the display and the results printed by the printer use different coloring methods, and this produces differences in color tones.</p>
<p>Unable to print correctly in the print area of the disc.</p>	<p>Set the inside diameter and outside diameter of the print area so that they match the print area of the disc to be printed.</p> <p>See "Printable Area" on page 53 for details. See "Printing on User Defined Label Size Discs" on page 75 for the setting procedure of the inside diameter and outside diameter.</p>
<p>Printing position is shifted.</p>	<p>Correct the printing position if it is shifted. (See "Correcting the Printing Position" on page 93.)</p>
<p>The disc recording surface is stained with ink.</p>	<p>Is the ink drying time set too short?</p> <p>The ink drying time is the time after label printing is completed until the disc ink is dried in the printer tray. Set a longer ink drying time.</p> <ul style="list-style-type: none"> • When publishing with EPSON Total Disc Maker: Set in Publish view. • When publishing with the other applications: Set with the printer driver. (See "Print Settings area" on page 46.)
	<p>Is the printer tray dirty?</p> <p>When the disc recording surface is stained by ink, the printer tray may be dirty. Clean the printer tray. (See "Disc Recording Surface is Stained with Ink" on page 137.)</p>
<ul style="list-style-type: none"> • After printing, the label surface ink is sticky or peels off • Discs stick together 	<p>Was printing performed outside the recommended print area?</p> <p>If printing is performed outside the recommended print area, after printing, the label surface ink is sticky or peels off, or discs stick to each other.</p> <p>See "Print Settings area" on page 46 for details.</p>

Other Problems

Symptom/Problem Status	Check/Remedy Procedure
<p>Unable to install software</p>	<p>Is the USB cable unplugged? Make sure the USB cable is firmly connected.</p>
	<p>Is the USB cable compliant with the product? See “Interfaces” on page 153 for the interface specifications.</p>
	<p>Is there enough available HDD space? The software cannot be installed unless there is at least 25 GB of available HDD space. Check the amount of available HDD space, and if there is not enough space, increase the amount of available space. Available HDD space needs to be enough to enable the software to run normally. (See “System Requirements” on page 27.)</p>
	<p>Are you using a USB hub? The USB cable should be connected directly between the PC and the product.</p>
	<p>Is the power of the PC connected to the product on when installing the software? When installing the software, make sure to turn the product off; then start installation.</p>
<p>The drive cannot be used.</p>	<p>Is use of the drive stopped? When a write error occurs based on a preset retry write count, use of the drive is automatically stopped. Set Drive to Use in Properties screen of EPSON Total Disc Utility to restart the drive. (See “Properties Setting” on page 28.)</p>
<p>Head cleaning does not work.</p>	<p>Hold down the cleaning button for a moment.</p>
	<p>Has an error occurred in the product? If an error has occurred, clear the error.</p>
	<p>Is there enough ink? Head cleaning cannot be performed unless there is enough ink. Replace with a new ink cartridge. (See “How to Replace the Ink Cartridges” on page 82.)</p>
<p>The printing speed slowed down during continuous printing.</p>	<p>When printing is performed for an extended period of time, disc transfer and printing may be stopped temporarily. This is for slowing the printing speed to prevent overheating and damage to the product. Although printing can be continued when this occurs, it is recommended that you stop product operation and leave it with the power on for about 30 minutes. (The product will recover after about 3 hours with the power off.)</p>
<p>Unable to publish discs.</p>	<p>See “When Discs Cannot be Published” on page 125.</p>

Symptom/Problem Status	Check/Remedy Procedure
<p>Unable to use a disc image (.INI) created in the Windows version of Total Disc Maker in the macOS version of Total Disc Maker.</p>	<p>Disc images from the Windows version cannot be used in macOS.</p>
<p>A job cannot be registered in Total Disc Utility even after it is published.</p>	<p>Start up the uninstaller and uninstall Total Disc Maker and the printer driver, and then reinstall Total Disc Maker Ver. 3.6 or later.</p>

Checking Lights for Errors



If resuming label printing after an error, run a nozzle check and confirm the condition of the print head.
See ["Checking the Print Head Nozzles" on page 85](#) for details on the nozzle check.

Notes

You can check error status and remedies also in EPSON Total Disc Utility.
See EPSON Total Disc Utility Help for details.

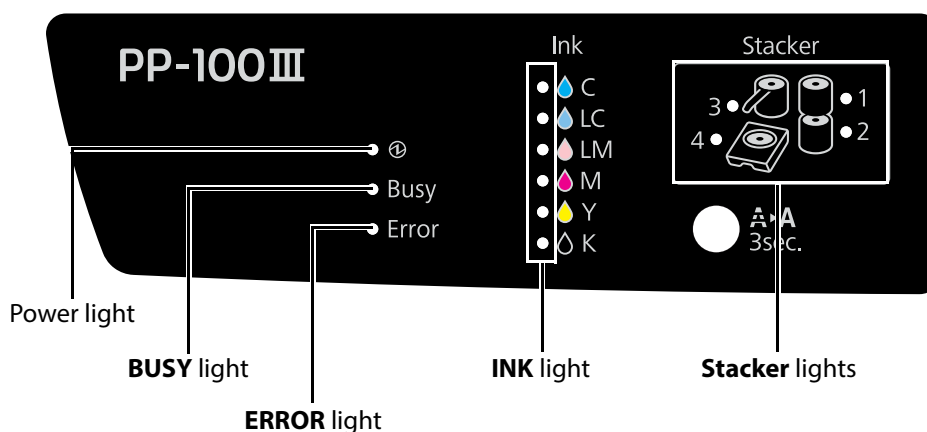

*PP-50II does not have the **STACKER 4** light.

The light statuses are indicated as follows.

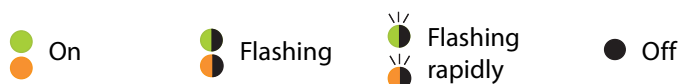

Error Associated with Covers

Lights								Conditions/Remedies
Power	BUSY	ERROR	INK	STACKER				
				1	2	3	4	
●	●	◐	●	●	●	●	●	<p>Disc cover or ink cartridge cover open Close covers.</p> <p>A job is in the recovering status because disc cover or ink cartridge cover was opened while processing the job. Wait for the job to be in the standby status.</p>

Error Associated with Disc Transfer

Lights								Conditions/Remedies
Power	BUSY	ERROR	INK	STACKER				
				1	2	3	4	
								<p>Disc pick error</p> <p>Resolve the problem as follows.</p> <ol style="list-style-type: none"> 1. Open the disc cover and fully separate the discs in the input stacker to prevent them from sticking together. 2. Close the disc cover and retry to publish a disc.
●	●	●	●	●	●	●	●	<p>Multiple feed error</p> <p>Resolve the problem as follows.</p> <ol style="list-style-type: none"> 1. Open the disc cover. 2. Remove all the discs from both the drive tray and the printer tray. 3. Fully separate the discs in the input stacker to prevent them from sticking together. 4. Close the disc cover and retry to publish a disc. <p>Do not turn on/off the product without removing the discs. The product may be damaged.</p>

Lights								Conditions/Remedies
Power	BUSY	ERROR	INK	STACKER				
				1	2	3	4	
●	●	●	●	●	●	●	●	<p>Disc transfer error Resolve the problem as follows.</p> <ol style="list-style-type: none"> 1. Turn the product off. 2. Remove the disc. 3. Turn the product on and retry to publish a disc. <hr/> <p>Arm failed to release a disc Resolve the problem as follows.</p> <ol style="list-style-type: none"> 1. Turn the product off. 2. Remove the disc. <p>If the arm has picked up a disc, do not remove the disc by hand, as the arm may be damaged. To remove the disc, turn on the power again, and let the initialization process remove the disc.</p> <ol style="list-style-type: none"> 3. Turn the product on and retry to publish a disc. <p>If the disc is left in the drive tray or printer tray, remove it from the tray. (See “Disc Does not Come Out” on page 129.)</p> <hr/> <p>Internal error Resolve the problem as follows.</p> <ol style="list-style-type: none"> 1. Turn the product off. 2. Open the disc cover and check that there are no foreign objects inside; then close the disc cover. <p>If the arm has picked up a disc, do not remove the disc by hand, as the arm may be damaged. To remove the disc, turn on the power again, and let the initialization process remove the disc.</p> <ol style="list-style-type: none"> 3. Turn the product on and retry to publish a disc.

Error Associated with Stacker

Lights								Conditions/Remedies
Power	BUSY	ERROR	INK	STACKER				
				1	2	3	4	
●	●	●	●	●	●	●	●	<p>Stacker 3 is inserted for Standard mode or External Output mode (when Stacker 4 is set as the output stacker).</p> <p>Remove Stacker 3.</p>
●	●	●	●	●	●	●	●	<p>Stacker 1 is not correctly inserted.</p> <p>Insert Stacker 1 correctly.</p>
●	●	●	●	●	●	●	●	<p>Stacker 2 is not correctly inserted.</p> <p>Insert Stacker 2 correctly.</p>
●	●	●	●	●	●	●	●	<p>Stacker 3 is not correctly inserted for External Output mode (when Stacker 3 is set as the output stacker) or Batch mode.</p> <p>Insert Stacker 3 correctly.</p>
●	●	●	●	●	●	●	●	<p>Stacker 1 is empty.</p> <p>Load discs into Stacker 1.</p> <p>Note: The Stacker 1 light flashes when it is empty; however, the beginning of the light flashing may not match the exact time that the stacker becomes empty.</p>
●	●	●	●	●	●	●	●	<p>Stacker 2 (set as the input stacker) is empty.</p> <p>Load discs into Stacker 2.</p> <p>Note: The Stacker 2 light flashes when it is empty; however, the beginning of the light flashing may not match the exact time that the stacker becomes empty.</p>
●	●	●	●	●	●	●	●	<p>Stacker 1 is overloaded.</p> <p>Remove discs so that discs are below the dotted red line on the stacker.</p>
●	●	●	●	●	●	●	●	<p>Stacker 2 (set as the input stacker) is overloaded.</p> <p>Remove discs so that discs are below the dotted red line on the stacker.</p>
●	●	●	●	●	●	●	●	<p>Stacker 3 is overloaded.</p> <p>Remove all the discs from Stacker 3.</p>
●	●	●	●	●	●	●	●	<p>Stacker 2 (set as the output stacker) is full.</p> <p>Remove published discs from Stacker 2.</p>

Lights								Conditions/Remedies
Power	BUSY	ERROR	INK	STACKER				
				1	2	3	4	
●	●	●	●	●	●	●	●	Stacker 3 is full. Remove published discs from Stacker 3.
●	●	●	●	●	●	●	●	Stacker 4 is full. Remove published discs from Stacker 4.
●	●	●	●	●	●	●	●	Stacker 4 is open. Close Stacker 4.

Error Associated with Ink

Lights								Conditions/Remedies
Power	BUSY	ERROR	INK	STACKER				
				1	2	3	4	
●	●	●	●	●	●	●	●	Ink low Prepare a new ink cartridge. Use of Epson brand ink cartridges is recommended.
●	●	●	●	●	●	●	●	The ink has reached its replacement time or it is not installed correctly. Replace the ink cartridge or reinstall it. (See “How to Replace the Ink Cartridges” on page 82.) If the ink cartridge is not recognized even if it is installed correctly, there may be dirt on the green circuit board. Wipe it with soft cloth and install it again. The product will stop operation before ink is completely empty in order to maintain print head quality. Therefore, some ink will be left in the ink cartridge. Use of Epson brand ink cartridges is recommended.









Error Associated with Printer

Lights								Conditions/Remedies
Power	BUSY	ERROR	INK	STACKER				
				1	2	3	4	
●	●	●	● ⚡	●	●	●	●	<p>The maintenance box has reached its replacement time or it is not installed correctly. Replace the maintenance box or reinstall it. (See “How to Replace the Maintenance Box” on page 103.)</p> <p>If the maintenance box is not recognized even if it is installed correctly, there may be dirt on the green circuit board. Wipe it with soft cloth and install it again.</p>
●	●	●	●	●	●	●	●	<p>Only for PP-50II The ink has reached its replacement time or it is not installed correctly. The ink pad cannot be replaced by the customer. Please contact Customer Support. (See “Where to get help” on page 144.)</p> <p>Printer maintenance error Contact customer support for details. (See “Where to get help” on page 144.)</p>

Error Associated with Drives (Only for PP-100III/PP-50II)

Lights								Conditions/Remedies
Power	BUSY	ERROR	INK	STACKER				
				1	2	3	4	
●	●	●	●	●	●	●	●	<p>Drive tray open/close error Resolve the problem as follows.</p> <ol style="list-style-type: none"> 1. Turn the product off and unplug the power cord. 2. Open the disc cover and check that there are no foreign objects inside; then close the disc cover. 3. Plug the power cord and turn on the power again. 4. Republish a disc.
								<p>Internal drive error Resolve the problem as follows.</p> <ol style="list-style-type: none"> 1. Turn the product off and unplug the power cord. 2. Open the disc cover and check the inside of the product; then close the disc cover. 3. Plug the power cord and turn on the power again.
●	●	●	●	●	●	●	●	<p>Writing error Resolve the problem as follows.</p> <ol style="list-style-type: none"> 1. Check the disc for any problem. Replace it with another disc if any problem was found. 2. Clean the fan filter if it is clogged with dust. (See "Cleaning the Air Vents (Only for PP-100III/PP-50II)" on page 97.) 3. Check if the drive has reached the end of the service life. If so, replace the drive. (See "Checking Maintenance Information" on page 100 and "Replacing the Drive (Only for PP-100III)" on page 105.)
								<p>Invalid disc error Check as follows.</p> <ol style="list-style-type: none"> 1. Check the disc type. If the disc loaded in the stacker differs from the disc type you set in the Properties screen of EPSON Total Disc Utility, change the disc or setting. (See "Properties Setting" on page 28.) 2. Check whether the disc has enough space to write the data. 3. Check whether the disc is blank.

Other Error



Lights								Conditions/Remedies
Power	BUSY	ERROR	INK	STACKER				
				1	2	3	4	
								Improper status error Turn the product off and back on.

Checking with EPSON Total Disc Utility

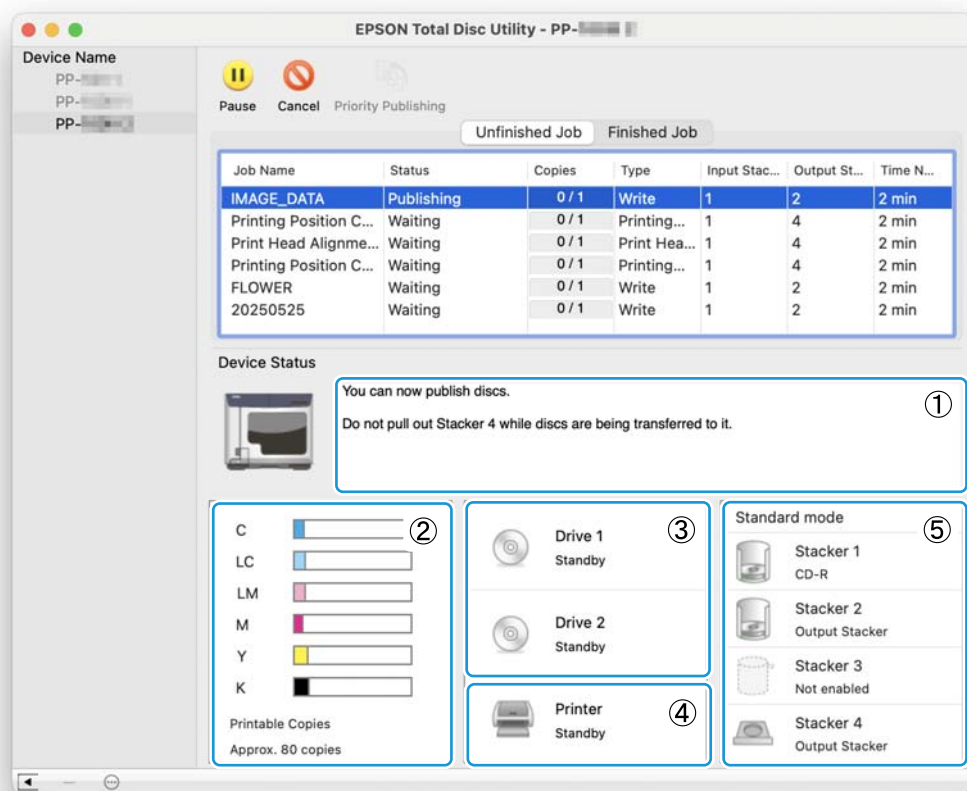
EPSON Total Disc Utility enables you to check the status of this product and the remedy procedures for errors. See “Starting EPSON Total Disc Utility” on page 39 for EPSON Total Disc Utility start procedure.



1	Operation Guidance	This displays the status of this product, error descriptions and messages. Check the product by referring to the displayed remedy procedure.
2	Ink Status	This displays the remaining ink level. The ink level is low when is displayed. Prepare a new ink cartridge. The ink should be replaced when is displayed. Replace with a new ink cartridge. (See “Replacing the Ink Cartridge” on page 81.)
3	Drive Status (PP-100III/PP-50II)	This displays the CD/DVD drive status. When is displayed, check the product drive by referring to the displayed message.
4	Printer Status	This displays the printer status. When is displayed, check the product printer by referring to the displayed message. When is displayed, click to check the displayed message.

5	Stacker Status	<p>This displays the stacker status.</p> <p>When  is displayed, either the number of discs in the input stacker is low, or the discs in the output stacker are nearly full.</p> <p>If the number of discs in the input stacker is low, obtain new discs.</p> <p>If the discs in the output stacker are nearly full, taking out discs is recommended before publishing the next job.</p> <p>When  is displayed, check the stacker and discs by referring to the displayed message.</p>
---	----------------	---

When Discs Cannot be Published

If the disc is not published by clicking **Publish** in the **Publish** view of EPSON Total Disc Maker, or if the product does not work, check the points below.

Check 1: Check of EPSON Total Disc Utility

Is an error message displayed in EPSON Total Disc Utility?

Check the status of this connected product in EPSON Total Disc Utility, and perform the remedy if an error has occurred.

See the references below for details on EPSON Total Disc Utility.

- [“EPSON Total Disc Utility” on page 39.](#)
- EPSON Total Disc Utility Help

Check 2: Check of the product

Is the power light turned on?

If the power light is not turned on, the power for the product is turned off.

Turn on the power by referring to [“Power/Control Panel Problems” on page 108 in this guide.](#)

*Is the **ERROR** light flashing or turned on?*

If the **ERROR** light is flashing or turned on, an error has occurred in this product.

See [“Checking Lights for Errors” on page 115](#) for the error checking and remedy procedures.

Check 3: Check of connection between the product and PC

Is the USB cable disconnected?

Check that the USB cable is connected. Also, check that the USB cable does not have a broken wire or is bent.

Is the USB cable compatible with the PC and product specifications?

If you use USB cable other than one supplied with the product, check that it is compatible with the specifications.

See [“Interfaces” on page 153](#) for the interface specifications.



Intel 5 Series chip set or earlier is incompatible with PP-100III.

Are you using a USB hub?

The USB cable should be connected directly between the PC and the product.

Check 4: Check of printer driver settings

Is the printer registered?

- 1 Click  [System Preferences] in the Dock.
- 2 Click  [Printers & Scanners] in Hardware.
- 3 Check that this product icon (EPSON PP-xxx-xxxxxx) is found in **Printers**.

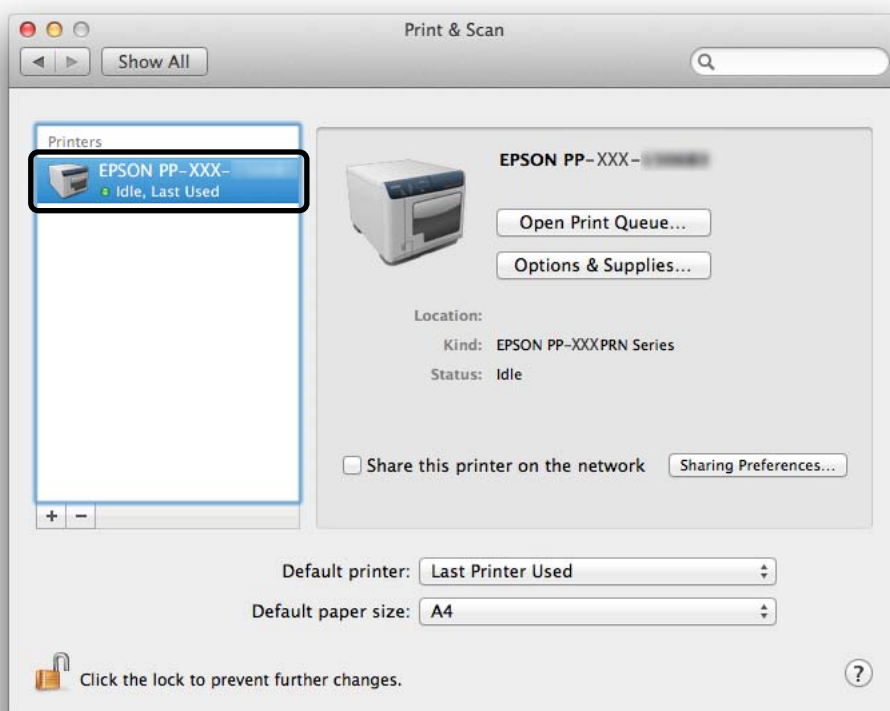

If the icon is not found, the printer is not registered. See *Setup Guide for Mac* to register the printer.

Is the printer set to Pause?

If Paused is displayed for the product's icon (EPSON PP-xxx-xxxxxx), follow the steps below to resume the printer.

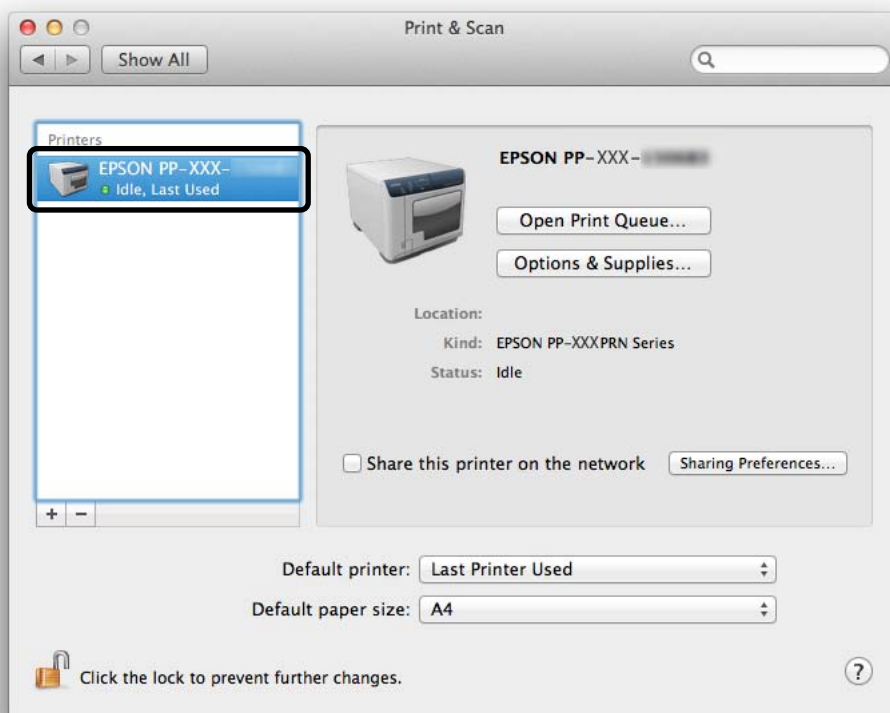

- 1 Select the product icon (EPSON PP-xxx-xxxxxx) and double-click **Open Print Queue...**
- 2 Click **Resume Printer**.

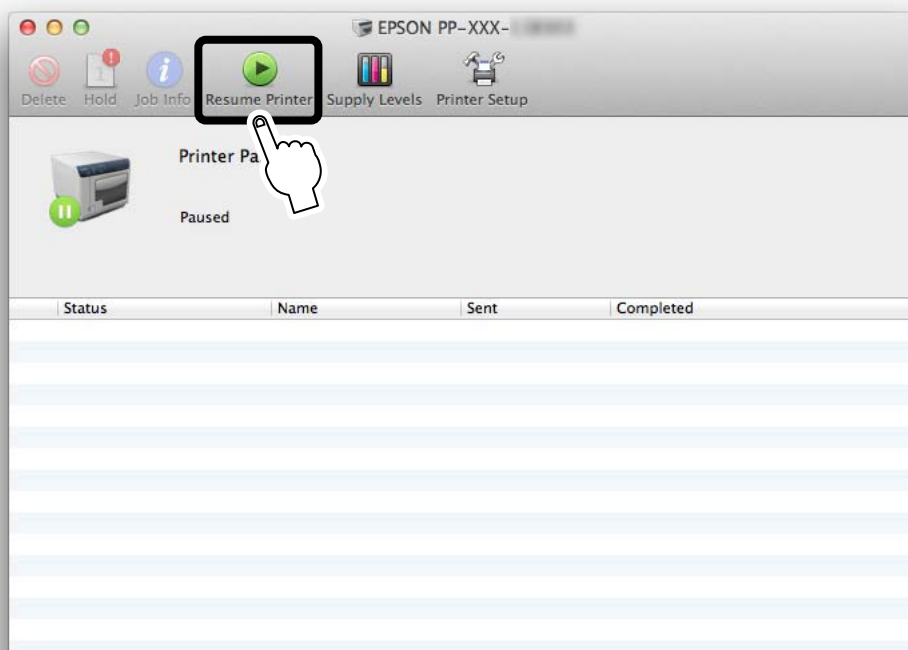

If performing all of the above checks still does not resolve the problem, the software may not be installed correctly. Uninstall (delete) the software, and then reinstall it.

See [“Uninstalling the Software” on page 33](#) for the software uninstallation procedure.

See *Setup Guide for Mac* for the software installation procedure.

Please contact Customer Support if this still does not resolve the problem. When making inquiries, please provide information about your operating environment (including the PC model, names and versions of software applications, and other peripheral models), name of this product, and its serial number.

Disc Does not Come Out

Perform the procedure below if the disc cannot be ejected because the drive tray or printer tray does not come out.

Drive Tray Does not Come Out (Only for PP-100III/PP-50II)

Turn the power of the product off and then on again. If the drive tray still does not come out, perform the procedure below.

- 1** Turn the product off.
See [“Turning Off the Power”](#) on page 20.
- 2** After the Power light goes off, unplug the power plug from the outlet.
- 3** Wait about one minute until the disc stops rotating, and then open the disc cover.
- 4** Insert a hard pin into the eject hole of the drive to open the tray.

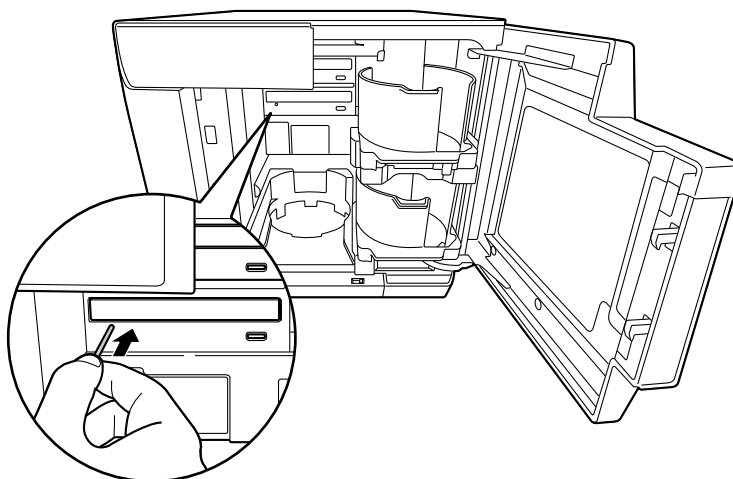

When inserting the pin into the eject hole, be sure that the power of the product is off.

- 5** Pull out the disc, and gently push in the drive tray to close.



The product can be damaged if you leave the drive tray open when turning on the power of the product. Be sure to always close the drive tray.

- 6** Close the disc cover.
- 7** Insert the power plug into the outlet, and turn on the power.

Printer Tray Does not Come Out

Turn the power of the product off and then on again. If the printer tray still does not come out, perform the procedure below.

For PP-100III

- 1 Turn the product off.
See [“Turning Off the Power”](#) on page 20.
- 2 After the Power light goes off, unplug the power plug from the outlet.
- 3 Remove the two screws to remove the maintenance box cover.

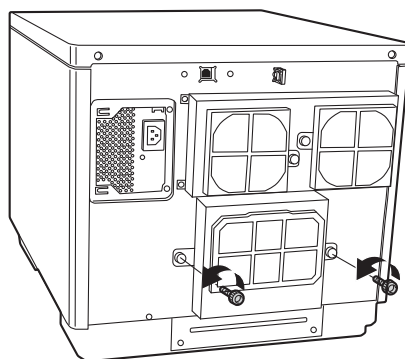

- 4 Grasp the fixture as shown in the figure below, and push the printer tray in the direction of the arrow indicated below.

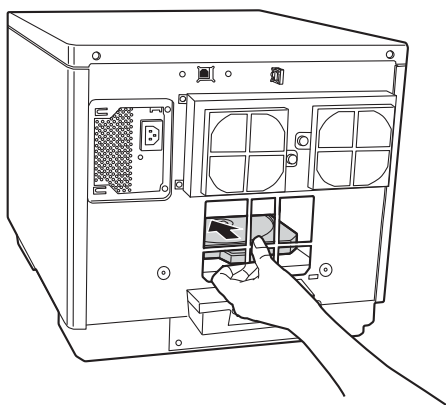

- 5 Open the disc cover.

- 6** Pull out the printer tray.

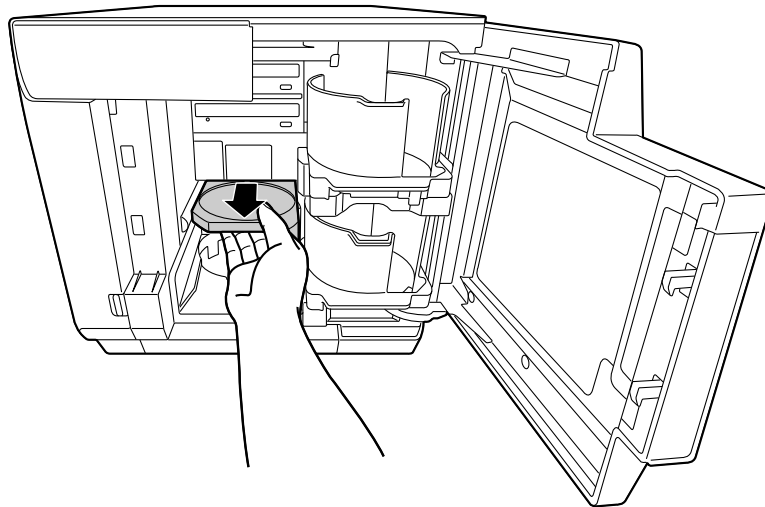

- 7** Remove the disc, and close the disc cover.
The printer tray automatically closes when the power is turned on in Step 9.

- 8** Reattach the maintenance box cover.

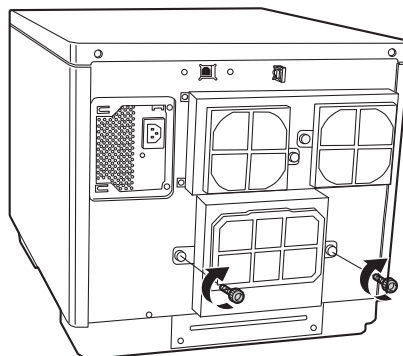

- 9** Insert the power plug into the outlet, and turn on the power.

For PP-50II

- 1** Turn the product off.
See [“Turning Off the Power”](#) on page 20.
- 2** After the Power light goes off, unplug the power plug from the outlet.
- 3** Remove the two screws to remove the rear printer cover.
If the disc can be removed, eject the disc and reattach the rear printer cover. If the disc cannot be removed, proceed to the procedure below.

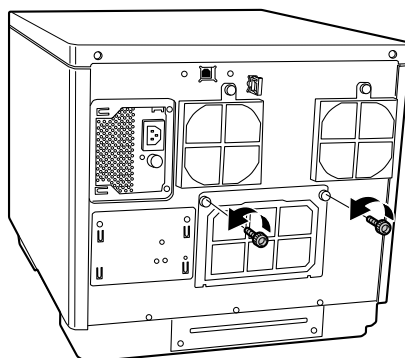

- 4** Grasp the fixture as shown in the figure below, and push the printer tray in the direction of the arrow indicated below.

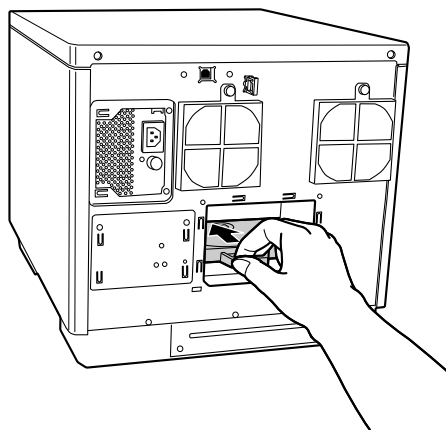

- 5** Open the disc cover.

- 6** Pull out the printer tray.

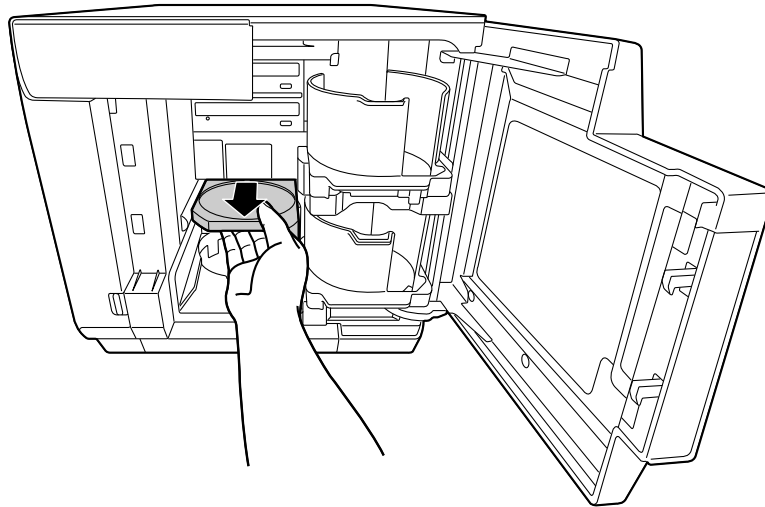

- 7** Remove the disc, and close the disc cover.
 The printer tray automatically closes when the power is turned on in Step 9.

- 8** Reattach the rear printer cover.

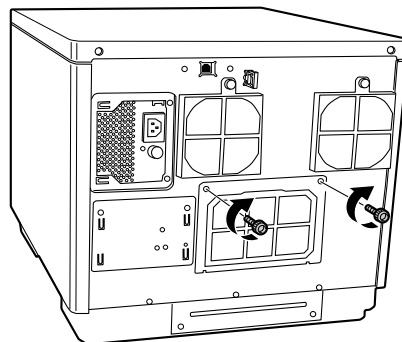

- 9** Insert the power plug into the outlet, and turn on the power.

For PP-100AP

- 1** Turn the product off.
See “Turning Off the Power” on page 20.
- 2** After the Power light goes off, unplug the power plug from the outlet.
- 3** Loosen the two screws.

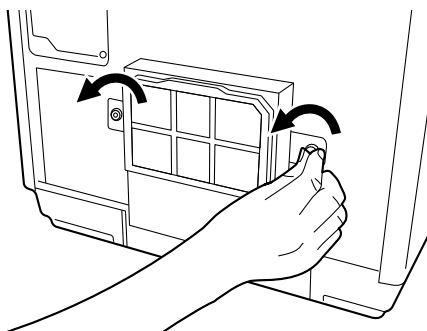

- 4** Remove the maintenance box cover.

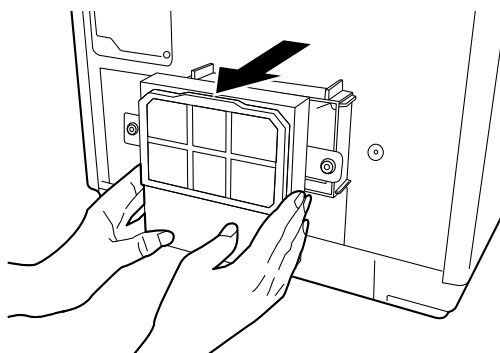

- 5** Pull out the maintenance box.

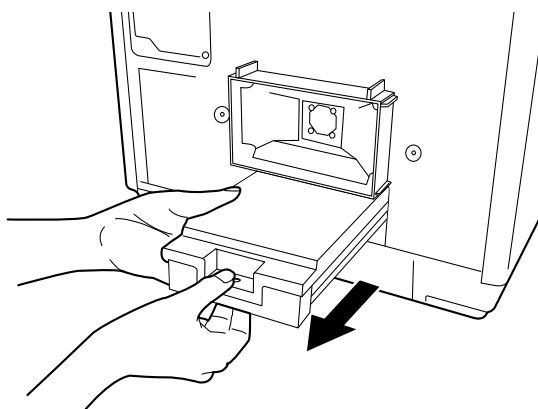

- Do not tilt the used maintenance box. Otherwise ink may leak.
- Do not touch the ink ejection port of the maintenance box or the inside of the box insertion opening of the product.

- 6 Grasp the fixture as shown in the figure below, and push the printer tray in the direction of the arrow indicated below.

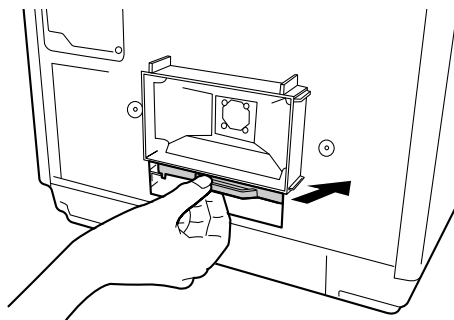

- 7 Open the disc cover.

- 8 Pull out the printer tray.

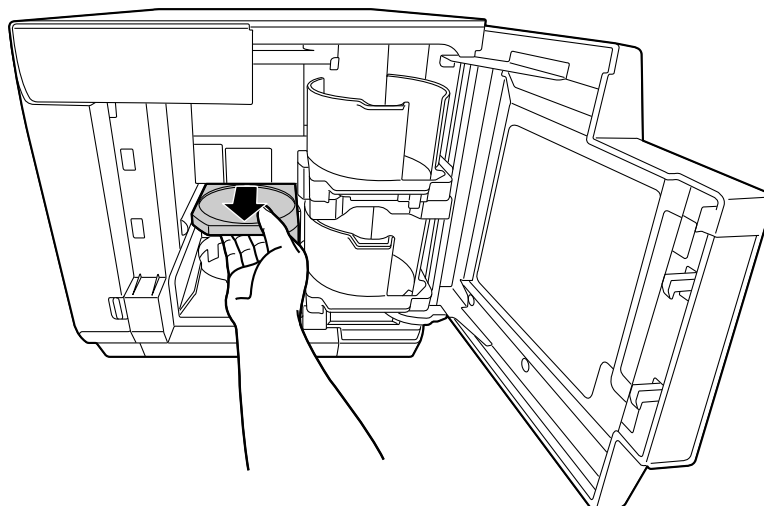

- 9 Remove the disc, and close the disc cover.

The printer tray automatically closes when the power is turned on in Step 13.

- 10 Reinstall the maintenance box.

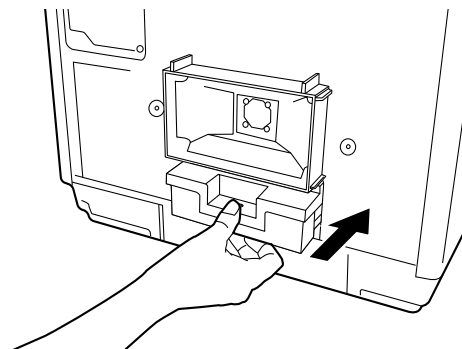

11 Reattach the maintenance box cover.

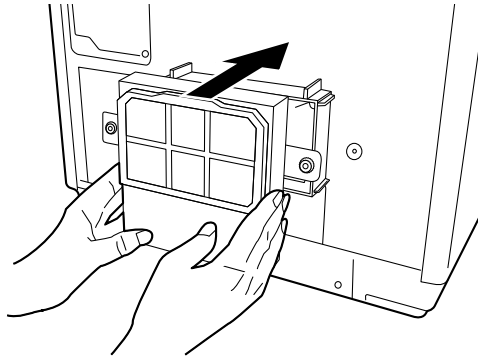

12 Tighten the two screws.

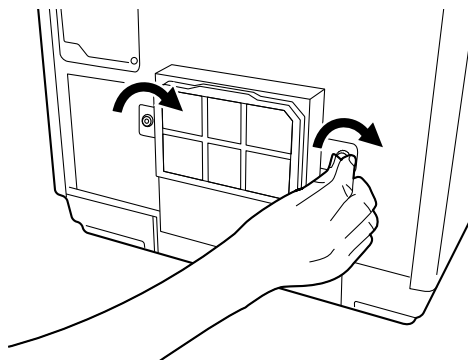

13 Insert the power plug into the outlet, and turn on the power.

Disc Recording Surface is Stained with Ink

When the disc recording surface is stained with ink, the printer tray may be dirty. Clean the printer tray by following the procedure below.

For PP-100III

- 1** Turn the product off.
See [“Turning Off the Power”](#) on page 20.
- 2** After the Power light goes off, unplug the power plug from the outlet.
- 3** Remove the two screws to remove the maintenance box cover.

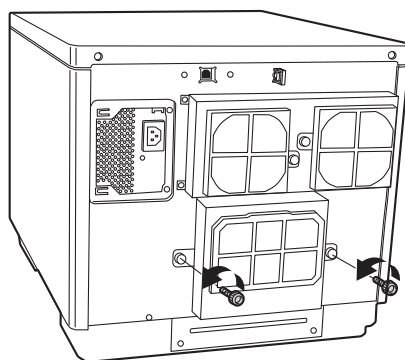

- 4** Grasp the fixture as shown in the figure below, and push the printer tray in the direction of the arrow indicated below.

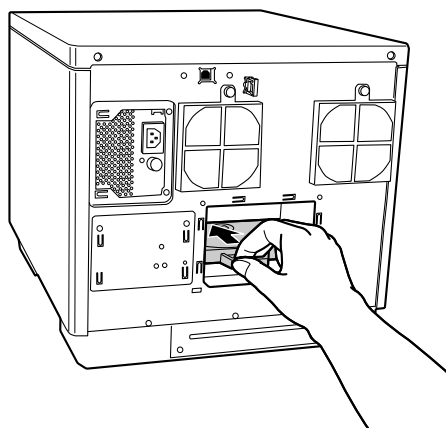

- 5** Open the disc cover.

- 6** Pull out the printer tray.

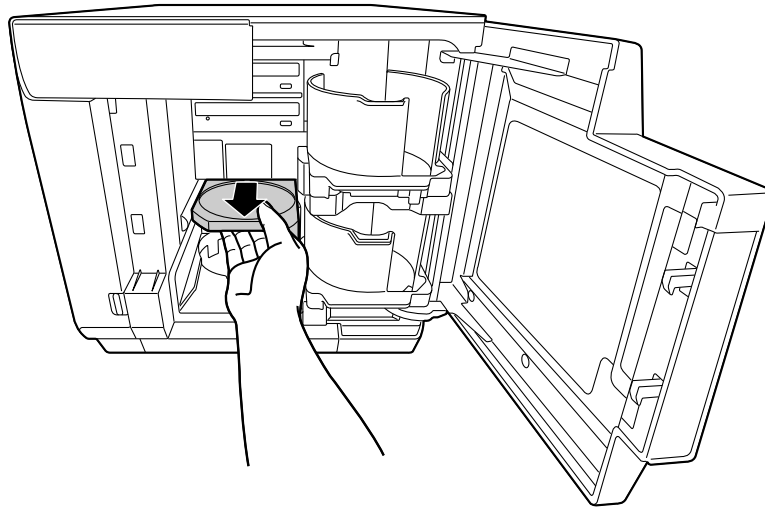

- 7** Use a soft cloth to wipe off any dirt on the printer tray.

- 8** Close the disc cover.

The printer tray automatically closes when the power is turned on in Step 10.

- 9** Reattach the maintenance box cover.

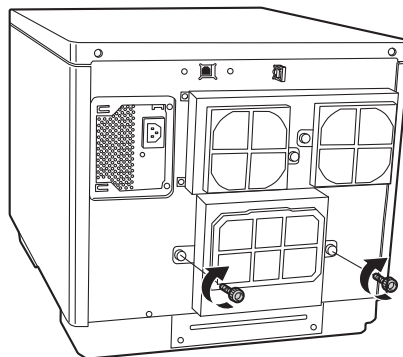

- 10** Insert the power plug into the outlet, and turn on the power.

For PP-50II

- 1** Turn the product off.
See [“Turning Off the Power”](#) on page 20.
- 2** After the Power light goes off, unplug the power plug from the outlet.
- 3** Remove the two screws to remove the rear printer cover.

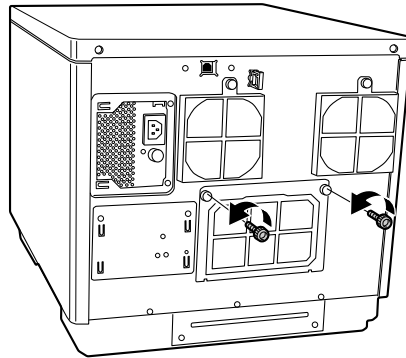

- 4** Grasp the fixture as shown in the figure below, and push the printer tray in the direction of the arrow indicated below.

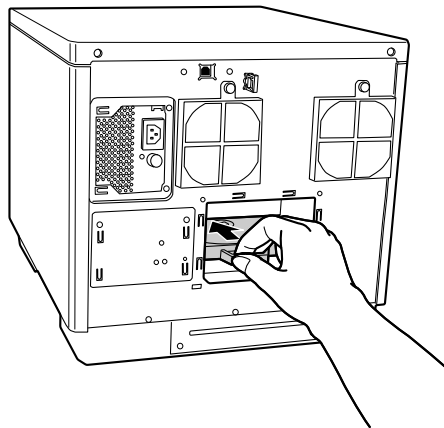

- 5** Open the disc cover.

- 6 Pull out the printer tray.

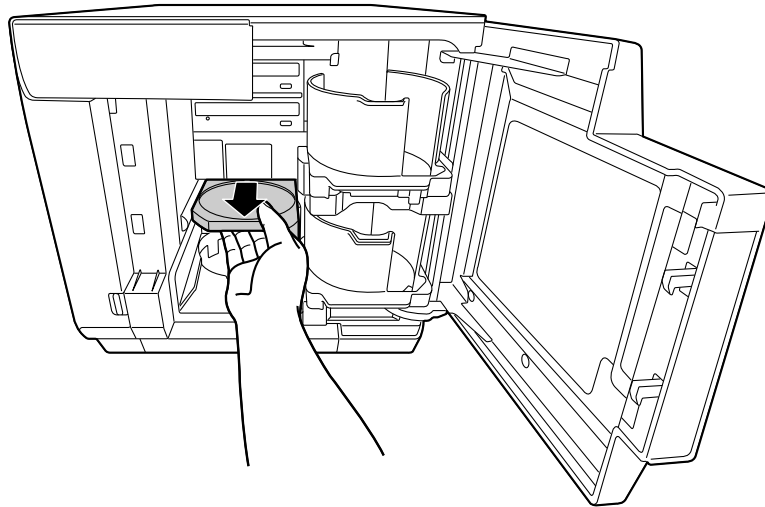

- 7 Use a soft cloth to wipe off any dirt on the printer tray.
- 8 Close the disc cover.
The printer tray automatically closes when the power is turned on in Step 10.
- 9 Reattach the rear printer cover.

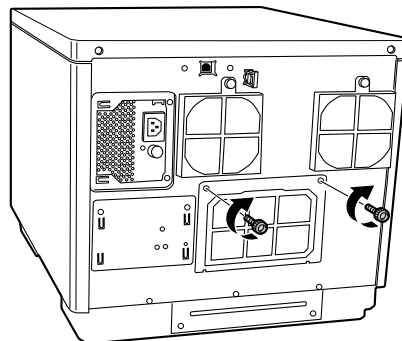

- 10 Insert the power plug into the outlet, and turn on the power.

For PP-100AP

- 1** Turn the product off.
See “Turning Off the Power” on page 20.
- 2** After the Power light goes off, unplug the power plug from the outlet.
- 3** Loosen the two screws.

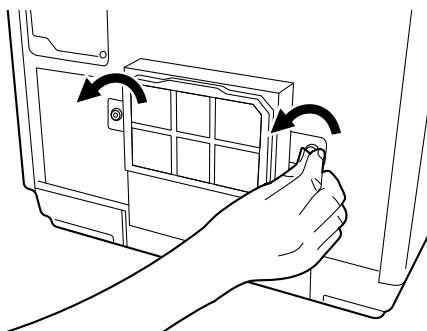

- 4** Remove the maintenance box cover.

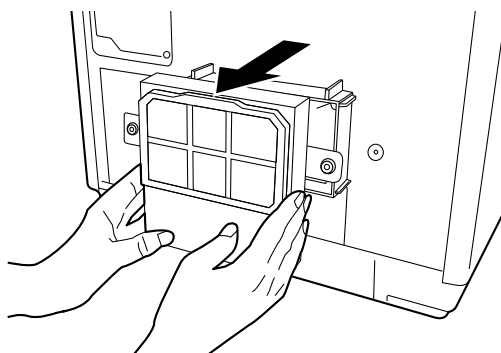

- 5** Pull out the maintenance box.

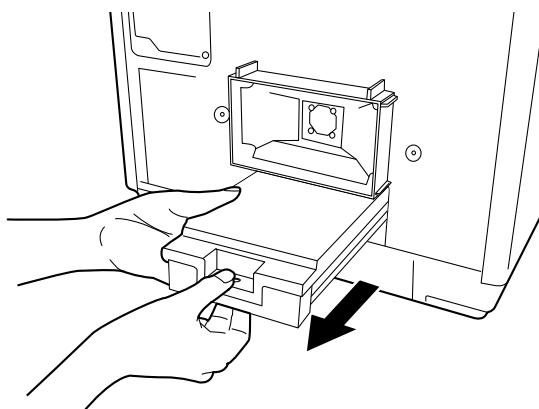

- Do not tilt the used maintenance box. Otherwise ink may leak.
- Do not touch the ink ejection port of the maintenance box or the inside of the box insertion opening of the product.

- 6 Grasp the fixture as shown in the figure below, and push the printer tray in the direction of the arrow indicated below.

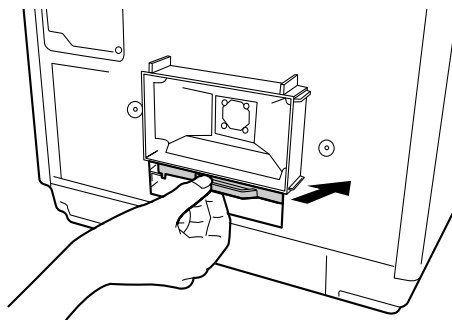

- 7 Open the disc cover.

- 8 Pull out the printer tray.

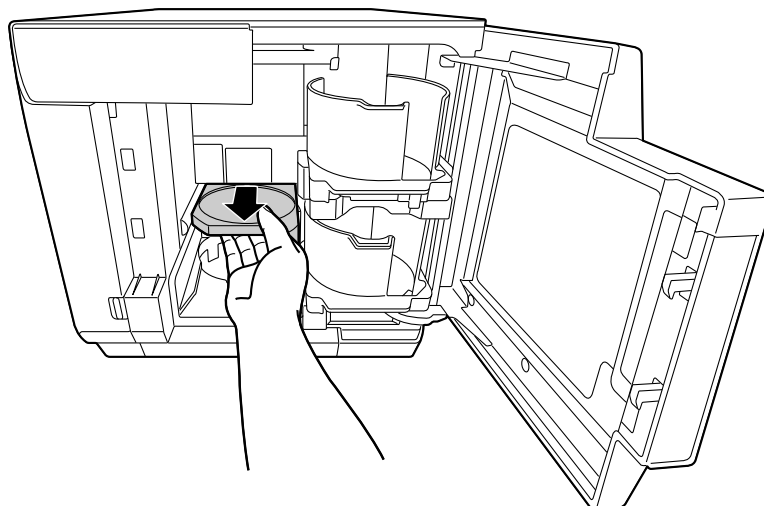

- 9 Use a soft cloth to wipe off any dirt on the printer tray.

- 10 Close the disc cover.
The printer tray automatically closes when the power is turned on in Step 14.

- 11 Reinstall the maintenance box.

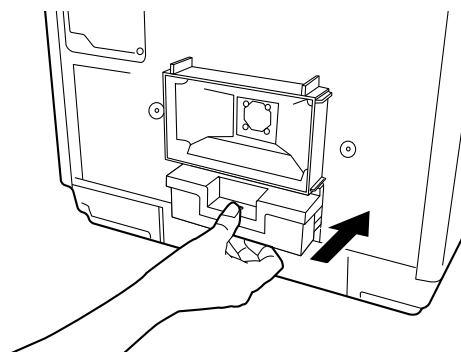

12 Reattach the maintenance box cover.

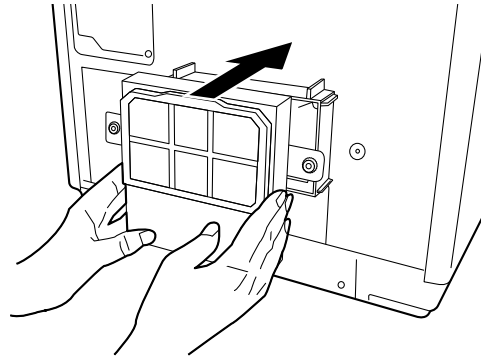

13 Tighten the two screws.

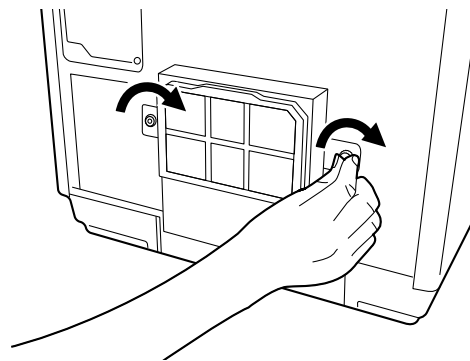

14 Insert the power plug into the outlet, and turn on the power.

Appendix

Where to get help

Before Contacting Epson

If your Epson product is not operating properly and you cannot solve the problem using the troubleshooting information in your product documentation, contact customer support services for assistance. If customer support for your area is not listed below, contact the dealer where you purchased your product.

Customer support will be able to help you much more quickly if you give them the following information:

- Product serial number
(The serial number label is usually on the back of the product.)
- Product model
- Product software version
(Click About, Version Info, or similar button in the product software.)
- Brand and model of your computer
- Your computer operating system name and version
- Names and versions of the software applications you normally use with your product

Help for Users in the United States and Canada

Contacts for information, support, and services are:

Discproducer Technical Support: 562-276-1360

Location: Epson America Inc.

Web site URL: <https://www.epson.com/support/>

This site will provide the end user with access to the latest drivers and FAQs.

Help for Users in the Europe (EMEA)

Contacts for information, support, and services are:

Web site URL: <https://www.epson-europe.com/>

Or contact your local distributor or Epson sales company.

If you need the latest drivers, FAQs, manuals, or other downloadable, access the site at:

<https://www.epson.eu/>

Help for Users in Australia

Contacts for information, support, and services are:

Epson Australia Pty Ltd

3 Talavera Road

North Ryde NSW 2113

Australia

Phone: 02-8899-3666

Fax: 02-8899-3777

If you need the latest drivers, FAQs, manuals, or other downloadable, access the site at:

<https://www.epson.com.au/>

Help for Users in Southeast Asia

Contacts for information, support, and services are:

PT Epson Indonesia

CIBIS Tower 9, 3rd floor

Cibis Business Park

Jalan T.B.Simatupang No. 2

Jakarta 12560

Tel: 021 572 3161

Fax: 021 572 4357

Helpdesk: 0807 11 37766

<https://www.epson.co.id/>

Epson Singapore Pte Ltd

1 HarbourFront Place

#03-02 HarbourFront Tower 1

Singapore 098633

Helpdesk: 6586 3111

<https://www.epson.com.sg/>

Epson Malaysia Sdn Bhd

3rd Floor, East Tower,

Wisma Consplant 1,

No.2 Jalan SS 16/4,

47500 Subang Jaya, Selangor DE,

Malaysia

Tel: 03-5628 8288

Fax: 03-5621 2088

Helpdesk: 03-5521 5888

<https://www.epson.com.my/>

Epson (Thailand) CO., Ltd.

195 Empire Tower 42nd Floor,

South Sathorn Road Yannawa

Sathorn, Bangkok 10120

Thailand,

Tel: 0-2685-9888

Fax: 0-2685-9889

Helpdesk: 0-2685-9899

<https://www.epson.co.th/>

Epson Philippines Corporation

8th Floor, Anson's Centre

#23 ADB Avenue,

Pasig City 1605, Philippines

Trunkline: 63-2 706-2609

Customer Care:

Trunkline: 63-2 706-2609 (Press 2)

Fax: 63-2 706-2663

Toll-Free No.: 1-800-1068-EPSON (37766)

<https://www.epson.com.ph/>

Product Specifications

Basic Specifications

External dimensions and weight

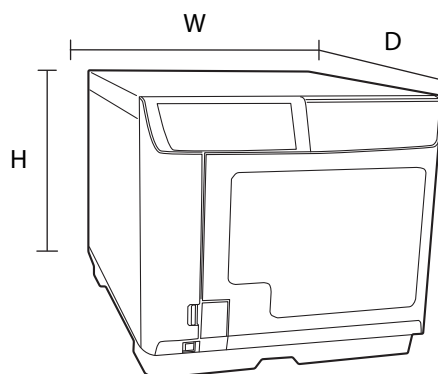

PP-100III

Item	Description
External dimensions	377 mm (W) x 493 mm (D) x 348 mm (H)
Weight	Approx. 24.0 kg (including the stackers and ink cartridges, but not including the power cord and discs)

PP-50II

Item	Description
External dimensions	377 mm (W) x 465mm (D) x 324 mm (H)
Weight	Approx. 21.0 kg (including the stackers and ink cartridges, but not including the power cord and discs)

PP-100AP

Item	Description
External dimensions	377 mm (W) x 489 mm (D) x 348 mm (H)
Weight	Approx. 22.0 kg (including the stackers and ink cartridges, but not including the power cord and discs)



Since this product uses galvanized sheet metal, rusting may occur at the edges, but this will not harm the functionality of the product.

Job processing

Job processing speed differs depending on the environment.



Depending on the operating environment and discs used, the writing speed may become slower than the set speed. (This is to ensure recording quality is maintained.)

PP-100III

Item		Description
Write and print	CD	30 discs per hour Conditions: When using Epson specified CD-Rs, drive speed of 40x, writing data of 600 MB, and speed/bidirectional printing
	DVD	15 discs per hour Conditions: When using Epson specified DVD-Rs, drive speed of 12x, writing data of 3.8 GB, and speed/bidirectional printing

PP-50II

Item		Description
Write and print	CD	15 discs per hour Conditions: When using Epson specified CD-Rs, drive speed of 40x, writing data of 600 MB, and speed/bidirectional printing
	DVD	8 discs per hour Conditions: When using Epson specified DVD-Rs, drive speed of 12x, writing data of 3.8 GB, and speed/bidirectional printing

PP-100AP

Item		Description
Print only	Print Mode Setting (Quality/Speed): 3	95 discs per hour Condition: When bidirectional printing
	Print Mode Setting (Quality/Speed): 2	75 discs per hour Condition: When bidirectional printing
	Print Mode Setting (Quality/Speed): 1	50 discs per hour Condition: When bidirectional printing

Number of connectable products

Item			Description
Number of products that can be connected to one PC*	Write and print	CD	3
		DVD	2
	Print only		6

*: Guaranteed number of products that can process jobs published from one connected PC at the same time.

More than one PP-50II cannot be connected to one PC.

Printing specifications

Item			Description
Printing method			On demand inkjet
Number of head nozzles	Black		180 nozzles
	Cyan		180 nozzles
	Magenta		180 nozzles
	Yellow		180 nozzles
	Light cyan		180 nozzles
	Light magenta		180 nozzles
Printing resolution	PP-100III/ PP-50II	Print Mode Setting (Quality/Speed): 1	1,440 x 1,440 dpi
		Print Mode Setting (Quality/Speed): 2	1,440 x 720 dpi
	PP-100AP	Print Mode Setting (Quality/Speed): 1	1,440 x 1,440 dpi
		Print Mode Setting (Quality/Speed): 2	1,440 x 720 dpi
		Print Mode Setting (Quality/Speed): 3	720 x 720 dpi
Printing direction			Bidirectional, unidirectional

dpi: number of dots every 25.4 mm (dots per inch)

Ink cartridge

Item		Description	
Form		Separate ink cartridge for each color	
Color		Black, cyan, magenta, yellow, light cyan, light magenta	
Recommended expiration date		Use within the expiration date written on each individual packaging box. Use within 6 months of opening the package.	
Temperature	When stored packaged individually	-20°C~40°C	Within 1 month at 40°C
	When installed in the product	-20°C~50°C	Within 1 month at 50°C
	When transported packaged individually	-20°C~60°C	Within 5 days at 60°C
Dimensions		42.0 mm (W) x 83.0 mm (D) x 26.4 mm (H)	
Ink		Dye-based ink	

Drive specifications (Only for PP-100III/PP-50II)

Item		Description
Number of drives installed	PP-100III	2 drives
	PP-50II	1 drive
Loading type		Tray
Write speed	CD-R	40x/32x/24x/16x/10x/4x
	DVD-R	12x/8x/6x/4x/2.4x/2x/1x
	DVD+R	12x/8x/6x/4x/2.4x/2x/1x
	DVD-R DL	8x/6x/4x/2.4x/2x
	DVD+R DL	8x/6x/4x/2.4x/2x



- If you select 2.4x for DVD-R/DVD-R DL, write speed will be set to 2x.
- If you select 2x for DVD+R/DVD+R DL, write speed will be set to 2.4x.
- CD/DVD discs created with this product's drive may not be able to be recognized, played, and read depending on the compatibility of the drive or player.
- Do not subject the product to vibration or impacts while a disc is being read or written. The drive may malfunction, or the disc may become unable to be played.
- Do not insert a flat-tip screwdriver, clip or other foreign object into the CD/DVD drive. Doing so may result in a malfunction.
- Depending on the operating environment and discs used, the writing speed may become slower than the set speed. (This is to ensure recording quality is maintained.)

Electrical specifications

Item		Description		
		PP-100III	PP-50II	PP-100AP
Rated voltage		AC 100 to 240 V		
Rated frequency		50 to 60 Hz		
Rated current		1.0 A		
Power consumption	Average during operation	Approx. 52W	Approx. 40 W	Approx. 30 W
	Average during standby	Approx. 27W	Approx. 28 W	Approx. 20 W
Power cord		power cord (supplied with product)		

Environmental conditions

Item		Description	
Temperature	During operation	10 ~ 35 °C (50 to 95 °F)	
	During storage	-20 ~ 40 °C (-4 to 104 °F)	
	During transportation	-20 ~ 60°C {-4 to 140°F} No more than 1 month at 40°C {104°F}, No more than 120 hours at 60°C {140°F}	
Humidity	During operation	20 ~ 80%RH	No condensation
	During storage	5 ~ 85%RH	
	During transportation	5 ~ 85%RH	
Operating range	During operation		
	During storage*		
	During transportation*		
Elevation	2000 m or less		

*: PP-100III/PP-50II

Interfaces

Item	Description
Compliance	For the PP-100III: USB 3.0 or USB 2.0 For the PP-50II/PP-100AP: USB 2.0
Communication speed	<ul style="list-style-type: none">• USB 3.0: SuperSpeed (5 Gbps)• USB 2.0: Hi-Speed (480 Mbps)

Consumables and Options

To purchase consumables and options, check with the dealer where you purchased your product or access one of the following URLs:

[https://www.epson.com/support/\(United States and Canada\)](https://www.epson.com/support/(United%20States%20and%20Canada))

<https://www.epson-europe.com/> (Europe)

<https://www.epson.com.au/> (Australia)

Ink cartridges and Maintenance Box

You can use the following ink cartridges and the maintenance box with Discproducer series products:

Part		Part numbers
Ink cartridge	Cyan	PJIC1/PJIC7(C)
	Light Cyan	PJIC2/PJIC7(LC)
	Light Magenta	PJIC3/PJIC7(LM)
	Magenta	PJIC4/PJIC7(M)
	Yellow	PJIC5/PJIC7(Y)
	Black	PJIC6/PJIC7(K)
Maintenance box (only for PP-100III and PP-100AP)		PMJB100

Discs

Epson offers the specified CD-R and DVD-R discs for all your printing needs.

Drive (Only for PP-100III)

You can use the following exclusive drive with PP-100III.

- BDE-PR1EP
- BDE-PR1EP2
- BDE-PR1EP3



Do not use other drives than the Epson exclusive optional drive. Otherwise the PP-100III and the drive may be damaged.