

# EPSON

## PRODUCT INFORMATION GUIDE

### UPDATE FOR SD PRODUCTS

1/23/02

This package provides a POS printer product section to be added to the *EPSON System Device Product Information Guide*. The table of contents of this section is listed below.

### EPSON TM-L90

Accessories .....	1
Printer Specifications .....	1
Reliability .....	1
Electrical Characteristics .....	2
Environmental Conditions .....	2
Safety .....	2
Buffer Sizes .....	2
Control Panel .....	2
Loading Paper .....	2
Installing the Paper Roll Spacer .....	2
Testing the Printer .....	3
Removing Jammed Paper .....	3
DIP Switches .....	3
Memory Switches .....	4
Error LED Codes .....	4
Related Documentation .....	4

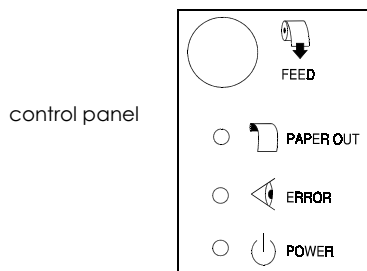
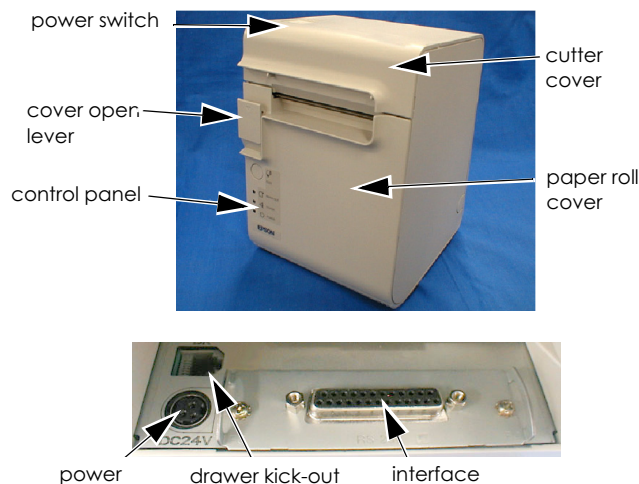

Printable area 2.83" {72 mm} for 80 mm paper  
 Print direction unidirectional with friction feed  
 Paper feed speed 5.91"/sec. {150 mm/sec.} maximum (continuous paper feed)  
 Print speed single-color:  
     normal printing mode — 4.72"/sec. {120 mm/sec.} maximum  
     high-speed mode — 5.91"/sec. {150 mm/sec.} maximum  
     printing a 2-dimensional bar code — 3.54"/sec. {90/mm/sec.} maximum  
 two-color: 3.94"/sec.  
     1.97"/sec. {50 mm/sec.} maximum

Characters per line 48 (using font A on 3.15" paper)

Character structure

Font A: 12 × 24 (with 2-dot spacing)  
 Font B: 9 × 17 (with 2-dot spacing)  
         10 × 24 (with 2-dot spacing)  
 Font C: 8 × 16 (with 2-dot spacing)

Character sets alphanumeric: 95 characters;  
 international: 37 characters;  
 extended graphics: 128 characters × 11 pages (including a space page)

Autocutter partial or full cut option set by dealer  
 Dimensions 8" × 5.5" × 5.8" {203 × 140 × 148 mm} H × W × D

Weight approx. 4.2 lb {1.9 kg}

Interfaces

Standard IEEE-1284 parallel or USB

Accessories

Paper

Thermal paper	Type	Size
Single-color	Roll: ENTPD	79.5 ± 0.5 mm {3.13 ± 0.02"} 59.5 ± 0.5 mm {2.34 ± 0.02"} 37.5 ± 0.5 mm {1.48 ± 0.02"}
	ENTPE (thick)	
	Label: ENTLA	
Two-color	Roll: ENTPC Label: ENTLB	

Other options

Option	Model	Part number
Wall hanging bracket	WH-10	C32C845010
Power supply	PS-170	C32C825321
Power supply (power-saving type)	PS-180	C32C825343

Printer Specifications

Printing

Printing method thermal line printing (single and two-color)  
 Dot density 203 dpi × 203 dpi  
 Paper width 3.15" {80 mm} (default) or variable with an optional paper roll spacer

Reliability

Life

Mechanism single-color: 20 million lines (ENTPD)  
                                   10 million lines (ENTPE)  
                                   1 million lines (ENTLA)  
 two-color: 10 million lines (ENTPC)  
                                   500,000 lines (ENTLB)

Thermal head 150 million pulses  
 Autocutter: 2 million cuts (regular receipts)  
                   1.2 million cuts (62 μm paper)  
                   1 million cuts (labels or thick paper under 145 μm)  
 MTBF: 360,000 hours (single-color on receipts)  
 MCBF: 70 million lines (single-color on receipts)

## Electrical Characteristics

Supply voltage	+24 V ± 7% (using the PS-170 or PS-180)
Current consumption (approximate, at room temperature)	
Normal	Mean: 1.7 A Peak: 7.7 A
Low-power	Mean: 1 A
Standby	Mean: 0.1 A

## Environmental Conditions

Temperature:	Operating:	41 ~ 113°F (5 ~ 45°C)
	Storage:	14 ~ 122°F (-10 ~ 50°C)
Humidity	Operating:	10 ~ 90% RH
	Storage:	10 ~ 90% RH (except paper)

## Safety

EMI FCC/ICES-003 Class A

Safety standards UL 1950  
CSA C22.2 No. 950  
TÜV (EN 60950)

(Tested using the EPSON PS-170 and PS-180.)

## Buffer Sizes

Receive	4KB or 45 bytes, selectable via memory switch
User	12KB
Macro	2KB
NV (non-volatile) bit image	0 through 384KB
NV user	1KB through 192KB
Page mode area	106KB

## Control Panel

### Button and LEDs

#### FEED BUTTON

Feeds roll paper or starts execution of a self-test or a macro.

#### POWER LED

On when the power is on. Flashes during an operation.

#### ERROR LED

Off when the printer is online, lights when the printer is offline or feeding paper, and flashes when an error occurs.

#### PAPER OUT LED

On when the printer is out, or nearly out, of roll paper. Flashes during standby for printing a self-test or running a macro (when the macro execution command is used).

## Loading Paper

Use only paper rolls and labels that meet specifications.

When using the printer horizontally, peel the backing sheet off the paper exit guide and attach it as shown to prevent paper cut by the autocutter from falling into the printer.

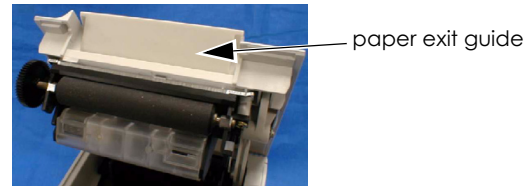

If you use roll paper smaller than the specifications, but with an inside core diameter of at least 1" and an outside core diameter of at least 1.25", do not attach the paper exit guide. Otherwise, a paper jam may occur.

1. Open the paper roll cover using the cover open lever.
2. Insert a paper roll and pull out a small amount of paper, aligning it with the guide, as shown below.

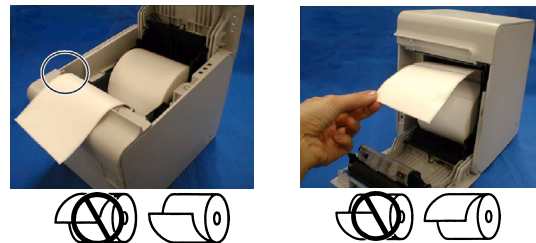

3. Close the cover and tear off the extra paper by pulling it toward the front of the printer.

 **Note:** Push down on the middle of the cover to close it completely.

## Installing the Paper Roll Spacer

To use paper rolls that are 38 or 70 mm {1.5 or 2.76"} wide, install the paper roll spacer, as described below.

 **Note:** Do not change the paper width from narrow to wide on a used printer, or printing and paper-cutting problems may occur. You can always change the paper width from wide to narrow.

1. For rolls from 61 to 70 mm {2.4 to 2.76"}, break tabs off the spacer. (For 38 to 61 mm paper, you can leave tabs on.)

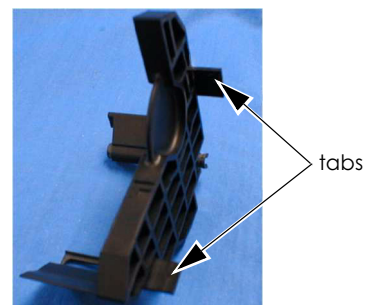

2. Insert the paper roll spacer so that the front edge goes into the notch and down to the shaft, as shown below.

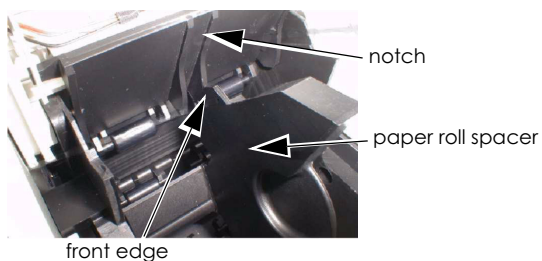

3. Push the paper roll spacer until you feel it click onto the shaft.

 **Note:** Check that the paper roll spacer slides left and right smoothly.

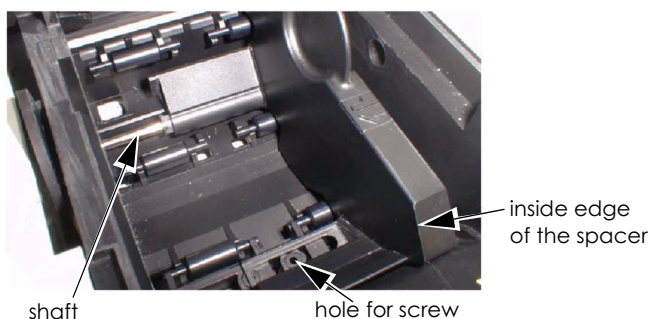

4. Slide the paper roll spacer to the appropriate width, as shown above. You can use the measurement printed inside the printer. Align the inside edge of the spacer with the desired measurement.
5. Insert the screw included with the spacer into the hole indicated above and tighten it. (Even if you can see two holes, this is the only one to put the screw in.)
6. Follow the instructions in this guide to set the memory switch for the desired paper width.

## Testing the Printer

Follow these steps to run a self-test:

1. Load the paper roll and close the paper roll cover.
2. Hold down the FEED button, and turn on the printer. When printing starts, release the FEED button. The printer settings are printed.
3. The PAPER OUT light starts to flash when the status has been printed. Press the FEED button to start the test.
4. After the printer prints the lines for the self-test, it prints **\*\*\* completed \*\*\***. The printer is ready to receive data as soon as it completes the self-test.

 **Note:** To pause the self-test manually, press the FEED button. Press FEED again to continue the self-test.

## Removing Jammed Paper

-  **CAUTION:**
- Do not touch the thermal head or radiation plate, because they can be very hot after printing.
  - Do not let metal objects come into contact with the thermal head. Metal can damage the head.

1. Power off the unit, open the paper roll cover, and remove the jammed paper.
2. If you cannot open the paper roll cover, paper is jammed in the autocutter. Follow the steps under “Clearing the Autocutter” below.

## Clearing the Autocutter

1. Lift up and remove the cutter cover by inserting a flathead screwdriver into the slots on each side of the main case and spreading the case in the direction of the arrows.

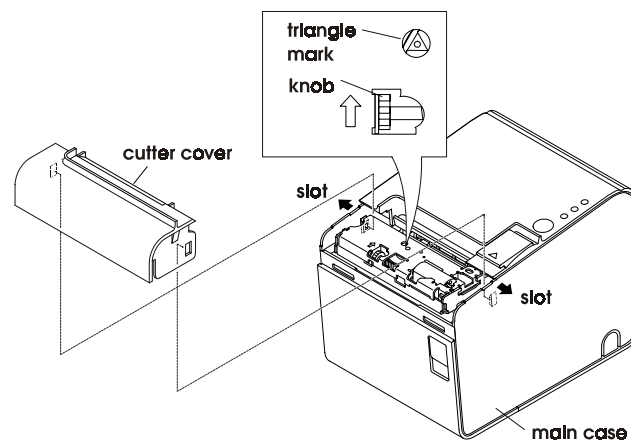

2. Rotate the autocutter knob in the direction of the arrow to return the cutter blade to the normal position. (A triangle mark shows through the window in the autocutter frame.)
3. Open the paper roll cover, re-install the cutter cover, and close the paper roll cover.

## DIP Switches

### Serial interface

Bank 1	Function	ON	OFF
1	Power button function	Enabled	Disabled
2	Interface setting method	DIP switch	Memory switch
3	Handshaking	XON/XOFF	DTR/DSR
4	Word length	7 bits	8 bits
5	Parity check	Yes	No
6	Parity selection	Even	Odd
7 and 8	Transmission speed	See table below.	

Transmission speed	Switch 1-7	Switch 1-8
2400	ON	ON
4800	OFF	ON
9600	ON	OFF
19200	OFF	OFF

Bank 2	Function	ON	OFF
1	Reserved	—	Fixed to off

**Parallel interface**

Bank 1	Function	ON	OFF
1	Power button function	Disabled	Enabled
2 ~ 8	Undefined	—	—

Bank 2	Function	ON	OFF
1	Reserved	—	Fixed to off

**Memory Switches**

**Settings Made at the Printer**

To set the memory switches, follow the steps below.

1. Be sure roll paper is installed. Open the paper roll cover and turn on the power while pressing the FEED button.
2. Press the FEED button again twice.
3. Close the paper roll cover. The printer prints instructions for items you can set on the printer manually.

**Memory Switch Setup**

Set up items









- 0. No Change
- 1. Auto Cutter
- 2. Paper, Print Density
- 3. Basic Serial Interface Settings
- 4. Advanced Interface Settings
- 6. Interface Reset Signal
- 7. Paper Width
- 12. TM-T88II Mode, Power ON Status
- 13 or more No Change

Please select setup item by executing the following operations.

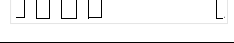
- (1) Cover open
- (2) Push the same times PAPER FEED button as the menu number
- (3) Cover close

4. Follow the instructions above to change the switch you want to set.
5. After you have finished making settings, the printer saves the settings, initializes, and becomes ready to print.

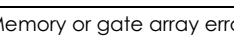
**Error LED Codes**

LED pattern	Solution
Autocutter error 	Check for paper jam in the autocutter. If problem continues, contact your servicer.
Drive circuit error 	Check that the interface board is installed correctly. If problem continues, contact your servicer.
CPU execution error 	Contact your servicer.
Low-voltage error 	Replace power supply unit. If problem continues, contact your servicer.
High-voltage error 	Replace power supply unit. If problem continues, contact your servicer.
Paper layout error 	<ol style="list-style-type: none"> <li>① Be sure to use paper or labels that meet the specifications.</li> <li>② Check for a jam of the paper or labels and clear if necessary.</li> <li>③ Check the LED holder assembly and black mark paper detector for dust or dirt.</li> </ol> If problem continues, contact your servicer.
Memory or gate array error 	Contact your servicer.
Paper roll cover open error (set as an error that can possibly recover) 	Close the paper roll cover. If this error is set with Msw 8-8 as an error that can possibly recover, turn the printer off, and turn it back on again.
<ol style="list-style-type: none"> <li>① Print head temperature error</li> <li>② Paper roll cover open error (set as an error that automatically recovers)</li> <li>③ Paper layout error</li> </ol> 	<ol style="list-style-type: none"> <li>① Wait for print head temperature to drop. Then, the printer will recover automatically.</li> <li>② Replace the autocutter unit and close the roll paper cover. Then, if this error is set as an automatically recoverable error with Msw 8-8, the printer recovers automatically.</li> <li>③ Load proper label or black mark paper. Then, the printer will recover automatically.</li> </ol> If problem continues, contact your servicer.

**Related Documentation**

- EPSON TM-L90 Service Manual
- EPSON TM-L90 Parts Price List
- EPSON TM-L90 Operator's Manual
- EPSON TM-L90 Specification