

Media

Media name	Size	Part number
EPSON 360 dpi Ink Jet Paper	Letter A4 Super A3/B	S041060 S041059 S041066
EPSON High Quality Ink Jet Paper	Letter A4	S041111 S041117
EPSON Photo Quality Ink Jet Paper	Letter A4 Legal B Super A3/B A2	S041062 S041061 S041067, S041048 S041070 S041069 S041079
EPSON Photo Quality Glossy Paper	A4 Letter A2 Super A3/B	S041126 S041124 S041123 S041133
EPSON Photo Quality Glossy Film	A4 Letter A6 B Super A3/B	S041071 S041072 S041107 S041075 S041074
EPSON Ink Jet Transparencies	A4 Letter	S041063 S041064
EPSON Photo Quality Ink Jet Cards	A6 8 × 10	S041054 S041122
EPSON Iron-On Transfer Paper	Letter Super A3/B	SE41001, SE41002 SE41003
EPSON Photo Quality Self Adhesive Sheets	A4	S041106
EPSON Photo Quality Banner Paper	A2 × 15 m roll (16.5 inches × 49.2 ft)	S041102
EPSON Ink Jet Canvas Cloth	A2 × 3 m roll (16.5 inches × 9.8 ft)	S041132
EPSON Ink Jet Back Light Film	A2 A3	S041130 S041131

Optional Interfaces

You can install one of the following EPSON interface boards in your printer:

Type of interface board	Model number	Compatibility
Serial	C823051	PC
32KB serial	C832071	PC
32KB parallel	C823101	PC
Twinax	C823151	PC
Coax	C823141	PC
LocalTalk®	C823121	Macintosh
Ethernet	C823461	Macintosh/PC
Type B bidirectional parallel	C823452	PC

Accessories

Ink Cartridges

Use these EPSON ink cartridges before the expiration date on the package.

Cartridge	Part number
Black ink cartridge	S020118
Cyan ink cartridge	S020130
Magenta ink cartridge	S020126
Yellow ink cartridge	S020122

Printer Specifications

Printing

Printing method On-demand ink jet
 Nozzle configuration Monochrome (black) 128 nozzles
 Color (cyan, magenta, yellow) 192 nozzles, 64 of each color

Printable columns and printing speeds

Character pitch (characters per inch)	Printing column	Printing speed (characters per second)	
		Draft	LQ
10	161	800	400
12	193	960	480
15	242	1200	600
17 (10 condensed)	276	1378	684
20 (12 condensed)	322	1600	800

Resolution Maximum 1440 dpi × 720 dpi
 Print direction Bidirectional with logic seeking for text and graphics. (Auto print direction can be set in the default-setting mode.)
 Control code ESC/P 2 and expanded raster graphics code
 IBM XL24E
 Line spacing 1/6 inch (default) programmable in 1/8-inch or 1/360-inch increments
 Paper feed speed 100 milliseconds per 1/3-inch line
 Input buffer 64KB

Fonts

Bitmap fonts

Font	10 cpi	12 cpi	15 cpi	Proportional
EPSON Roman	x	x	x	x
EPSON Sans Serif	x	x	x	x
EPSON Courier	x	x	x	—
EPSON Prestige	x	x	x	—
EPSON Script	x	x	x	—

cpi=characters per inch.

Select other font/pitch combinations using the ESC/P 2 commands.

Scalable fonts

Font	Minimum point size	Maximum point size	Increments
EPSON Roman	8	32	2
EPSON Sans Serif	8	32	2
EPSON Roman T	8	32	2
EPSON Sans Serif H	8	32	2

Note:

The printer always uses the fonts you selected with your software application. You need to use the printer's internal fonts only if your application doesn't allow you to select fonts.

Character tables 1 italic and 26 graphics character tables

Character sets 14 international character sets and 1 legal character set

Note:

Character tables are selected with default-setting mode or by using software commands.

Paper

Paper type	Size	Paper types	Thickness	Weight
Single sheets	Letter (8.5 × 11 inches) A4 (210 × 297 mm) A5 (148 × 210 mm) Legal (8.5 × 14 inches) Half Letter (5.5 × 8.5 inches) Executive (7.5 × 10 inches) A2 (420 × 594 mm) Super A3/B (13 × 19 inches) A3 (297 × 420 mm) Ledger (11 × 17 inches) US C (17 × 22 inches) B3 (364 × 514 mm) B4 (257 × 364 mm) B5 (182 × 257 mm)	Plain bond paper and special ink jet papers distributed by EPSON	0.0025 to 0.004 inch (0.065 to 0.11 mm)	Built-in sheet feeder: 17 to 24 lb (64 to 90 g/m ²) Manual feeder: 14 to 24 lb (52 to 90 g/m ²)
Transparencies and Glossy film	Letter (8.5 × 11 inches) A4 (210 × 297 mm) A6 (105 × 148 mm, glossy film only) Super A3/B (13 × 19 inches, glossy film only)	Transparencies and glossy film distributed by EPSON	0.005 to 0.006 inch (0.13 to 0.15 mm)	—
Glossy paper	Letter (8.5 × 11 inches) A2 (420 × 594 mm) A4 (210 × 297 mm)	Glossy paper distributed by EPSON	0.0066 to 0.0070 inch (0.17 to 0.18 mm)	—
Photo quality self adhesive sheets	A4 (210 × 297 mm)	Self adhesive sheets distributed by EPSON	0.0079 inch (0.2 mm) maximum	—
Envelopes	No. 109.5 × 4.1 inches (240 × 104 mm) DL8.7 × 4.3 inches (220 × 110 mm) C59 × 6.4 inches (229 × 162 mm)	Plain bond paper or air mail paper	0.006 to 0.02 inch (0.16 to 0.52 mm)	12 to 24 lb (45 to 90 g/m ²)
Index (ink jet) cards	A6 (105 × 148 mm) 8 × 10 inches (203 × 254 mm)	Ink jet cards distributed by EPSON	0.0091 inch (0.23 mm) maximum	50 lb (188 g/m ²)
Canvas cloth	16.5 × 9.8 ft (420 mm × 3 m)	Canvas cloth distributed by EPSON	—	—
Roll (banner) paper	8.3 to 17 inches × 49.2 ft (210 to 432 mm × 15 m)	Roll banner paper distributed by EPSON	0.003 to 0.004 inch (0.08 to 0.1 mm)	17 to 22 lb (64 to 82 g/m ²)
Back light film	A2 (420 × 594 mm)	Back light film distributed by EPSON	0.0051 to 0.0055 inch (0.13 to 0.14 mm)	—
Continuous paper	Minimum size each sheet: 4 to 16 × 4 inches (101.6 to 406.4 × 101.6 mm)	Plain paper	0.0025 to 0.0039 inch (0.065 to 0.1 mm)	14 to 22 lb (52 to 82 g/m ²)
Continuous label paper	Minimum size each backing sheet: 4 to 16 × 4 inches (101.6 to 406.4 × 101.6 mm) Minimum label size: 2.5 × 0.94 inches (63.5 × 23.9 mm)	Plain continuous label paper	Maximum total thickness: 0.0079 inch (0.2 mm) Maximum label thickness: 0.0047 inch (0.12 mm)	—

Note:

Since the quality of any particular brand or type of paper may be changed by the manufacturer at any time, EPSON cannot attest to the quality of any non-EPSON brand or type of paper. Always test samples of paper stock before purchasing large quantities or printing large jobs.

Poor quality paper may reduce print quality and cause paper jams and other problems. If you encounter problems, switch to a higher grade of paper.

Ink jet paper, envelopes, glossy film, glossy paper, transparencies, self adhesive sheets, back light film, and canvas cloth are usable only under these conditions:

Temperature: 59 to 77 °F (15 to 25 °C)
Humidity: 40 to 60% RH

EPSON Photo Quality Glossy Film and Photo Quality Self Adhesive Sheets should be stored under these conditions:

Temperature: 59 to 86 °F (15 to 30 °C)
Humidity: 20 to 60% RH

Printable areas

Single sheets and index cards

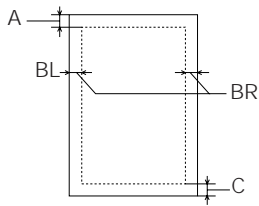

- A: The minimum top margin is 0.12 inch (3.0 mm).
- BL: The minimum left margin is 0.12 inch (3.0 mm); except for A3 landscape, A2 portrait, US B landscape, and US C portrait, which are 0.2 inch (5 mm).
- BR: The minimum right margin is 0.12 inch (3.0 mm); except for A3 landscape and A2 portrait, which are 0.2 inch (5 mm), and US B landscape and US C portrait, which are 0.43 inch (11 mm).
- C: The minimum bottom margin is 0.55 inch (14.0 mm).

Note:
The maximum printable width is 16 inches (410 mm) regardless of the paper size or feeder you use.

Envelopes

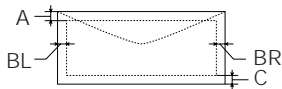

- A: The minimum top margin is 0.33 inch (8.5 mm).
- BL, BR: The minimum left and right margins are 0.12 inch (3.0 mm).
- C: The minimum bottom margin is 0.55 inch (14.0 mm).

Continuous paper

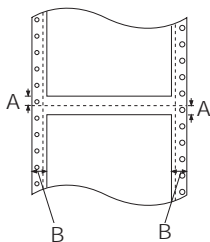

- A: The minimum top and bottom margins above and below the perforations are 0.35 inch (9.0 mm).
- B: The minimum right and left margins are 0.51 inch (13 mm).

Note:
The maximum printable width is 15 inches (381 mm).

Ink Cartridges

Specification	Black (S020118)	Cyan (S020130)	Magenta (S020126)	Yellow (S020122)
Print capacity*	3800 pages/ A4 (ISO/IEC 10561 Letter Pattern at 360 dpi)	2100 pages (A4, 360 dpi, 5% duty each color)		
Cartridge life	2 years from production date, if unopened			
Storage temperature	-22 to 104 °F (-30 to 40 °C) 1 month at 104 °F (40 °C)			
Transit temperature	-22 to 122 °F (-30 to 50 °C) 1 month at 104 °F (40 °C) 120 hours at 122 °F (50 °C)	-22 to 140 °F (-30 to 60 °C) 1 month at 104 °F (40 °C) 120 hours at 122 °F (50 °C)		
Freezing temperature**	3.2 °F (-16 °C)	-1.3 °F (-18.5 °C)	-5.8 °F (-21 °C)	-0.4 °F (-18 °C)
Dimensions	2.0 (W) × 5.5 (D) × 4.2 (H) inches 25.1 (W) × 139.6 (D) × 105.3 (H) mm			

* The print capacity may vary, depending on how often you clean the print head.

** It thaws and is usable after approximately 3 hours at 77 °F (25 °C).







Caution:
To ensure good results, use genuine EPSON ink cartridges. Other products may cause damage to your printer not covered by EPSON's warranty.

Don't use an ink cartridge if the date on the package has expired.







Mechanical

Paper feed method	Friction, tractor feeder
Paper path	Sheet feeder (paper tray), front entry Manual feeder, rear entry Tractor feeder, rear entry
Sheet feeder capacity	100 sheets of 17 lb (64 g/m ²) paper
Total print volume	75,000 pages (A3, text only)
Dimensions	Width 31.0 inches (810 mm) Depth 22.3 inches (565 mm, maximum) Height 9.4 inches (240 mm) Weight 37.8 lb (17.2 kg) without the ink cartridges

Lights

Operate	The Operate light is on when the printer is on. When the Operate light flashes, the printer is receiving data. It may also flash with other lights during certain operations or error conditions.
Paper Out 	When the Paper Out light comes on, your paper ran out or is loaded incorrectly, or the paper-release lever is set to the wrong position. Load paper, check the lever position, and then press the Pause or Load/Eject button to turn off the light. When the Paper Out light flashes, you have a paper jam. Turn off the printer and gently pull out all jammed paper and reload the paper.
Ink Out  Yellow  Magenta  Cyan  Black	When an Ink Out light flashes, your ink supply is low. Make sure you have a replacement cartridge. When an Ink Out light comes on, you need to replace the ink cartridge.
Pause	When the Pause light is on, printing is paused. Press the Pause button to resume. When the Pause light flashes, your printer is charging ink, cleaning the print heads, or performing another operation.
Plain Paper 360 DPI Ink Jet Paper Photo Quality Ink Jet Paper Photo Quality Glossy Film Ink Jet Transparencies Other/Media Selection Off	The Media Type light indicates which media you selected with the Media Type button. When you print, the printer software checks the software setting and this selection to see if they match. If they do not match, an error message appears on your screen. If you do not want to use this feature or your media is not listed, select Other/Media Selection Off.
All the lights	When all the lights flash, your printer may have an internal error.

Buttons

Operate 	Turns the printer on and off.
LF/FF	Feeds paper line by line. Loads a single sheet or advances continuous or banner paper to the next top-of-form position if held down.
Load/Eject	When paper is not loaded, loads a sheet of paper or a single sheet of continuous paper. When paper is loaded, ejects a sheet of paper. Feeds continuous paper backward to the paper-park position. Ejects banner paper backward. Feeds continuous or banner paper to the tear-off position when pressed after printing and Auto tear-off mode is set to off in default-setting mode.
Pause/Reset	Stops printing temporarily. Resumes printing when pressed again. Clears the printer buffer if pressed for five seconds.
Micro Adjust  Micro Adjust 	Adjusts the loading position or tear-off position for continuous paper. Press the Micro Adjust  button to feed paper forward or press Micro Adjust  to feed paper backward. Micro Adjust settings are saved in the printer's memory.
Cleaning 	Starts the black print head cleaning cycle if pressed for three seconds. See "Cleaning the Print Heads" on page 10.
Cleaning 	Starts the color print head cleaning cycle if pressed for three seconds. See "Cleaning the Print Heads" on page 10.
Media Type	Determines whether the Media Type setting you selected in the printer driver matches the type of media loaded in the printer. If paper is loaded and the Media Type lights flash, the paper-release lever is not in the correct position. Match the paper-release lever position with the media type and paper source you are using.

Note:
The Media Type setting only works when printing from the paper tray with Windows 95 or Macintosh.

Testing the Printer

You can run a printer self test to determine whether the problem lies with the printer itself or some other source.

- ❑ If the test results are satisfactory, the problem lies in your computer or its printer port, software settings, or the interface cable.
- ❑ If the test pages don't print correctly, you may have a problem with your printer.

Follow these steps to test the printer:

1. Load several sheets of paper in the paper tray.
2. Turn off the printer.



Caution:
Use paper that's at least 8.3 inches (210 mm) wide. Otherwise the print head will spray ink directly onto the platen.

3. Hold down the LF/FF button and press the  Operate button to turn on the printer. Then release both buttons. This prints the test pages at 360 dpi. (If the test pages don't print, turn off the printer. Repeat the button sequence, but hold down both buttons for several seconds before releasing them.)

The first page prints on the first and last lines to measure the page length. The next page contains a nozzle check pattern and multicolored character samples.

To print test pages at 180 dpi, hold down the Load/Eject button while turning on the printer instead of LF/FF. The 180-dpi self test prints in black.



Caution:
Never turn off the printer while it is printing. To end the test, always press the Pause button, eject any loaded paper, then turn off the printer.

4. After the second page prints, press the Pause button to stop printing.
5. If the printer loaded any additional paper, press Load/Eject to eject it. Then turn off the printer to end the test.

Default Control Panel Settings

You can change the following "default" settings from the printer's control panel:

Setting	Options
Print direction	Auto , Bi-D, Uni-D
Font	Courier , Roman, Sans Serif, Prestige, Script, Roman T, Sans Serif H, Draft
Pitch	10 , 12, 15, 17.1, or 20 cpi, or Proportional
I/F (interface) mode	Auto , Parallel, Serial, Option
Auto I/F (interface) wait time	10 or 30 seconds
Software (emulation mode)	ESC/P 2 , IBM XL24E
Auto CR (IBM XL24E mode only)	Off , On
AGM (IBM XL24E mode only)	Off , On
Character table	PC437
International character set for Italic table	Italic USA
Auto line feed	Off , On
Network I/F (interface) mode	Off , On
0 slash	0 , Ø
Page length for continuous paper	11 , 12, 8.5, or 70/6 inches or Other
Skip over perforation	Off , On
Auto tear off	Off , On
Banner mode	Off , On
Parallel I/F (interface) transfer rate	Fast , Normal

Changing control panel settings



Note:









The printer's control panel buttons perform different functions while the printer is in default-setting mode. Be sure to carefully follow the instructions your printer prints and don't try to perform standard control panel functions until you've exited default-setting mode.

Follow these steps to change the settings listed above:

1. Load four or more sheets of paper, at least 8.3 inches (210 mm) wide, into the paper tray, making sure the edge guides are positioned correctly and the paper-release lever is set to the singular sheet position.
2. Turn off the printer.
3. While holding down the Media Type button, turn on the printer to enter default-setting mode. Hold down both buttons for three seconds, then release them.

The printer loads a sheet of paper and prints an instruction sheet telling you how to select a language (the default setting is English).

- If you want to print the default-setting instructions in another language, press the Micro Adjust  button until the Ink Out  Yellow and Ink Out  Magenta lights on your control panel indicate the language you want to use.

English	Both lights off
French	Ink Out  Yellow on and Ink Out  Magenta off
German	Ink Out  Yellow flashing and Ink Out  Magenta off
Italian	Ink Out  Yellow off and Ink Out  Magenta on
Spanish	Both lights on
Portuguese	Ink Out  Yellow flashing and Ink Out  Magenta on

- Press the Pause button. The printer prints instructions on changing the default settings.
- Follow the instructions on the sheets to change the necessary settings. Your changes remain in effect until you change them again. (To exit without changing any settings, press the Pause button.)
- When you're finished changing settings, press Load/Eject if you need to eject any loaded paper. Then turn off the printer to exit default-setting mode.
- Wait five seconds, then turn on your printer to resume printing normally.

Installing an Ink Cartridge for the First Time

- Press the  Operate button to turn on the printer. The Operate light and all four Ink Out lights come on and the Pause light begins flashing.
- Open the ink cartridge compartment by pressing the top of the ink compartment door. You see four slots for the ink cartridges.

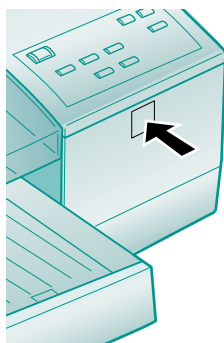

- Open the ink cartridge packages.
- Insert the cartridges, foil plug first, arrow on top, into the slots. Insert cartridges in the following order: yellow, magenta, cyan, and black. Each cartridge is "keyed" so it can be inserted into the correct slot. Push each cartridge all the way into its slot until it meets resistance and the corresponding ink cartridge light turns off.

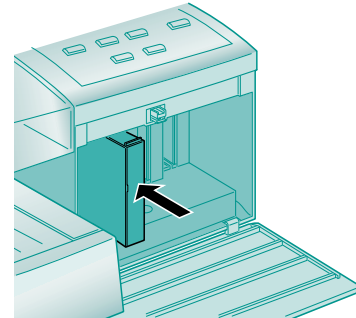

Warning:
If ink gets on your hands, wash them thoroughly with soap and water. If ink gets into your eyes, flush them immediately with water.

- Close the ink compartment door. The printer begins charging the advanced ink delivery system.

Charging takes up to 10 minutes, with the Pause light flashing until it's finished then the Pause light stays on. Do not turn off the printer or interrupt this important process or you'll use up more ink than necessary.



Caution:
Never turn off the printer when the Pause light is flashing. However, if the Pause light is still flashing after 15 minutes and the printer is not moving or making noise, you may turn off the printer.

- When the Pause light stops flashing, the ink charging process is finished. Press the Pause button to turn off the Pause light.

Removing and Installing an Ink Cartridge

When an Ink Out  light flashes, the indicated cartridge is low on ink. This is a good time to make sure you have a new cartridge. When the light stays on, the cartridge is empty and you need to replace it.

If a color ink cartridge runs out of ink, you can continue printing in black ink. See the following section for instructions.



Caution:

For best results, don't replace an ink cartridge unless its Ink Out light is flashing or on.

If you remove an ink cartridge and reinstall it, the printer cannot correctly determine the level of ink and the Ink Out light may not come on when the cartridge runs out of ink.

To ensure good results, use genuine EPSON cartridges and do not refill them. Other products may cause damage to your printer not covered by EPSON's warranty.

You should replace an ink cartridge only when its Ink Out  light is flashing or on.

1. Make sure the printer is turned on and not printing.



Caution:

Leave the empty cartridge installed in the printer until you are ready to replace it.

Once you remove an ink cartridge, it becomes unusable and cannot be reinstalled.

2. Open the ink cartridge compartment by pushing the top of the ink compartment door. You see four slots for the ink cartridges.



Warning:

If ink gets on your hands, wash them thoroughly with soap and water. If ink gets into your eyes, flush them immediately with water.

3. Carefully pull the used ink cartridge straight out of the printer.
4. Make sure the replacement ink cartridge is the correct color; then remove it from its packaging.
5. Insert the ink cartridge into the slot foil with the plug end first and the arrow pointing toward the printer. Push the cartridge all the way into its slot until it meets resistance.

The Ink Out  light turns off. If it remains on, pull the ink cartridge partly out of its slot and reinsert it.

Printing in Black Ink With an Empty Color Cartridge

If a color ink cartridge runs out of ink and its Ink Out  light comes on, you can still continue printing with black ink. (If the black ink cartridge runs out of ink, you cannot continue printing.) However, you will need to resend any print job you were printing when the color ink ran out. Follow these steps:

1. Turn off the printer.
2. Wait five seconds and then turn the printer back on again. Don't remove the empty color ink cartridge.

Caution:

If you're printing on continuous label paper, don't press Load/Eject; this feeds the paper backward and may cause labels to tear off inside the printer.

3. If there is paper in the paper path, press the Load/Eject button to eject it or to advance continuous paper to the tear-off edge. Tear off any continuous sheets and press Load/Eject again to park the continuous paper out of the path.
4. Access the printer software in your application as described in the *User's Guide*. Change the Ink setting for your document to Black and change any other settings as necessary. Then print the document.

To switch back to color printing, follow the steps in "Removing and Installing an Ink Cartridge" to replace the color ink cartridge. Then turn the printer off and on again to reset color printing mode. Be sure to set the Ink setting to Color in your printer software as described in the *User's Guide*.

Using Special Media

Whether you print on plain paper or special media, you need to load it according to the guidelines in the table below. You must also be sure to select the correct Media Type setting in your printer software and on the printer's control panel (Windows 95 and Macintosh only) to match the media you loaded.

The following table lists the available EPSON media, the maximum number of sheets to load, and the Media Type setting to choose.

For complete paper loading instructions for all the printer's paper feeders, see the *User's Guide*.

Note:

If the corresponding Media Type option for your paper is not shown in the Media Type list, change the Print Quality setting in the More Settings dialog box, select Automatic as the Mode setting, or change the predefined setting in the Custom Settings list on the Main menu.

When you load media with this name . . .	Load a maximum of this many sheets in the paper tray . . .	Then select this Media Type setting in your printer software . . .
Plain paper (single sheets)	100 letter size 30 Super A3/B size 30 A2 size	Plain paper
Plain paper (continuous paper)	(See Chapter 3 of the <i>User's Guide</i> for loading instructions.)	
Envelopes	10	
Labels (single sheets)	(See Chapter 3 of the <i>User's Guide</i> for loading instructions.)	
Continuous label paper		
EPSON 360 dpi Ink Jet Paper	70 letter size 30 legal size 30 Super A3/B size 30 A2 size	360 dpi Ink Jet Paper
EPSON Special Coated Paper for 360 dpi Printing		
EPSON High Quality Ink Jet Paper	70 letter size 30 legal size 30 Super A3/B 30 A2 size	Photo Quality Ink Jet Paper
EPSON Photo Quality Ink Jet Paper		
EPSON Special Coated Paper for 720 dpi Printing		
EPSON Photo Quality Ink Jet Cards		
EPSON 720 dpi Index Cards		
EPSON Photo Quality Self Adhesive Sheets	(See Chapter 3 of the <i>User's Guide</i> for loading instructions.)	
EPSON Photo Quality Banner Paper		
EPSON Photo Quality Glossy Paper (use with support sheet)	20 letter size	Photo Quality Glossy Paper
EPSON Photo Quality Glossy Film (use with support sheet)	30 letter size 1 A2 size	Photo Quality Glossy Film
EPSON High Quality Glossy Paper (use with support sheet)	30 letter size 1 A2 size	
EPSON Iron-On Transfer Paper ²	1 sheet	
EPSON Ink Jet Transparencies (use with support sheet)	30 letter size	
EPSON Ink Jet Back Light Film	1 sheet	Ink Jet Back Light Film
EPSON Ink Jet Canvas Cloth	(See Chapter 3 of the <i>User's Guide</i> for loading instructions.)	Ink Jet Canvas Cloth

¹ Load with the short edge leading into the feeder.
² Turn on the Flip Horizontal option to reverse your image before you print it—especially if it includes text—so the image will appear correctly when it's transferred.

Setting the Thickness Lever

Be sure to check the thickness lever position if you print on thick paper such as envelopes or index cards, or if ink smears on your documents. If ink smears on your documents, set the thickness lever to the + position regardless of the paper type. To change the thickness lever position, open the printer cover and change the setting as shown below.

Paper type	Lever position
Standard paper (single sheet)	0
Envelopes	+
Index cards	+
Transparencies	0
Labels	0
Continuous paper	0
Banner paper	0

Cleaning the Print Heads

If your printed image is unexpectedly light or faint, or dots are missing from the image, you may need to clean the print heads. This unclogs the nozzles so they can deliver ink properly.

Note:
 You must print a few lines (for example, a nozzle check) after each print head cleaning in order to reset the cleaning cycle.

Cleaning the print heads uses ink, so clean them only if print quality declines. There are two ways to clean the print heads:

- The Head Cleaning utility in your printer software
- The printer's control panel buttons.

Use either method when the printer is connected directly to the computer. Use the control panel when you are using DOS or the printer is connected via an optional interface card.

Note:
 If any Ink Out lights are flashing or on, you need to replace the ink cartridge instead.

If you were printing when you started cleaning the print heads, the Pause light may still be on. Press the Pause button to turn off the light and resume printing.

Using the Head Cleaning Utility

Follow these steps to run the utility from a Windows computer or a Macintosh:

1. Make sure the printer is turned on but not printing.
2. Make sure all the Ink Out  lights are off.
3. Access the Main printer settings dialog box.

4. Click the Utility tab (Windows) or the Utility button (Macintosh). You see the Utility menu.
5. Click the Head Cleaning icon.
6. Follow the instructions on the screen to clean the print heads. You can clean the black or color print head separately, or you can clean both. Cleaning each head takes up to three minutes, during which the printer makes some noise and the Operate and Pause lights flash.



Caution:
Never turn off the printer while the Pause light is flashing.



If, however, the Pause light flashes for more than five minutes after the printer has stopped moving or making any noise, you may turn off the printer.

When the lights stop flashing, you need to run a nozzle check to test the print quality and reset the cleaning cycle.

7. Make sure paper is loaded in the printer and click Print nozzle check pattern (Windows) or Confirmation (Macintosh), and then click Next.

If your print quality has not improved, repeat the steps above.

Using the Control Panel

1. Make sure the printer is turned on and not printing.
2. Make sure all the Ink Out  lights are off.
3. To clean the black print head, press the  Cleaning button for three seconds.

To clean the color print head, press the  Cleaning button for three seconds.

Cleaning each head takes up to three minutes, during which the printer makes some noise and the Operate and Pause lights flash.

4. After the cleaning cycle is complete and the Pause light stays on without flashing, you can repeat step 3 to clean the other print head, if you wish. Then you need to run a nozzle check to test the print quality and reset the cleaning cycle.
5. Access the Main printer settings dialog box.
6. Click the Utility tab (Windows) or the Utility button (Macintosh). You see the Utility menu.
7. Click the Nozzle Check icon, then click Next. See the next section for instructions on examining the nozzle check pattern.

If your print quality has not improved, repeat the steps above.

Examining the Nozzle Check Pattern

Examine the nozzle check pattern you print. It should look something like this, with the lower pattern colored cyan, magenta, and yellow:



W01372 C01267

Each staggered horizontal and straight vertical line should be complete, with no gaps in the dot pattern. If your printout looks okay, you're done. If any dots are missing, clean the print heads again, as explained in the previous sections.

Aligning the Print Heads

If your printouts contain misaligned vertical lines, you may need to align the print heads.

Using the Print Head Alignment Utility

If you're using Windows or a Macintosh, follow these steps:

1. Make sure the printer is turned on.
2. Load several sheets of paper, at least 8.3 inches (210 mm) wide, into the paper tray, making sure the edge guides are positioned correctly and the paper-release lever is set to the singular sheet position.
3. Access the Main printer settings dialog box.
4. Click the Utility tab (Windows) or the Utility button (Macintosh). You see the Utility menu.
5. Click the Print Head Alignment icon.
6. Follow the instructions on the screen to print an alignment test page and select the correct alignment.

Using the DOS Utility

Before you can align the print heads, you need to install the DOS alignment utility. Follow these steps:

1. Make sure your computer and printer are turned on.
2. Load several sheets of paper, at least 8.3 inches (210 mm) wide, into the paper tray, making sure the edge guides are positioned correctly and the paper-release lever is set to the singular sheet position.
3. Insert the EPSON printer software CD-ROM or diskette into a drive.
4. At the DOS prompt, type D:\SETUP (where D is the drive letter of your drive) and press Enter.

5. You see an installation instruction screen. Follow the instructions on the screen to install the utility on your computer's hard disk drive.
6. Once the utility is installed, log onto the directory you specified for the utility. Then type EPCALIB and press Enter to start the program.

Note:



You can use a mouse with the utility if you have a DOS mouse driver installed.









7. You see the EPSON Print Head Alignment Utility main screen. Make sure your printer is listed on the screen and select Next.
8. Follow the instructions on the utility screens to align your print heads.

Using the Control Panel

1. Load several sheets of paper, at least 8.3 inches (210 mm) wide, into the paper tray, making sure the edge guides are positioned correctly and the paper-release lever is set to the singular sheet position.
2. Turn off your printer.
3. Hold down the Pause button and turn on the printer to turn on print head alignment mode. Be sure to hold down both buttons for three seconds before releasing them.

The printer loads a sheet of paper and prints an instruction sheet telling you how to select a language (the default setting is English).

4. If you want to print the instructions in another language, press the Micro Adjust  button until the Ink Out  Yellow and Ink Out  Magenta lights on your control panel indicate the language you want to use.

English	Both lights off
French	Ink Out  Yellow on and Ink Out  Magenta off
German	Ink Out  Yellow flashing and Ink Out  Magenta off
Italian	Ink Out  Yellow off and Ink Out  Magenta on
Spanish	Both lights on
Portuguese	Ink Out  Yellow flashing and Ink Out  Magenta on

5. Press the Pause button. The printer prints instructions on aligning the print heads using the control panel.
6. Follow the instructions on the sheet. When the print heads are aligned, turn off the printer to exit print head alignment mode.
7. After five seconds, turn on the printer to resume printing.

Transporting the Printer



Caution:

If you don't follow the procedures in this section, ink will leak when you transport the printer.

However, if you are moving your printer a short distance, for example, from one table to another, you don't need to remove the ink cartridges. Be sure to keep the printer level when you move it.

If you want to ship your printer, you need to prepare it for transportation and repack it in the original box. Follow these steps:

1. Turn on the printer.
2. Remove all four of the ink cartridges and store them in separate plastic bags.
3. Close the ink compartment door.
4. Turn off the printer and make sure the print heads are in the home (far right) position. If they are not, turn the printer back on, wait until they stop moving and are in the home position, then turn off the printer.
5. Wait until the printer stops making noise and all the lights stop flashing, then unplug the power cord from the electrical outlet and disconnect the interface cable from the printer.
6. Remove the paper from all the feeders.
7. Remove the edge guides and banner paper cover.
8. Remove the paper tray and paper tray cover.
9. Repack the printer and attachments in the original box using the protective materials that came with it. See the Notice Sheet that was packed with the printer.

Be sure to keep the printer level in an upright position as you transport it.

If you reinstall the cartridges that were removed in step 2, the ink sensor will not correctly indicate the amount of ink in the cartridges. You may run out of ink before the Ink Out lights comes on. If you want the ink sensor to work properly, you need to install new ink cartridges. See page 9 for instructions.

Related Documentation

TM-STYCLR3000	EPSON Stylus COLOR 3000 Service Manual
PL-STYCLR3000	EPSON Stylus COLOR 3000 Parts Price List
4007168	EPSON Stylus COLOR 3000 User's Guide
4007164	EPSON Stylus COLOR 3000 Quick Setup booklet