

Media name	Size	Part number
EPSON Photo Paper	Letter	S041141
	A4	S041140
	4 × 6 inches	S041134
	Panoramic (8.3 × 23.4 inches)	S041145
EPSON Ink Jet Transparencies	Letter	S041064
EPSON Photo Quality Ink Jet Cards	A6 8 × 10 inches	S041054 S041122
EPSON Photo Stickers Kit (CD-ROM and paper)	A6, 16 frames per sheet	S041144-KIT
EPSON Photo Stickers (refill, paper only)	A6, 16 frames per sheet	S041144
EPSON Iron-On Cool Peel Transfer Paper	Letter	S041153/S041155
EPSON Photo Quality Self Adhesive Sheets	A4	S041106
Matte Paper - Heavyweight	Letter	S041257

## Printer Specifications

### Printing

Printing method On-demand ink jet

Nozzle configuration

Black 144 nozzles  
 Color 144 nozzles  
 (48 each: cyan, magenta, yellow)

Resolution Maximum 1440 dpi × 720 dpi

Print direction Bidirectional with logic seeking

Control code ESC/P Raster,<sup>TM</sup> EPSON Remote

Input buffer 256KB

## Accessories

### Ink Cartridges

Cartridge	Part number
Black	S020189
Color	S020191

### Media

Media name	Size	Part number
EPSON 360 dpi Ink Jet Paper	Letter	S041060
	A4	S041059
EPSON High Quality Ink Jet Paper	Letter A4	S041111 S041117
EPSON Photo Quality Ink Jet Paper	Letter	S041062
	A4	S041061
	Legal	S041067
EPSON Photo Quality Glossy Paper	Letter A4	S041124 S041126
EPSON Photo Quality Glossy Film	Letter	S041072
	A4	S041071
	A6	S041107

## Paper

Paper type	Size	Paper types	Thickness	Weight
Single sheets	Letter (8.5 × 11 inches) Legal (8.5 × 14 inches) Half letter (statement, 5.5 × 8.5 inches) Executive (7.5 × 10 inches) A4 (210 × 297 mm) A5 (148 × 210 mm)	Plain bond paper and special ink jet papers distributed by EPSON	0.003 to 0.004 inch (0.08 to 0.11 mm) for plain bond paper	17 to 24 lb (64 to 90 g/m <sup>2</sup> ) for plain bond paper
Transparencies, glossy film, glossy paper	Letter (8.5 × 11 inches) A4 (210 × 297 mm) A6 (105 × 148 mm), glossy film only	Transparencies, glossy paper, and glossy film distributed by EPSON	—	—
Matte Paper - Heavyweight	Letter (8.5 × 11 inches)	Matte paper distributed by EPSON	—	—
Self-adhesive sheets	A4 (210 × 297 mm)	Self adhesive sheets distributed by EPSON	—	—
Envelopes	No. 10, 4.1 × 9.5 inches (104 × 140 mm) DL, 4.3 × 8.7 inches (110 × 220 mm) C6, 4.4 × 6.4 inches (114 × 162 mm) 132 × 220 mm (5.2 × 8.7 inches)	Plain bond paper or air mail paper	0.006 to 0.02 inch (0.16 to 0.52 mm)	12 to 20 lb (45 to 75 g/m <sup>2</sup> )
Index (ink jet) cards	A6 (105 × 148 mm) 8 × 10 inches (203 × 254 mm)	Ink jet cards distributed by EPSON	—	—
Photo Paper	Letter (8.5 × 11 inches) A4 (210 × 297 mm) 4 × 6 inches (102 × 152 mm) Panoramic (210 × 594 mm)	Photo paper distributed by EPSON	—	—
Photo Stickers	A6 (105 × 148 mm), 16 frames/sheet	Photo stickers distributed by EPSON	—	—
Iron-On Cool Peel Transfer Paper	Letter (8.5 × 11 inches)	Transfer paper distributed by EPSON	—	—

### Note:

Always load paper into the sheet feeder short edge first. Envelopes should be loaded flap edge first, with the flap side down

Since the quality of any particular brand or type of paper may be changed by the manufacturer at any time, EPSON cannot attest to the quality of any non-EPSON brand or type of paper. Always test samples of paper stock before purchasing large quantities or printing large jobs.

Poor quality paper may reduce print quality and cause paper jams and other problems. If you encounter problems, switch to a higher grade of paper.

Do not load curled or folded paper.

Use papers under these conditions:

Temperature: 59 to 77 °F (15 to 25 °C)  
Humidity: 40 to 60% RH

Store printouts on EPSON Photo Quality Glossy Film and Self Adhesive Sheets under these conditions:

Temperature: 59 to 86 °F (15 to 30 °C)  
Humidity: 20 to 60% RH

### Printable area

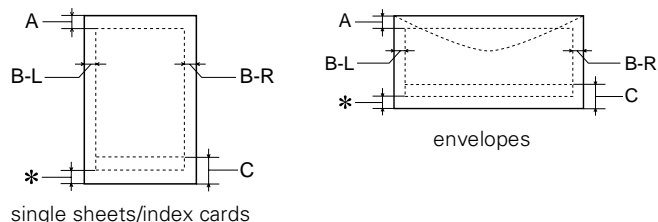

- A: The minimum top margin is 0.12 inch (3.0 mm).  
When loading multiple sheets of EPSON Photo Quality Glossy Film, the minimum top margin is 1.2 inches (30 mm).
- B-L: The minimum left margin is 0.12 inch (3.0 mm).
- B-R: The minimum right margin is as follows:  
0.12 inch (3.0 mm) for single sheets and C6 envelopes  
0.28 inch (7 mm) for DL envelopes.  
1.10 inch (28 mm) for No. 10 envelopes.
- C: The minimum bottom margin is 0.54 inch (14.0 mm).
- \* You can extend the minimum bottom margin to 0.12 inch (3.0 mm) by selecting Maximum as the Printable Area setting. However, print quality may decline in the expanded area. Before printing large jobs, print a single sheet to confirm print quality.

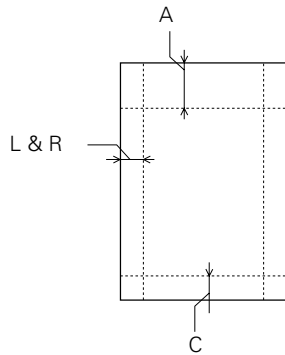

EPSON 4 × 6-inch Photo Paper  
(dotted lines indicate perforations)

- A: The maximum top margin is 0.67 inch (17.0 mm).
- L & R: The maximum left and right margin is 0.24 inch (6.1 mm).
- C: The maximum bottom margin is 0.24 inch (6.1 mm).

### Ink Cartridges

Specification	Black ink cartridge (S020189)	Color ink cartridge (S020191)
Color(s)	Black	Cyan, Magenta, Yellow
Print capacity*	900 pages text (ISO/IEC 10561 letter pattern) 634 pages graphic (5% coverage)	300 pages (15% coverage)
Cartridge life	2 years from production date (if unopened) (within 6 months after opening package, at 77 °F [25 °C])	
Storage temperature	-4 to 104 °F (-20 to 40 °C) 1 month at 104 °F (40 °C)	
Transit temperature	-22 to 140 °F (-30 to 60 °C) 1 month at 104 °F (40 °C) 120 hours at 140 °F (60 °C)	
Freezing temperature**	3.2 °F (-16 °C)	-0.4 °F (-18 °C)
Dimensions	1.09 (W) × 2.1 (D) × 1.5 (H) inches 27.8 (W) × 52.7 (D) × 38.5 (H) mm	1.7 (W) × 2.1 (D) × 1.5 (H) inches 42.9 (W) × 52.7 (D) × 38.5 (H) mm

\* The figure given is based on continuous printing after ink replacement. The actual print capacity may vary, depending on how often you turn on the printer and how often you clean the print head.

\*\* Ink thaws and is usable after approximately 3 hours at 77 °F (25 °C).

**Caution** To ensure good results, use genuine EPSON cartridges and do not refill them. Other products may cause damage to your printer not covered by EPSON's warranties.

Don't use an ink cartridge if the date on the package has expired.

### Mechanical

Paper feed method	Friction
Paper path	Sheet feeder, rear entry
Sheet feeder capacity	100 sheets of 17 lb (64 g/m <sup>2</sup> ) paper
Dimensions	
Storage	Width: 17.7 inches (450 mm) Depth: 10.6 inches (269 mm) Height: 6.9 inches (175 mm)
Printing	Width: 17.7 inches (450 mm) Depth: 24.7 inches (628 mm) Height: 11.9 inches (303 mm)
Weight	13.2 lb (6 kg) without the ink cartridges

### Electrical

Specification	120 V Model	220–240 V Model
Input voltage range*	99 to 132 V	198 to 264 V
Rated frequency range	50 to 60 Hz	
Input frequency range	49.5 to 60.5 Hz	
Rated current	0.4 A	0.2 A
Power consumption	Approx. 18 W (ISO/IEC 10561 Letter Pattern) Approx. 3.5 W in standby mode	

\* Check the label on the back of the printer for your printer's voltage.

### Environmental

Temperature	
Operation	50 to 95 °F (10 to 35 °C)
Storage*	-4 to 104 °F (-20 to 40 °C) 1 month at 104 °F (40 °C)
Transit*	-4 to 140 °F (-20 to 60 °C) 120 hours at 140 °F (60 °C)

Humidity (without condensation)

Operation	20 to 80% RH
Storage*	5 to 85% RH

\*Stored in shipping container







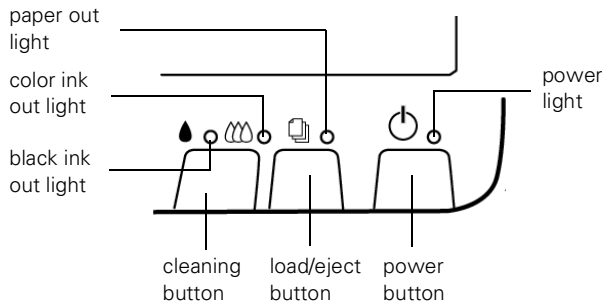















### Safety Approvals









Safety standards	UL 1950, CSA C22.2 No. 950
EMC	FCC part 15 subpart B class B

## Control Panel



Follow these guidelines when you check the control panel lights.

 is on	The  power light is on when the printer is on and ready to print. It flashes when the printer is receiving a print job, charging ink, or cleaning the print head.
 flashes and  and  are on	When the  paper out light flashes and both ink out lights come on, you have a paper jam. Press the  load/eject button to try to clear the jam. If that doesn't work, turn off the printer and gently pull out all the paper. Make sure none of the sheets are curled, creased, old, stuck together, or too thin. Then reload the paper against the right edge guide and slide the left edge guide against it. Turn on the printer and press the  load/eject button to resume printing.
 is on	When the  paper out light comes on, your paper is out or incorrectly loaded. Make sure none of the sheets are curled, creased, old, stuck together, or too thin. Then reload the paper against the right edge guide and slide the left edge guide against it. Press the  load/eject button to resume printing.
 or  flash	When an ink out light flashes, your ink supply is low. Make sure you have a replacement cartridge (black S020189, color S020191).
 or  are on	When an ink out light comes on, you need to replace the ink cartridge. Make sure you have a replacement cartridge (black S020189, color S020191). See page 6 for instructions.
 and  flash and  and  are on	When the  power and  paper out lights flash and the  black and  color ink out lights come on, jammed paper may be blocking movement of the print head or you may not have removed the yellow tape seal from the installed ink cartridge(s). Turn off the printer, open the cover, and check inside for any jammed paper. Then turn the printer back on. If an ink out light remains on and the print head moves into replacement position, replace the ink cartridge(s) as described on page 8. If the lights still flash and/or come on, contact your dealer or EPSON.

    flash	When all the lights flash, your printer may have an internal error. Make sure you removed all the packing material as described on the unpacking sheet in your printer box. Then turn off the printer, wait a few seconds, and turn it on again. If the lights still flash, contact your dealer or EPSON.
    are off	When all the lights are off, the printer is not receiving power. Try these solutions: <ul style="list-style-type: none"> <li><input type="checkbox"/> Make sure the printer is turned on.</li> <li><input type="checkbox"/> Turn off the printer, plug in the power cord securely, and turn on the printer again.</li> <li><input type="checkbox"/> Make sure the outlet is operable and is not controlled by a switch or timer. If in doubt, try using another outlet.</li> </ul>

## Installing an Ink Cartridge for the First Time







Follow these ink cartridge precautions:

- Install both ink cartridges, and leave them installed for all types of printing, or the printer won't work.
- Remove the yellow tape seal from the top of the ink cartridges or you'll permanently damage them. Don't remove the clear seals on the bottom or ink will leak out.
- Don't open an ink cartridge clamp to remove a cartridge except to replace it with a new one. Once you remove a cartridge, you can't reuse it, even if it contains ink.
- Never turn off the printer when the  power light is flashing, unless the printer hasn't moved or made any noise for more than five minutes.



Keep ink cartridges out of the reach of children.

If ink gets on your hands, wash them thoroughly with soap and water. If ink gets in your eyes, flush them immediately with water.

1. Lower the output tray and open the printer cover.
2. Press the  power button to turn on the printer. The  power light flashes and the  black and  color ink out lights come on. The ink cartridge holders move left into loading position.



Don't use an outlet that is controlled by a wall switch or timer, or one on the same circuit as a large appliance, to avoid damaging the printer's power supply.

Always use the  power button to turn the printer on or off. Never use an external switch, such as a power strip switch.

- Lift up the two ink cartridge clamps.

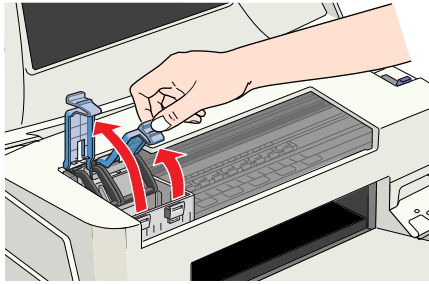

- Unwrap the ink cartridges, then remove only the yellow part of the tape seal on the top. Don't pull off the blue part.

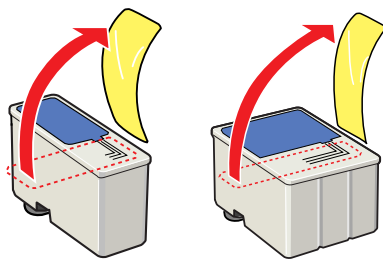

black cartridge

color cartridge

- Insert both ink cartridges with the labels facing up as shown. Press down the clamps until they lock into place, but don't press down on the ink cartridges.

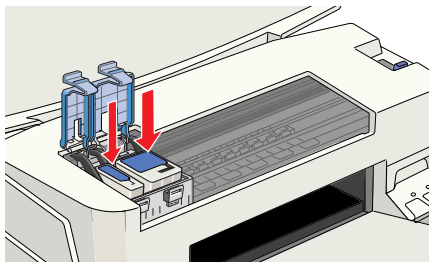





- Press the  cleaning button and close the printer cover.

Ink charging takes about two minutes, with the  power light flashing and the printer making noise until it's finished.

Don't turn off the printer or interrupt charging or it will start over, using more ink than necessary. It's finished when the  power light stops flashing.

## Testing the Printer

You can run a printer check to determine whether a problem comes from the printer itself or some other source. Follow these steps to run the printer check:

- Make sure both the printer and computer are turned off.
- Disconnect the interface cable from the printer.
- Make sure paper is loaded in the printer.
- Hold down the  load/eject button, then press and release the  power button. Continue holding down the  load/eject button until the  power light starts to flash, then release it.

The printer prints one page showing its ROM version number, ink counter, and a nozzle check pattern. Only the nozzle check pattern is shown below. (If the pattern has gaps in its dots, you need to clean the print head; see page 9.)

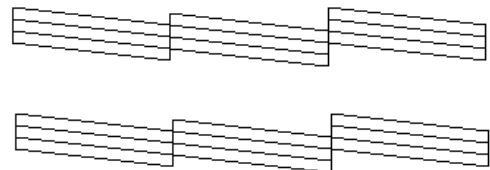

- To end the check, turn off the printer after it prints the check page. Then reconnect the interface cable and turn on your printer and computer.

If the check page prints, the problem probably lies in your software settings, the interface cable, or your computer.

If the check page doesn't print, you may have a problem with your printer.

Try the suggestions in "Problems and Solutions" in the *Printer Basics* book.

## Printing on Special Media

Whether you print on plain paper or special media, you need to select the Media Type setting according to the guidelines in the table below.

For this paper name...	Select this Media Type setting
Plain paper and envelopes	Plain paper
EPSON 360 dpi Ink Jet Paper	360 dpi Ink Jet Paper
EPSON Iron-On Cool Peel Transfer Paper	
EPSON High Quality Ink Jet Paper	Photo Quality Ink Jet Paper
EPSON Photo Quality Ink Jet Paper	
EPSON Photo Quality Ink Jet Cards	
EPSON Photo Quality Self Adhesive Sheets	
EPSON Photo Quality Glossy Paper	Photo Paper
EPSON Photo Paper	
EPSON Photo Quality Glossy Film	Photo Quality Glossy Film
EPSON Photo Stickers	
EPSON Ink Jet Transparencies	
Matte Paper - Heavyweight	Matte Paper - Heavyweight

## Additional Media Loading Guidelines

**Caution** Don't use the cleaning sheets that may be included with your special media; they may damage the printer.

- Be sure to load the printable (whiter) side of the media face up in the sheet feeder.
- You can load paper up to the arrow mark on the left edge guide.
- In addition to the Media Type option, remember to select the correct Paper Size for your media on the Paper menu.
- If the special media has protective sheets between each sheet of media, be sure to remove the protective sheets before printing.

- Some special media have a cut corner that you need to position correctly; follow any instructions in the package. Always handle sheets by the edges, and don't touch the printable surface.

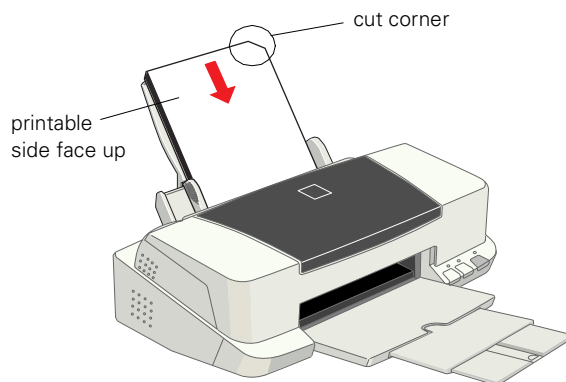

## Replacing an Ink Cartridge

When the black or color ink out light flashes, the indicated cartridge is low on ink. This is a good time to make sure you have a new cartridge. When the light stays on, the cartridge is empty and you need to replace it.

**Caution** You cannot print if either ink cartridge is empty. Leave the empty cartridge installed in the printer until you have obtained a replacement. Otherwise the ink remaining in the print head nozzles may dry out.

Use these EPSON ink cartridges within six months of installing them and before the expiration date on the package:



- Black ink cartridge: S020189
- Color ink cartridge: S020191

**Caution** To ensure good results, use genuine EPSON ink cartridges and do not refill them. Other products may cause damage to your printer not covered by EPSON's warranty.

When you need new ink cartridges, contact your dealer or call EPSON Accessories at (800) 873-7766 or visit our web site at [www.epsonsupplies.com](http://www.epsonsupplies.com) (U.S. sales only). In Canada, please call (800) 873-7766 for dealer referral.



If you need to replace an ink cartridge before the lights flash (because the ink is too old, for example) follow the instructions in "Replacing an Outdated Ink Cartridge" on page 8.

## Removing and Installing Ink Cartridges

You can replace a cartridge when the  black or  color ink out light is either flashing or on. (If you perform these steps when both ink out lights are off, the printer cleans the print heads as described on page 9.)

Be sure you have a new ink cartridge before you begin. Once you start the ink cartridge replacement procedure, you must complete all the steps in one session.

Follow these steps to replace ink cartridges:

1. Make sure the printer is turned on and not printing (the  power light should be on, but not flashing), then open the printer cover.
2. Press the  cleaning button and hold it for about three seconds until the print head moves left and the  power light begins flashing.

 **Caution** To avoid damaging the printer, never move the print head by hand. Don't open the clamp or remove a cartridge except to replace it with a new one. Once you remove a cartridge, you can't reuse it, even if it contains ink.

3. Pull up the ink cartridge clamp. The cartridge rises up from its holder. (The illustration shows color ink cartridge replacement. To replace the black ink cartridge, lift up only the smaller clamp on the left.)

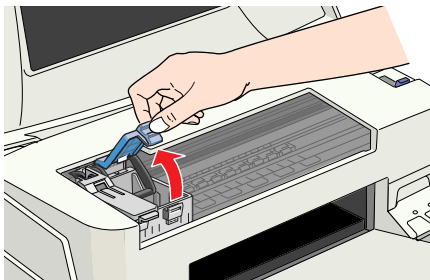

4. Lift the cartridge out of the printer and dispose of it carefully.

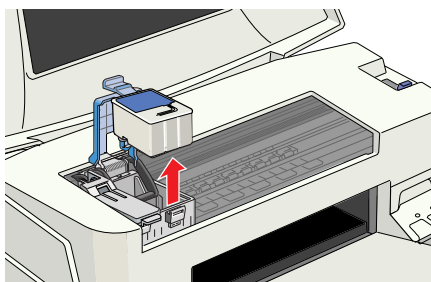

 **Warning** Keep ink cartridges out of the reach of children.

If ink gets on your hands, wash them thoroughly with soap and water. If ink gets into your eyes, flush them immediately with water.

5. Unwrap the new ink cartridge. Then remove *only* the yellow part of the tape seal on top. Don't remove the blue part of the tape seal.

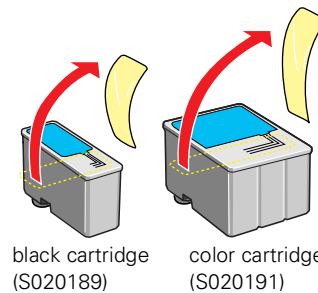



 **Caution** You must remove the yellow tape from the top of the cartridge or you will permanently damage it. Don't pull off the blue portion or try to remove the clear seal underneath the cartridge.

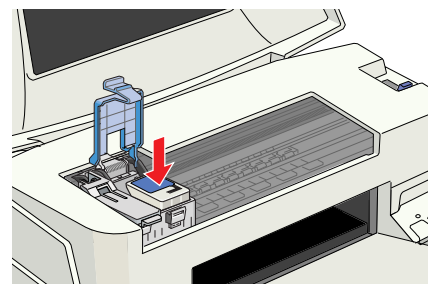

6. Lower the new ink cartridge into its holder with the label facing up and toward the back of the printer.

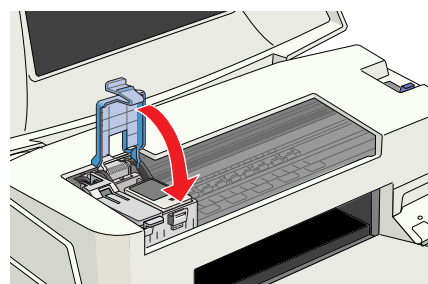

7. Press down the ink cartridge clamp until it locks in place, but don't press down on the cartridge itself.



8. If you need to replace the other ink cartridge, repeat steps 3 through 7 before continuing with step 9.
9. Press the  cleaning button and close the printer cover. The printer moves the print head and begins charging the ink delivery system.

The  power light flashes, and the printer makes noise. Charging takes about 30 seconds. When it's finished, the  power light stops flashing and stays on.

**Caution** Never turn off the printer while the power light is flashing, unless the printer hasn't moved or made noise for more than 5 minutes.

### Replacing an Outdated Ink Cartridge

When an ink cartridge is more than six months old, you may need to replace it if you notice that your printouts don't look as good as they used to. If print quality doesn't improve after cleaning and aligning the print head, you can replace one or both cartridges.

Follow these steps to replace an ink cartridge *before* the black or color ink out light is flashing or on:

1. Make sure the printer is turned on and not printing (the power light should be on, but not flashing), then open the printer cover.
2. Press the load/eject button and hold it for about three seconds until the print head moves left and the power light begins flashing.

**Caution** To avoid damaging the printer, never move the print head by hand. Don't open the clamp or remove a cartridge except to replace it with a new one. Once you remove a cartridge, you can't reuse it, even if it contains ink.

3. Pull up the ink cartridge clamp. The cartridge rises up from its holder. (The illustration shows color ink cartridge replacement. To replace the black ink cartridge, lift up only the smaller clamp on the left.)

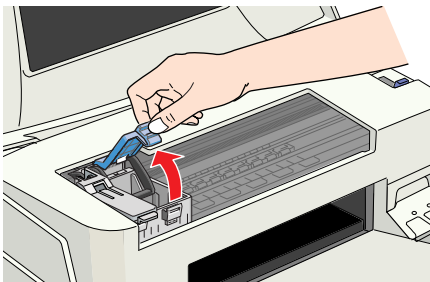

4. Lift the cartridge out of the printer and dispose of it carefully.

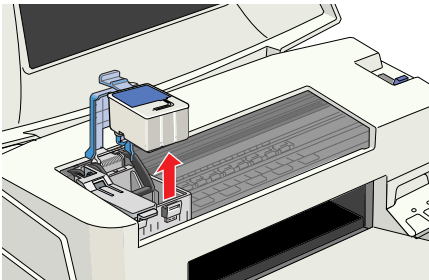

**Warning** Keep ink cartridges out of the reach of children.

If ink gets on your hands, wash them thoroughly with soap and water. If ink gets into your eyes, flush them immediately with water.

5. Unwrap the new ink cartridge. Then remove *only* the yellow part of the tape seal on top. Don't remove the blue part of the tape seal.

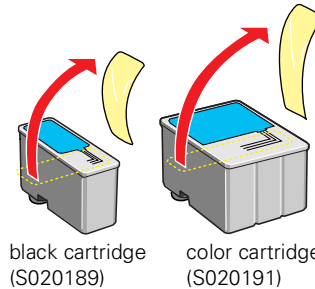

**Caution** You must remove the yellow tape from the top of the cartridge or you will permanently damage it. Don't pull off the blue portion or try to remove the clear seal underneath the cartridge.

6. Lower the new ink cartridge into its holder with the label facing up and toward the back of the printer.

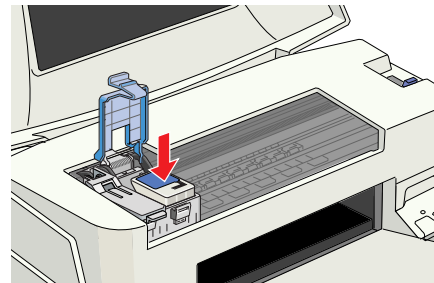

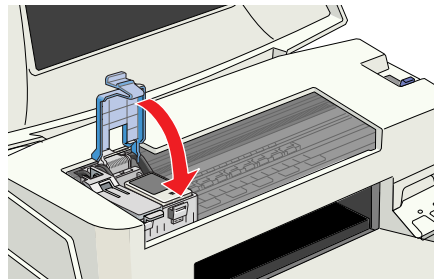

7. Press down the ink cartridge clamp until it locks in place, but don't press down on the cartridge itself.





8. If you need to replace the other ink cartridge, repeat steps 3 through 7 before continuing with step 9.



- Press the  load/eject button again and close the printer cover. The printer moves the print head and begins charging the ink delivery system.

The  power light flashes and the printer makes noise. Charging takes about 30 seconds. When it's finished, the  power light stops flashing and stays on.

 Never turn off the printer while the  power light is flashing, unless the printer hasn't moved or made noise for more than 5 minutes.

## Cleaning the Print Head

If your printed image is unexpectedly light or faint, or dots are missing from the image, you may need to clean the print head. This unclogs the nozzles so they can deliver ink properly.

Cleaning the print head uses ink, so clean it only if print quality declines. You can clean the print head in either of the following ways:



- using the Head Cleaning utility (when the printer is connected to a local port, not over a network), as described on page 9
- using the printer's control panel buttons, as described on page 9

 When you don't turn on your printer for a long time, the print quality can decline. It's a good idea to turn on your printer at least once a month to maintain good print quality.



If any paper you buy comes with a cleaning sheet, don't use the cleaning sheet with your printer; it may jam inside the printer.

## Using the Head Cleaning Utility

Follow these steps to run the Head Cleaning utility:

- Make sure the printer is turned on but not printing, and both the  black and  color ink out lights are off. (If an ink out light is flashing, replace the ink cartridge before continuing.)
- If you have an application running, access the printer settings dialog box.  
  
Or, with Windows, click **Start**, point to **Settings**, then select **Printers**. Right-click your **EPSON Stylus COLOR 860** printer icon in the **Printers** windows. Then select **Properties (Document Defaults in Windows NT)**.
- Windows:** Click the **Utility** tab.  
**Macintosh:** Click the  Utility button.
- On the Utility menu, click the **Head Cleaning** button.

- Follow the instructions on the screen to clean the print head. Cleaning takes about 30 seconds, during which the printer makes some noise and the  power light flashes.

 Never turn off the printer while the  power light is flashing, unless the printer hasn't moved or made noise for more than 5 minutes.

- When the  power light stops flashing, run a nozzle check to confirm the print head nozzles are clean and reset the cleaning cycle.





Make sure paper is loaded in the printer and click **Print nozzle check pattern**. Then click **Next**. The nozzle check pattern prints (see page 10 for details).



- If the nozzle check pattern has no gaps in its dots, click **Finish**.

If the pattern is missing dots, click **Clean** to clean the print head again. If you don't see any improvement after cleaning three or four times, check the solutions in the *Printer Basics* book. You can also turn the printer off and wait overnight—this allows any dried ink to soften—and then try cleaning the print head again.

## Using the Control Panel to Clean the Print Head

Follow these steps to clean the print head:

- Make sure the printer is turned on but not printing, and both the  black and  color ink out lights are off. (If an ink out light is flashing, replace the ink cartridge before continuing.)
- Press the  cleaning button and hold it down for three seconds. Cleaning takes about 30 seconds, during which the printer makes some noise and the  power light flashes.

 Never turn off the printer while the  power light is flashing, unless the printer hasn't moved or made noise for more than 5 minutes.

- After the  power light stops flashing, print a page to test the print quality and reset the cleaning cycle.

If your printer is connected directly to the computer, go to step 4 to run a nozzle check.

If you're printing over a network, open an application and print a short document containing black and color data. Then go to step 8.

- If you have an application running, access the printer settings dialog box.

Or, with Windows, click **Start**, point to **Settings**, then select **Printers**. Right-click your **EPSON Stylus COLOR 860** printer icon in the **Printers** windows. Then select **Properties (Document Defaults in Windows NT)**.

5. **Windows:** Click the **Utility** tab.

**Macintosh:** Click the  Utility button.

6. Make sure paper is loaded in the printer, click the **Nozzle Check** button, and click **Next**. The nozzle check pattern prints (see the next section for details).

7. If the nozzle check pattern has no gaps in its dots, click **Finish**.

If the pattern is missing dots, click **Clean** to clean the print head again.

8. If you don't see any improvement after cleaning three or four times, check the solutions in the *Printer Basics* book. You can also turn the printer off and wait overnight—this allows any dried ink to soften—and then try cleaning the print head again.

## Examining the Nozzle Check Pattern

Examine the nozzle check pattern you print. It should look something like this:

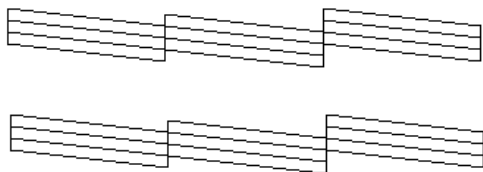

Each staggered horizontal and straight vertical line should be complete, with no gaps in the dot pattern. If your printout looks okay, you're done. If any dots are missing, as shown below, clean the print head again; see page 9 for instructions.

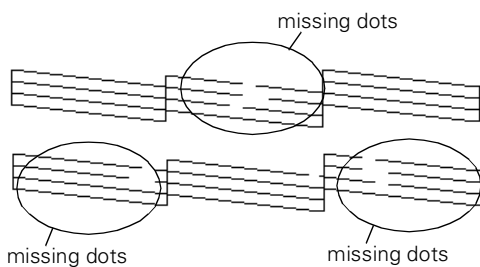

## Aligning the Print Head

If your printouts contain misaligned vertical lines, you may need to align the print head. Your printer must be connected to a local port, not on a network, to use the Print Head Alignment utility.

Follow these steps:

1. Make sure the printer is turned on, but not printing, and letter-size paper is loaded.



Load paper that's at least 8.27 inches (210 mm) wide to prevent ink from spraying inside the printer and smudging your printouts.

For the best results, load EPSON ink jet paper in the printer whenever you check the print head alignment.

2. If you have an application running, access the printer settings dialog box.

Or, with Windows, click **Start**, point to **Settings**, then select **Printers**. Right-click the **EPSON Stylus COLOR 860** icon in the Printers windows. Select **Properties (Document Defaults in Windows NT)**.

3. **Windows:** Click the **Utility** tab.

**Macintosh:** Click the  Utility button.

4. You see the Utility menu. Click the **Print Head Alignment** button.

5. Follow the instructions on the screen to print a test page.

6. Select the most precise alignment pattern from the choices on the test page. Enter the number of the best aligned pattern following the instructions on the screen.

## Cleaning the Printer

To keep your printer working at its best, you should clean it several times a year. Follow these steps:

1. Turn off the printer, unplug the power cord, and disconnect the printer cable.
2. Remove all the paper from the sheet feeder.
3. Clean the exterior of the printer with a soft, damp cloth.
4. Clean ink out of the printer's interior with a soft, damp cloth.



Don't touch the gears inside the printer.

Never use alcohol or thinner for cleaning; they can damage the printer components and case.

Don't use a hard or abrasive brush.

Don't get water on the printer components and don't spray lubricants or oils inside the printer.

Don't use any cleaning sheets included with special media; they may jam inside the printer.

## Transporting the Printer

If you move your printer some distance, you need to prepare it for transportation in its original box. Follow these steps:



To avoid damage, always leave the ink cartridges installed when transporting the printer.

Be sure to remove the tape used in step 4 after installing the printer in its new location.

1. Turn on the printer, wait until the print head locks in the far right position, then turn off the printer.
2. Unplug the power cord from the electrical outlet. Then disconnect the printer cable from the printer.
3. Remove any paper from the printer and remove the paper support.
4. Open the printer cover. Secure the ink cartridge holder to the printer with tape as shown, then close the printer cover.

Tape the ink cartridge holder to the printer case

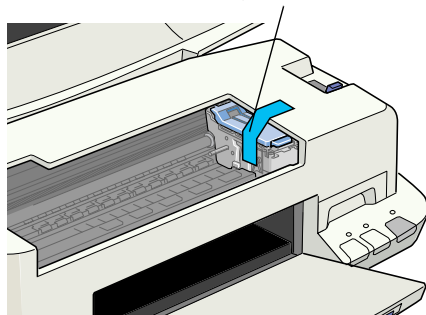

5. Push in the output tray extensions and close the tray.
6. Repack the printer and attachments in the original box using the protective materials that came with it. See the unpacking sheet that was packed with your printer.

Be sure to keep the printer level as you transport it.

After transporting the printer, remove the tape securing the print head and test your printer. If you notice a decline in print quality, clean the print head (see page 9); if output is misaligned, align the print head (see page 10).

## Related Documentation

TM-SC860/1160	EPSON Stylus COLOR 860/ EPSON Stylus COLOR 1160 Service Manual
PL-SC860	EPSON Stylus COLOR 860 Parts Price List
CPD 8991	EPSON Stylus COLOR 760/ EPSON Stylus COLOR 860 <i>Printer Basics</i>
CPD 8992	EPSON Stylus COLOR 760/ EPSON Stylus COLOR 860 <i>Start Here</i>
CPD 9224	EPSON Stylus COLOR 760/ EPSON Stylus COLOR 860 <i>Unpacking the Printer</i>