

Media

Paper name	Size	Part number
EPSON 360 dpi Ink Jet Paper	Letter	S041060
	A4 (8.3 x 11.7 inches)	S041059
EPSON High Quality Ink Jet Paper	Letter	S041111
	A4 (8.3 x 11.7 inches)	S041117
EPSON Photo Quality Ink Jet Paper	Letter	S041062
	A4 (8.3 x 11.7 inches)	S041061
	Legal	S041067
EPSON Photo Quality Ink Jet Cards	A6 (4.1 x 5.8 inches)	S041054
	8 x 10 inches	S041122
EPSON Photo Paper	4 x 6 inches	S041134
	Letter	S041141
	A4 (8.3 x 11.7 inches)	S041140
	Panoramic (8.3 x 23 inches)	S041145
EPSON Photo Stickers Kit (CD-ROM/paper) EPSON Photo Stickers (refill)	A6 (4.1 x 5.8 inches)	S041144-KIT
	A6 (4.1 x 5.8 inches)	S041144
EPSON Photo Quality Glossy Film	Letter	S041072
	A4 (8.3 x 11.7 inches)	S041071
	A6 (4.1 x 5.8 inches)	S041107
EPSON Ink Jet Transparencies	Letter	S041064
	A4 (8.3 x 11.7 inches)	S041063
EPSON Photo Quality Self Adhesive Sheets	A4 (8.3 x 11.7 inches)	S041106
EPSON Iron-On Cool Peel Transfer Paper	Letter	S041153/ S041155

Accessories

User Replaceable Parts

Part name	Part number
Paper support assembly	1040662
Printer cover assembly	1042793
Logo plate	1044907

Ink Cartridges

Cartridge	Part number
Black	T003011
Color	T005011

Printer Specifications

Printing

Printing method	On-demand ink jet				
Nozzle configuration	<table> <tr> <td>black</td> <td>192 nozzles</td> </tr> <tr> <td>color</td> <td>288 nozzles (96 each cyan, magenta, yellow)</td> </tr> </table>	black	192 nozzles	color	288 nozzles (96 each cyan, magenta, yellow)
black	192 nozzles				
color	288 nozzles (96 each cyan, magenta, yellow)				
Resolution	Maximum 1440 x 720 dpi				
Input buffer	256KB				
Print direction	Bidirectional with logic seeking				
Control code	ESC/P 2™ and raster graphics code, EPSON Remote, and IBM® X24E emulation code				
Character tables	1 italic and 12 graphics character tables				
Character sets	14 international character sets and 1 legal character set				

Paper

Paper type	Size	Paper types	Thickness	Weight
Single sheets	Letter (8.5 × 11 inches) A4 (210 × 297 mm) A5 (148 × 210 mm) B5 (182 × 257 mm) Legal (8.5 × 14 inches) Half letter (5.5 × 8.5 inches) Executive (7.5 × 10 inches)	Plain paper and special ink jet papers distributed by EPSON	0.003 to 0.004 inch (0.08 to 0.11 mm)	17 to 24 lb (64 to 90 g/m ²)
Transparencies and glossy film	Letter (8.5 × 11 inches) A4 (210 × 297 mm) A6 (105 × 148 mm, glossy film only)	Transparencies and glossy film distributed by EPSON	—	—
Photo Paper	4 × 6 inches (102 × 152 mm) Letter (8.5 × 11 inches) A4 (210 × 297 mm) Panoramic (8.27 × 23.4 inches, 210 × 584 mm)	Photo Paper distributed by EPSON	—	—
Photo stickers	A6 (105 × 148 mm) with 16 frames	Photo stickers distributed by EPSON	—	—
Self adhesive sheets and iron-on cool peel transfer paper	A4 (210 × 297 mm) Letter (8.5 × 11 inches; iron-on cool peel transfer paper only)	Self adhesive sheets and iron-on cool peel transfer paper distributed by EPSON	—	—
Envelopes	#109.5 × 4.1 inches (240 × 104 mm) DL 8.7 × 4.3 inches (220 × 110 mm) C6 4.4 × 6.4 inches (114 × 162 mm) Note card envelope 5.2 × 8.7 inches (132 × 220 mm)	Plain, bond, or air mail paper	0.006 to 0.02 inch (0.16 to 0.52 mm)	12 to 20 lb (45 to 75 g/m ²)
Cards	A6 (105 × 148 mm) 8 × 10 inches (203 × 254 mm; ink jet cards only)	Ink jet cards and note cards distributed by EPSON	—	—

Note:

Print only under these conditions:

Temperature: 59 to 77 °F (15 to 25 °C)

Humidity: 40 to 60% RH

Store glossy film and self adhesive sheets under these conditions:

Temperature: 59 to 86 °F (15 to 30 °C)

Humidity: 20 to 60% RH

Since the quality of any particular brand or type of paper may be changed by the manufacturer at any time, EPSON cannot guarantee the use of any particular brand or type of paper. Always test samples of paper stock before purchasing large quantities or printing large jobs.

Poor quality paper may reduce print quality and cause paper jams and other problems. If you encounter problems, switch to a higher grade of paper. Do not load curled or folded paper, envelopes, or transparencies.

Printable Area

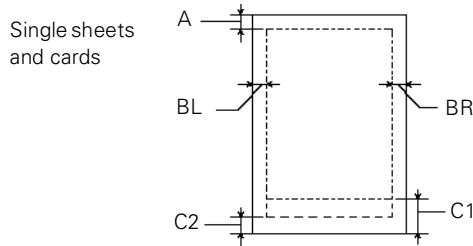

Envelopes

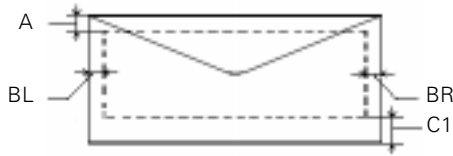

- A The minimum top margin is 0.12 inch (3.0 mm).
When printing multiple sheets of EPSON Photo Quality Glossy Film, the minimum top margin is 1.2 inches (30 mm).
- BL The minimum left margin is 0.12 inch (3.0 mm).
- BR The minimum right margin is:
0.35 inch (9.0 mm) for letter and legal
1.10 inches (28 mm) for #10 envelopes
0.28 inch (7 mm) for DL envelopes
0.12 inch (3.0 mm) for all other paper sizes and C6 envelopes.
- C1 The minimum bottom margin is 0.55 inch (14.0 mm) using the Standard printable area setting.
- C2 The minimum bottom margin can be decreased to 0.12 inch (3.0 mm) using the Maximum printable area setting. However, the print quality in the expanded printable area may be reduced.

Note:
Always load paper into the sheet feeder short edge first except envelopes. Load envelopes long edge first.

Ink Cartridges

Specification	Black ink cartridge (T003011)	Color ink cartridge (T005011)
Color(s)	Black	Cyan, magenta, and yellow
Print capacity*	1200 pages (A4, ISO/IEC 10561 letter pattern); 840 pages at 5% coverage at 360 dpi)	570 pages (A4, 5% coverage at 360 dpi)
Cartridge life	2 years from production date and up to within 6 months after opening package at 77 °C (25 °F)	
Storage temperature	-4 to 104 °F (-20 to 40 °C) 1 month at 104 °F (40 °C)	
Transit temperature	-22 to 140 °C (-30 to 60 °F) 1 month at 104 °F (40 °C) 120 hours at 140 °F (60 °C)	
Freezing temperature**	3.2 °F (-16 °C)	-0.4 °F (-18 °C)
Dimensions	1.1 (W) × 2.6 (D) × 1.6 (H) inches 28.9 (W) × 67.4 (D) × 41.8 (H) mm	2.1 (W) × 2.7 (D) × 1.6 (H) inches 54.0 (W) × 67.4 (D) × 41.8 (H) mm

* The print capacity may vary depending on how often you clean the print head and use the printer.

** The ink thaws and is usable after approximately 3 hours at 77 °F (25 °C).



To ensure good results, use genuine EPSON cartridges and do not refill them. Other products may cause damage to your printer not covered by EPSON's warranty.

Do not use an ink cartridge after the expiration date on the package.

Mechanical

Paper feed method	Friction with auto sheet feeder, rear entry
Sheet feeder capacity	Maximum 100 sheets of 17 lb (64 g/m ²) paper
Dimensions	
Storage	Width: 18.4 inches (467 mm) Depth: 11.7 inches (269 mm) Height: 7.8 inches (199 mm)
Printing	Width: 18.4 inches (467 mm) Depth: 23.4 inches (594 mm) Height: 12.8 inches (325 mm)
Weight	18.5 lb (8.4 kg) without the ink cartridges

Electrical

Specification	120 V Model	240 V Model*
Input voltage range	99 V to 132 V	198 V to 264 V
Rated frequency range	50 to 60 Hz	
Input frequency range	49.5 to 60.5 Hz	
Rated current	0.7 A	0.4 A
Power consumption	Approx. 30 W (ISO 10561 Letter Pattern)	

* Also designed for IT power systems with Phase to Phase voltage 220–240 V

Environmental

Temperature

Operation	50 to 95 °F (10 to 35 °C)
Storage	–4 to 104 °F (–20 to 40 °C) 1 month at 104 °F (40 °C)
Transit*	–4 to 140 °F (–20 to 60 °C) 120 hours at 140 °F (60 °C)

Humidity (without condensation)

Operation	20 to 80% RH
Storage*	5 to 85% RH

*Stored in shipping container

Safety Approvals

Safety standards	UL 1950 with D3, CSA C22.2 No. 950
EMC	FCC part 15 subpart B class B

Interfaces

Parallel interface

Forward channel

Specification	Description
Data format	8-bit parallel, IEEE-1284 compatibility mode
Synchronization	STROBE pulse
Handshake timing	BUSY and $\overline{\text{ACKNLG}}$ signals
Signal level	TTL compatible
Connector	57-30360 Amphenol connector or equivalent

Reverse channel

Specification	Description
Transmission mode	IEEE-1284 Nibble mode
Adaptable connector	57-30360 Amphenol connector or equivalent
Synchronization	Refer to the IEEE-1284 specification
Handshaking	Refer to the IEEE-1284 specification
Signal level	IEEE-1284 Level 1 device
Data transmission timing	Refer to the IEEE-1284 specification

Serial interface

Specification	Description
Standard	Based on RS-423
Synchronization	Synchronous
Bit rate	Approximately 1.8 Mbps
Handshaking	X-ON/X-OFF and DTR protocol
Word format	Data bit: 8 bits Parity bit: None Start bit: 1 bit Stop bit: 1 bit
Connector	8-pin mini-DIN
Recommended cable	ImageWriter® II cable (preferably Belkin brand)









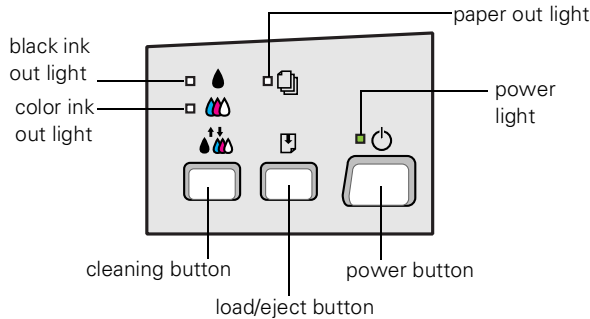

















USB interface

Specification	Description
Standard	Based on Universal Serial Bus Specifications Revision 1.0, Universal Serial Bus Device Class Definition for Printing Devices Version 1.0
Bit rate	12 Mbps (full speed device)
Data encoding	NRZI
Adaptable connector	USB Series B
Recommended cable length	6.5 feet (2.0 meters)

Control Panel

The four lights on your printer's control panel show the printer's status and alert you to problems like paper jams.



-  is on The  power light is on when the printer is on and ready to print. It flashes when the printer is receiving a print job or performing a maintenance operation, such as cleaning the print head.
-  flashes When the  paper out light flashes, you have a paper jam. Turn off the printer and gently pull out all paper. Make sure none of the sheets are curled, creased, old, stuck together, or too thin. Then reload the stack against the right edge guide and slide the left edge guide over to the paper's left edge. Then turn the printer on.
-  is on When the  paper out light comes on, your paper is out or incorrectly loaded. Make sure none of the sheets are curled, creased, old, stuck together, or too thin. Then reload the stack against the right edge guide and slide the left edge guide over to the paper's left edge. Press the  load/eject button to resume printing.
-  or  flash When an ink out light flashes, your ink supply is low. Make sure you have a replacement cartridge.
-  or  are on When an ink out light comes on, you need to replace the ink cartridge. See page 8 for instructions.
-  and  flash, and  and  are on When the  power and  paper out lights flash and the  black and  color ink out lights come on, jammed paper may be blocking movement of the print head. Turn off the printer, wait a few seconds, and turn it back on. If no paper ejects, turn off the printer, remove the jammed paper, and turn it on again. If the lights still flash or stay on, contact your dealer or EPSON.
-     flash When all the lights flash, your printer may have an internal error. Make sure you removed all the packing material as described on the unpacking sheet in your printer box. Then turn off the printer, wait a few seconds, and turn it on again. If the lights still flash or stay on, contact your dealer or EPSON.
-     are off When all the lights are off, the printer is not receiving power. Try these solutions:

 - Make sure the printer is turned on.
 - Turn off the printer, plug in the power cord securely, and turn on the printer again.
 - Make sure the outlet is not controlled by a switch or timer and is operable.

Installing an Ink Cartridge for the First Time

1. Plug the power cord into a grounded outlet.

 Don't use an outlet controlled by a wall switch or timer, or one that uses the same circuit as a large appliance. This may disrupt the power, which can erase the printer's memory or damage its power supply.

2. Remove the ink cartridges from their foil packages. Then pull off only the yellow part of the tape seal on the top of each cartridge. It is okay if a bit of the yellow tape remains on the cartridge. Don't pull off the blue part.



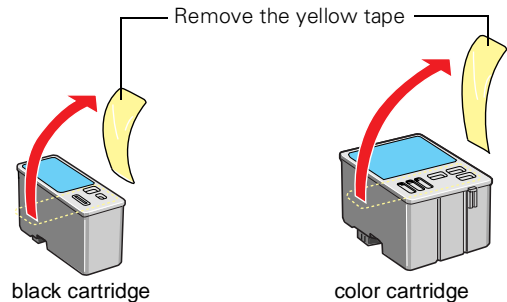

 You must remove the yellow tape seal from the top of the cartridge or you will permanently damage it. Don't remove the tape seal from the bottom.





 If ink gets on your hands, wash them thoroughly with soap and water. If ink gets in your eyes, flush them immediately with water.

3. Lower the output tray and open the printer cover.

 Be sure the tape securing the print head has been removed.

4. Press the  power button to turn on the printer. The  power light flashes, the  black and  color ink out lights come on, and the black ink cartridge holder moves slightly left to the installation position.

 Always use the  power button to turn the printer on or off. Never use an external switch, such as on a power strip.

5. Lift up the black ink cartridge clamp.

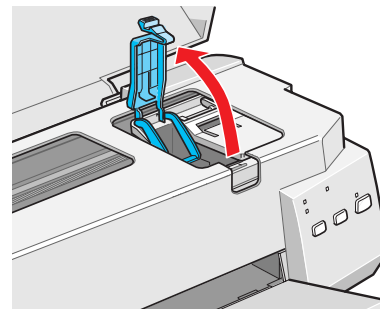

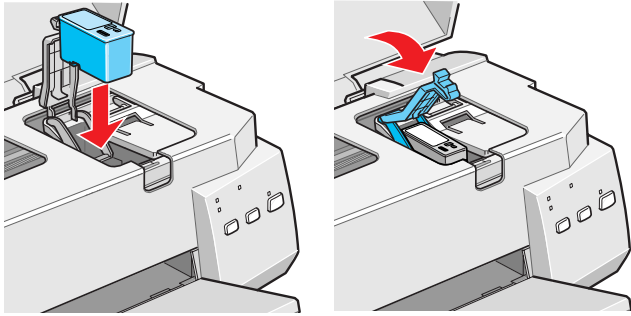

- Place the black ink cartridge in its holder with the label facing up and toward the back of the printer. Then press down the clamp until it locks into place.





- Press the  cleaning button to move the color ink cartridge holder into the installation position.

Note  If the print head doesn't move to the color ink cartridge installation position, hold down the cleaning button for three seconds until the print head moves to the color ink cartridge installation position.





- Repeat steps 5 and 6 to install the color ink cartridge.
- Press the  cleaning button to begin charging the ink delivery system and then close the printer cover.

Charging takes about two minutes. The  power light flashes, and the printer makes various sounds until it is finished. Don't turn off the printer or interrupt the charging process or it will start over and you'll use more ink than necessary. Charging is complete when the  power light stops flashing and is stays on.

Caution  Never turn off the printer when the  power light is flashing, unless the printer hasn't moved or made any noise for more than five minutes.

Testing the Printer

You can run a printer check to determine whether the problem comes from the printer itself or some other source. Follow these steps to run the printer check:

- Make sure both the printer and computer are turned off.
 - Disconnect the interface cable from the printer.
 - Make sure paper is loaded in the printer.
- Caution**  Load paper that's at least 8.27 inches (210 mm) wide. This prevents ink from spraying inside the printer and smudging your printouts.
- Hold down the  load/eject button, then press and release the  power button. Continue holding down the  load/eject button until the  power light starts to flash, then release it.

The printer prints one page showing its ROM version number, ink counter, and a nozzle check pattern in black, magenta, cyan, and yellow. Only the nozzle check pattern is shown below.

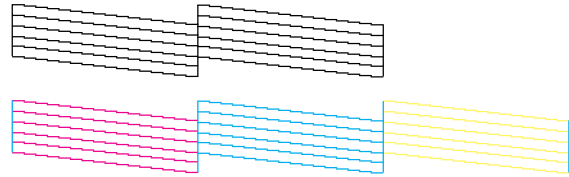

- To end the check, turn off the printer after it prints the check page. Then reconnect the interface cable and turn on your printer and computer.
 - If the results are satisfactory, the problem lies in your software settings, the interface cable, or your computer.
 - If the check page does not print correctly, you may have a problem with your printer. First try cleaning the print head (see page 10). Then try the suggestions in "Problems and Solutions" in the *Printer Basics* book or "Troubleshooting" in the *EPSON Stylus COLOR 900 Manual*.

Printing on Special Media

Whether you print on plain paper or special media, you need to make sure you select the correct Media Type setting in the printer software, as shown in the following table.

For this media name...	Then select this Media Type setting in your printer software...
Plain paper, letter size	Plain paper
Envelopes	
EPSON 360 dpi Ink Jet Paper	360 dpi Ink Jet Paper
EPSON Iron-On Cool Peel Transfer Paper ¹	
EPSON High Quality Ink Jet Paper	Photo Quality Ink Jet Paper
EPSON Photo Quality Ink Jet Paper	
EPSON Photo Quality Ink Jet Cards	
EPSON Photo Quality Self Adhesive Sheets	
EPSON Photo Paper	Photo Paper
EPSON Photo Quality Glossy Film	Photo Quality Glossy Film
EPSON Photo Stickers	
EPSON Ink Jet Transparencies	Ink Jet Transparencies

¹ Use the Flip Horizontal option to reverse your image before you print it—especially if it includes text—so the image will appear correctly when it’s transferred.

Media Loading and Handling Guidelines

Caution Don’t use any cleaning sheets included with special media; they may jam inside the printer.



The type of paper or other media you use is one of the most important factors in determining the quality of your printed output. The following tips will help you get the best results on any type of paper or other media:

- ❑ Always handle sheets by the edges, and don’t touch the printable surface.
- ❑ Be sure to load the printable (whiter or glossier) side of the media face up in the sheet feeder.

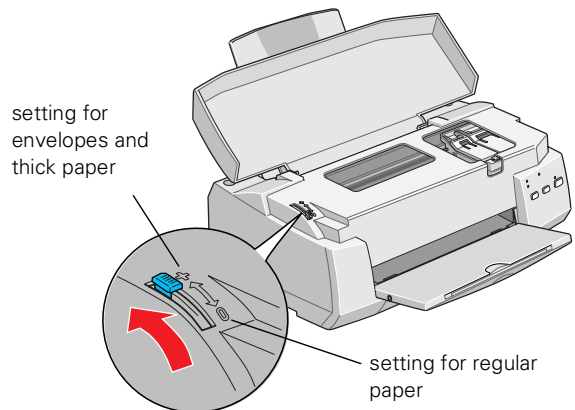
- ❑ Load paper only up to the arrow mark on the left edge guide.
- ❑ Remember to select the correct Media Type and Paper Size for your paper.
- ❑ If the special media has protective sheets between the sheets of media, be sure to remove the protective sheets before printing. After printing, cover the printed side of your media with these sheets before storing.
- ❑ Use ink jet papers within one year of purchase. Use glossy film and transparencies within six months. Return unused sheets and envelopes to their original packages as soon as possible. See “Paper” on page 2 for more media storage information.
- ❑ Set the thickness lever to the + position when you print on envelopes or if ink smears when you print on other thick media. Open the printer cover and position the lever as shown below. Then close the cover and print. (Make sure you return the lever to the 0 position before you print on regular media.)



Replacing an Ink Cartridge

When the  black or  color ink out light flashes, the indicated cartridge is low on ink. This is a good time to make sure you have a new cartridge. When the light stays on, the cartridge is empty and you need to replace it. You cannot print if either ink cartridge is empty.

You can also check your ink levels using Status Monitor 2 (not available for Windows 3.1). See your electronic *EPSON Stylus COLOR 900 Manual* for details.

Use these EPSON ink cartridges within six months of installing them and before the expiration date on the package:



- Black ink cartridge T003011
- Color ink cartridge T005011

Caution To ensure good results, use genuine EPSON ink cartridges and do not refill them. Other products may cause damage to your printer not covered by EPSON's warranty.

When you need new ink cartridges, contact your dealer or call EPSON Accessories at (800) 873-7766 (U.S. sales only). Or visit our web site at www.epsonsupplies.com (U.S. sales only). In Canada, please call (800) 873-7766 for dealer referral.

If you need to replace an ink cartridge before the lights flash (because the ink is too old, for example), see the instructions in "Replacing an Outdated Ink Cartridge" on page 9.

Removing and Installing Ink Cartridges



You can replace a cartridge when the  black or  color ink out light is either flashing or on. (If you perform these steps when both ink out lights are off, the printer cleans the print heads as described on page 10.)

Follow these steps to replace ink cartridges:

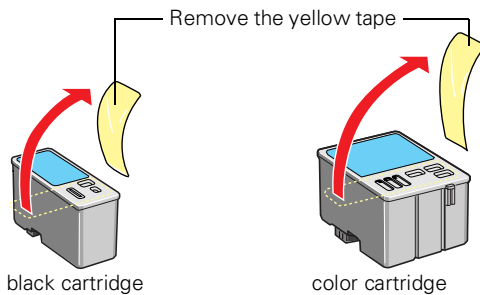
1. Remove the new ink cartridge from its packaging.
2. Remove *only* the yellow part of the tape seal on top as shown to the right. Don't pull off the blue portion or try to remove the clear seal underneath the cartridge.



Caution You must remove the yellow tape from the top of the cartridge or you will permanently damage it. Do not remove the clear seal from the bottom of the cartridge; ink will leak.

3. Make sure the printer is turned on and not printing, then open the printer cover.
4. Press the  cleaning button and hold it for about three seconds until the print head moves left and the  power light begins flashing. The print head moves to the black or color cartridge replacement position, depending on which ink cartridge is empty.

Caution To avoid damaging the printer, never move the print head by hand. Don't open the clamp or remove a cartridge except to replace it with a new one. Once you remove a cartridge, you can't reuse it, even if it contains ink.

5. Pull up the ink cartridge clamp. The cartridge rises up from its holder.

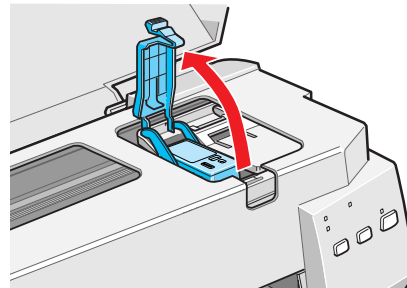



6. Lift the cartridge out of the printer and dispose of it carefully.

Warning If ink gets on your hands, wash them thoroughly with soap and water. If ink gets into your eyes, flush them immediately with water.

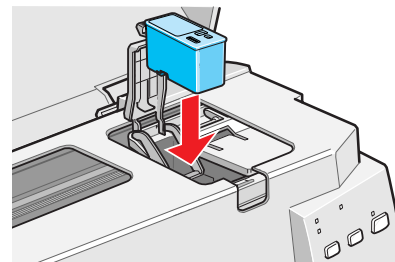
7. Lower the new ink cartridge into its holder with the label facing up and toward the back of the printer.





8. Press down the ink cartridge clamp until it locks in place.
9. If you need to replace the other ink cartridge, repeat steps 4 through 8 before continuing with step 10.
10. Press the  cleaning button and close the printer cover. The printer moves the print head and begins charging the ink delivery system.

The  power light flashes, and the printer makes various sounds. Charging takes about one minute. When it's finished, the  power light stops flashing and stays on.

Caution Never turn off the printer while the  power light is flashing, unless the printer hasn't moved or made noise for more than 5 minutes.

Replacing an Outdated Ink Cartridge



If an ink cartridge is more than six months old, you may need to replace it. How can you tell? You may notice that your printouts don't look as good as they used to. If print quality doesn't improve after cleaning and aligning the print head, you can replace one or both cartridges.

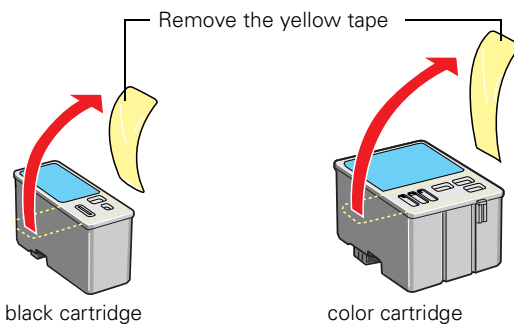

Follow these steps to replace an ink cartridge *before* the  black or  color ink out light is flashing or on:

1. Remove the new ink cartridge from its packaging.
2. Remove only the yellow part of the tape seal on top as shown below. Don't pull off the blue portion or try to remove the clear seal underneath the cartridge.



Caution  You must remove the yellow tape from the top of the cartridge or you will permanently damage it. Do not remove the clear seal from the bottom of the cartridge; ink will leak.

3. Make sure the printer is turned on and not printing, then open the printer cover.
4. Press the  load/eject button and hold it down for three seconds until the print head moves to the left to the black ink cartridge replacement position and the  power light begins flashing.
5. If you need to replace only the color ink cartridge, press the  load/eject button again until the print head moves to the color ink cartridge replacement position.

Note  If the print head moves to the home position instead of the color ink cartridge replacement position, try holding down the  load/eject button for three seconds until the print head moves to the black ink cartridge replacement position; then press the  load/eject button for half a second to move the print head to the color ink cartridge replacement position.

Caution  To avoid damaging the printer, never move the print head by hand. Don't open the clamp or remove a cartridge except to replace it with a new one. Once you remove a cartridge, you can't reuse it, even if it contains ink.

6. Pull up the ink cartridge clamp. The cartridge rises up from its holder.

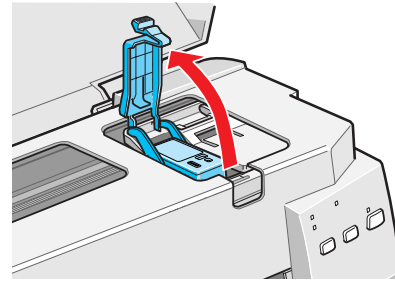



7. Lift the cartridge out of the printer and dispose of it carefully.

Warning  If ink gets on your hands, wash them thoroughly with soap and water. If ink gets into your eyes, flush them immediately with water.

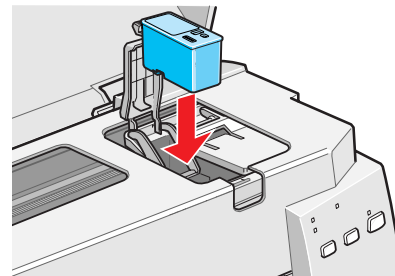

8. Lower the new ink cartridge into its holder with the label facing up and toward the back of the printer.



9. Press down the ink cartridge clamp until it locks in place.
10. Press the  load/eject button. The print head moves to the color ink cartridge replacement position. If you need to replace the color ink cartridge, repeat steps 6 through 9. Then continue with step 11.
11. Press the  load/eject button again and close the printer cover.

The printer moves the print head and begins charging the ink delivery system. The  power light flashes and the printer makes various sounds.

Charging takes about one minute. When it's finished, the  power light stops flashing and stays on.

Caution  Never turn off the printer while the  power light is flashing, unless the printer hasn't moved or made noise for more than 5 minutes.

Cleaning the Print Head

If your printed image is unexpectedly light or faint, or dots are missing from the image, you may need to clean the print head. This unclogs the nozzles so they can deliver ink properly.

Cleaning the print head uses ink, so clean it only if print quality declines. You can clean the print head in either of the following ways:





- ❑ Using the Head Cleaning utility in your printer software (when the printer is connected to a local port, not over a network)
- ❑ Using the printer's control panel buttons



Always wait until your document has finished printing before cleaning the print head.

 If you use special paper that comes with a cleaning sheet, don't use the cleaning sheet with your printer; it may jam inside the printer.

Using the Head Cleaning Utility

Follow these steps to run the Head Cleaning utility:

1. Make sure the printer is turned on but not printing, and both the  black and  color ink out lights are off.
2. Access the printer settings dialog box.
3. Click the Utility tab (Windows) or the  Utility icon (Macintosh).
4. On the Utility menu, click the **Head Cleaning** icon.
5. Follow the instructions on the screen to clean the print head. Cleaning takes a little over a minute, during which the printer makes some noise and the  power light flashes.

 Never turn off the printer while the  power light is flashing, unless the printer hasn't moved or made noise for more than 5 minutes.

6. When the  power light stops flashing, run a nozzle check to test the results and reset the cleaning cycle.





Make sure paper is loaded in the printer and click Print nozzle check pattern (Windows) or Confirmation (Macintosh). Then click Next. The nozzle check pattern prints; see "Examining the Nozzle Check Pattern" on page 11 for details.



7. If the nozzle check pattern is filled in completely, click Finish.

If the pattern is missing dots, click Clean to clean the print head again. Then try the suggestions in "Problems and Solutions" in the *Printer Basics* book or "Troubleshooting" in the *EPSON Stylus COLOR 900 Manual*.

Using the Control Panel

Follow these steps to clean the print head:

1. Make sure the printer is turned on but not printing, and both the  black and  color ink out lights are off.
2. Press the  cleaning button and hold it down for three seconds. Cleaning takes a little over a minute, during which the printer makes some noise and the  power light flashes.

 Never turn off the printer while the  power light is flashing, unless the printer hasn't moved or made noise for more than 5 minutes.

3. After the  power light stops flashing, print a page to test the print quality and reset the cleaning cycle.

If you're connected directly to the printer, run a nozzle check. Go to step 4.

If you're using DOS or printing over a network, open an application and print a document containing black and color data. Then go to step 8.

4. Start an application, open a document, and access the printer settings dialog box.
5. Click the Utility tab (Windows) or the  Utility icon (Macintosh). You see the Utility menu.
6. Make sure paper is loaded in the printer, click the Nozzle Check icon, and click Next. The nozzle check pattern prints on the printer; see "Examining the Nozzle Check Pattern" on page 11 for details.
7. If the nozzle check pattern is filled in completely, click Finish.
If the pattern is missing dots, click Clean to clean the print head again.
8. If you don't see any improvement after cleaning two or three times, then try the suggestions in "Problems and Solutions" in the *Printer Basics* book or "Troubleshooting" in the *EPSON Stylus COLOR 900 Manual*.

Examining the Nozzle Check Pattern

Examine the nozzle check pattern you print. It should look something like this:

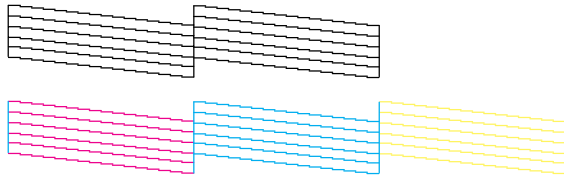

Each staggered horizontal and straight vertical line should be complete, with no gaps in the dot pattern. If your printout looks okay, you're done. If any dots are missing, as shown below, clean the print head again; see page 10 for instructions.

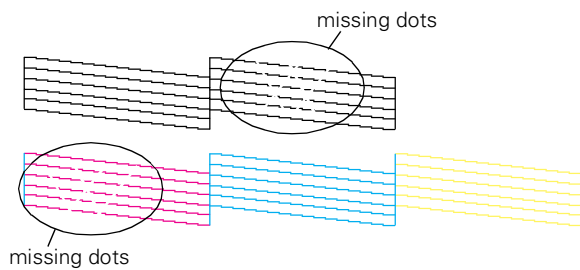

Aligning the Print Head

If your printouts contain misaligned vertical lines, you may need to align the print head. Your printer must be connected to a local port, not on a network, to use the Print Head Alignment utility.

If you are using DOS, follow the instructions in "Aligning the Print Head Using the Control Panel Buttons" instead.

Follow these steps:

1. Make sure the printer is turned on and letter-size paper is loaded.





Caution Load paper that's at least 8.27 inches (210 mm) wide. This prevents ink from spraying inside the printer and smudging your printouts.

For the best results, load EPSON ink jet paper in the printer whenever you check the print head alignment.



2. Access the printer settings dialog box.
3. Click the Utility tab (Windows) or the  Utility icon (Macintosh). You see the Utility menu.
4. Click the Print Head Alignment icon.
5. Follow the instructions on the screen to print a test page and select the correct alignment.

Aligning the Print Head Using the Control Panel Buttons

If you cannot use the print head alignment utility program that came with your printer, follow these steps to align the print head.

1. Make sure that letter-size or A4-size paper is loaded in the sheet feeder.
2. While holding down the  cleaning button, press the  power button to turn on the printer. Then release both buttons.
3. The  paper out light flashes for about three seconds. While it is flashing, press the  load/eject button.

The printer prints a sheet of instructions in English, French, German, Italian, Spanish, and Portuguese explaining how to align the print heads. Follow these instructions.

Note  If the  load/eject button isn't pressed while the  paper out light is flashing, the printer enters default-setting mode. If this happens, turn off the printer and repeat steps 2 and 3.

4. After aligning the print head, turn off the printer to exit print head alignment mode.

Cleaning the Printer

To keep your printer working at its best, you should clean it several times a year. Follow these steps:

1. Turn off the printer, unplug the power cord, and disconnect the printer cable.
2. Remove all the paper from the sheet feeder.
3. Clean the exterior of the printer with a soft, damp cloth.
4. Clean ink out of the printer's interior with a soft, damp cloth.

Caution  Don't touch the gears inside the printer.

Never use alcohol or thinner for cleaning; they can damage the printer components and case.

Don't use a hard or abrasive brush.

Don't get water on the printer components and don't spray lubricants or oils inside the printer.

Don't use any cleaning sheets included with special media; they may jam inside the printer.

Transporting the Printer

If you move your printer some distance, you need to prepare it for transportation in its original box. Follow these steps:



To avoid damage, always leave the ink cartridges installed when transporting the printer.

Be sure to remove the tape used in step 4 after installing the printer in its new location.

1. Turn on the printer and wait until the print head locks in the far right position. Then turn off the printer.
2. Unplug the power cord from the electrical outlet. Then disconnect the printer cable from the printer.
3. Remove any paper from the printer and remove the paper support.
4. Open the printer cover. Secure the ink cartridge holder to the printer with tape as shown, then close the printer cover.

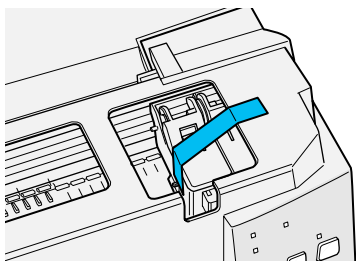

5. Push in the output tray extensions and close the tray.
6. Repack the printer and attachments in the original box using the protective materials that came with it. See the unpacking sheet that was packed with your printer.

Be sure to keep the printer level as you transport it. If you notice a decline in print quality after transporting the printer, clean the print head (see page 10); if output is misaligned, align the print head (see page 11).

Related Documentation

TM-SC900	EPSON Stylus COLOR 900 Service Manual
PL-SC900	EPSON Stylus COLOR 900 Parts Price List
CPD-7737	EPSON Stylus COLOR 900 Printer Basics
CPD-7738	EPSON Stylus COLOR 900 Start Here
ESC9001298	EPSON Stylus COLOR 900 Manual (Adobe Acrobat format, pdf)